

# **Forest Practices Board Manual**

# Board Manual

<b>Section 1</b>	
Method For Determination of Adequate Shade Requirements on Streams . . . . .	M1
<b>Section 2</b>	
Channel Migration Zones and Bankfull Channel Features . . . . .	M2
<b>Section 3</b>	
Guidelines for Forest Roads . . . . .	M3
<b>Section 4</b>	
Guidelines for Clearing Slash and Debris from Type Np and Ns Water . . . . .	M4
<b>Section 5</b>	
Guidelines for Forest Practices Hydraulic Projects . . . . .	M5
<b>Section 6</b>	
Guidelines for Determining Acceptable Stocking Levels . . . . .	M6
<b>Section 7</b>	
Guidelines for Riparian Management Zones (RMZ) (Measuring Widths and Tree Counts) . . . . .	M7
<b>Section 8</b>	
Guidelines for Wetland Delineation . . . . .	M8
<b>Section 9</b>	
Guidelines for Wetland Replacement by Substitution or Enhancement . . . . .	M9
<b>Section 10</b>	
Non-Native Wetland Plant Species . . . . .	M10
<b>Section 11</b>	
Standard Methodology for Conducting Watershed Analysis . . . . .	M11
<b>Section 12</b>	
Guidance for Application of Forest Chemicals . . . . .	M12
<b>Section 13</b>	
Guidelines for Determining Fish Use for the Purpose of Typing Waters . . . . .	M13
<b>Section 14</b>	
Survey Protocol for Marbled Murrelets . . . . .	M14
<b>Section 15</b>	
Guidelines for Estimating the Number of Marbled Murrelet Nesting Platforms . . . . .	M15
<b>Section 16</b>	
Guidelines for Evaluating Potentially Unstable Slopes and Landforms . . . . .	M16
<b>Section 17</b>	
Guidelines for the Small Forest Landowner Forestry Riparian Easement Program . . . . .	M17
<b>Section 18</b>	
Guidelines for Rivers and Habitat Open Space Program . . . . .	M18
<b>Section 19</b>	
Guidelines for Hardwood Conversion . . . . .	M19
<b>Section 20</b>	
Guidelines for Financial Assurances . . . . .	M20
<b>Section 21</b>	
Guidelines for Alternate Plans . . . . .	M21
<b>Section 22</b>	
Guidelines for Adaptive Management Program . . . . .	M22
<b>Section 23</b>	
Guidelines for Field Protocol to Locate Mapped Division Between Stream Types and Perennial Stream Identification . . . . .	M23
<b>Section 24</b>	
Guidelines for the Interim Modification of Bull Trout Habitat Overlay . . . . .	M24
<b>Section 25</b>	
Guidelines for Bull Trout Presence Survey Protocol . . . . .	M25
<b>Section 26</b>	
Guidelines for Large Woody Debris Placement Strategies . . . . .	M26

# Section 1

## Method For Determination of Adequate Shade Requirements on Streams

<b>PART 1. STEPS</b> .....	<b>1</b>
<i>Map 1.1: Eastside/Westside</i> .....	3
Map 1.2: Eastern Washington Bull Trout Overlay .....	3
Figure 1.1 Eastern Washington .....	4
Figure 1.2 Western Washington .....	5

### PART 1. STEPS

1. **Is any harvest planned within the inner zone of a riparian management zone** on a flowing Type 1, 2, or 3 water which is also within 75 feet of the bankfull width (BFW) or channel migration zone (CMZ) of the stream, whichever is greater? (See **WAC 222-30-021 and 022**). (Note: “flowing” refers to waters which are not seasonal, or dry from July - September.) (Note: In the case of exempt 20-acre parcels, the maximum width Riparian Management Zone as described under **WAC 222-30-023** is to be substituted for the inner zone within 75 feet of the bankfull width or CMZ in this and subsequent paragraphs). If the answer is no, the temperature method does not apply. If the answer is yes, proceed to step two.
  
2. **Determine whether harvest unit is in Eastern or Western Washington** relative to the Cascade divide.

#### See map 1.1: Eastside/Westside (pg. M1-3)

If harvest unit is in Western Washington, apply the Temperature Screens beginning with step 4.

If harvest unit is in Eastern Washington, is it within the bull trout habitat overlay?

If yes . . . proceed to step 3.

If no . . . proceed to the Temperature Screens beginning with step 4.

3. **Bull Trout Habitat Overlay:** When the harvest unit is within the bull trout habitat overlay (eastside only), all available shade must be retained within 75 feet of the bankfull width or CMZ, whichever is greater. All available shade would be equivalent to the existing pre-harvest canopy closure, which is measured with the densiometer using the method described below. Proceed to steps 5 through 8.

#### See map 1.2: Eastern Washington Bull Trout Overlay (pg. M1-3)

4. **Temperature Screens:** Determine the water quality stream temperature classification, 16 degrees C or 18 degrees C (**WAC 173-201A**). A map displaying this information is available from the Department of Natural Resources (DNR). Determine the elevation at the midpoint of the stream reach within the proposed harvest area. Apply this information to

the following nomographs (pgs. M1-4 and M1-5) to derive the minimum canopy (shade) required after harvest (**WAC 222-30-040(2)**).

5. **To determine the average pre-harvest canopy closure** for the stream reach or CMZ, take evenly spaced plots every 75 feet. Begin 75 feet in from unit boundary. The minimum number of plots required is five. Average canopy closure for all plots taken to obtain average reach pre-harvest canopy closure.
6. **Determine the percent of canopy closure** at each plot while standing at the appropriate location described below:

If there is a CMZ, stand at the edge of the CMZ.

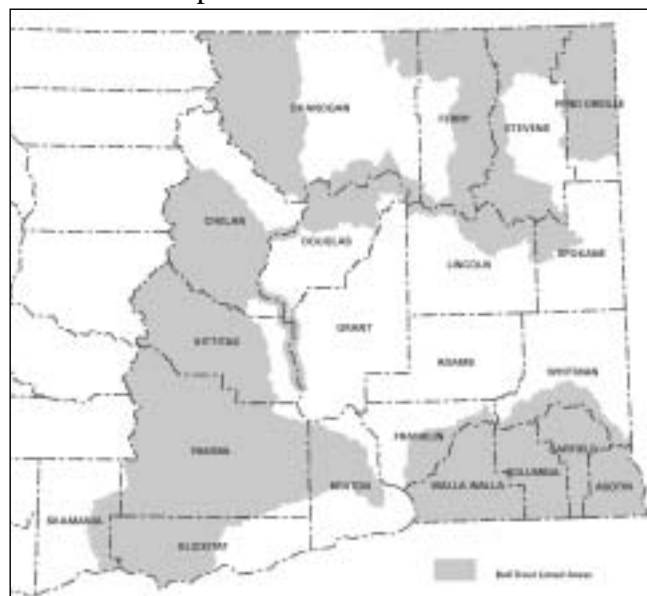
If there is no CMZ and the flows are low enough, stand in the middle of the channel. If flows are too high, stand at the edge of the BFW.

7. **How to use a densiometer for measuring canopy closure:** Hold the instrument level 12" - 18" in front of your body at elbow height. You should see the reflection of your head just outside of grid in the mirror. Assume four equal spaced dots in each square and systematically count dots equivalent to quarter-square canopy openings. Repeat this procedure four times per plot taking measurements while facing upstream, downstream, and at the right and left banks. Average the four dot counts per plot to get the percent canopy opening for the plot. Multiply the average number of dots by 1.04 and subtract the results from 100 to obtain the percent of area occupied by canopy. (For canopy openings greater than 50%, it may be easier to directly count the area covered by canopy.) Leaf-out must be estimated when leaves are not present.
8. **To estimate post-harvest canopy closure,** repeat the canopy closure calculations for all plots and take the average for the reach, this time estimating the effect of the proposed canopy removal. The crowns of individual trees must be identified visually by standing at one of the locations described in Step 6, and the effect of their removal on the percent canopy closure must be calculated. (It may be easier to flag the RMZ line and/or the desired post-harvest leave trees, at least at each plot, prior to estimating post-harvest canopy closure.)
9. **When outside the bull trout overlay,** harvesting within the inner zone on a flowing Type 1, 2, or 3 water, which is also within 75 feet of the bankfull width or CMZ of the stream, whichever is greater, cannot reduce canopy closure below the minimum derived from the nomograph in Step 4. Leave trees may be selected in different combinations to meet canopy closure requirements, provided the RMZ leave tree requirements are also met (**WAC 222-30-021 and 022**).
10. **Where the existing pre-harvest canopy closure is less than the amount required from the nomograph,** all-available shade must be retained within 75 feet of the bankfull width or CMZ, whichever is greater. (See definition for "all available shade" in Step 3.) Where the projected post-harvest canopy closure is less than the nomograph requires, proposed canopy removal must be reduced accordingly until the required canopy closure is met.

11. **Water Quality Standards:** If natural conditions exceed water quality temperature standards (16 or 18 degrees C, according to class of water), then no management-related temperature increases over 0.3 degrees C will be allowed. If water quality temperature standards are being met, then no management-related temperature increase can exceed 2.8 degrees C; however, in no case, can the temperature go above either 16 or 18 degrees accordingly. Determine if the harvest will remove more than 25% canopy cover. If so, the “TFWTEMP” computer model (current version approved by the Board) should be run to determine if the maximum allowable water temperature increase will be exceeded. To use the “TFWTEMP” computer model contact the Washington Department of Ecology or DNR.
  
12. **The nomograph and model used in this method are empirically based tools.** As new data becomes available and is reviewed by CMER, or water quality standards change, these tools may be updated and modified by the Board.



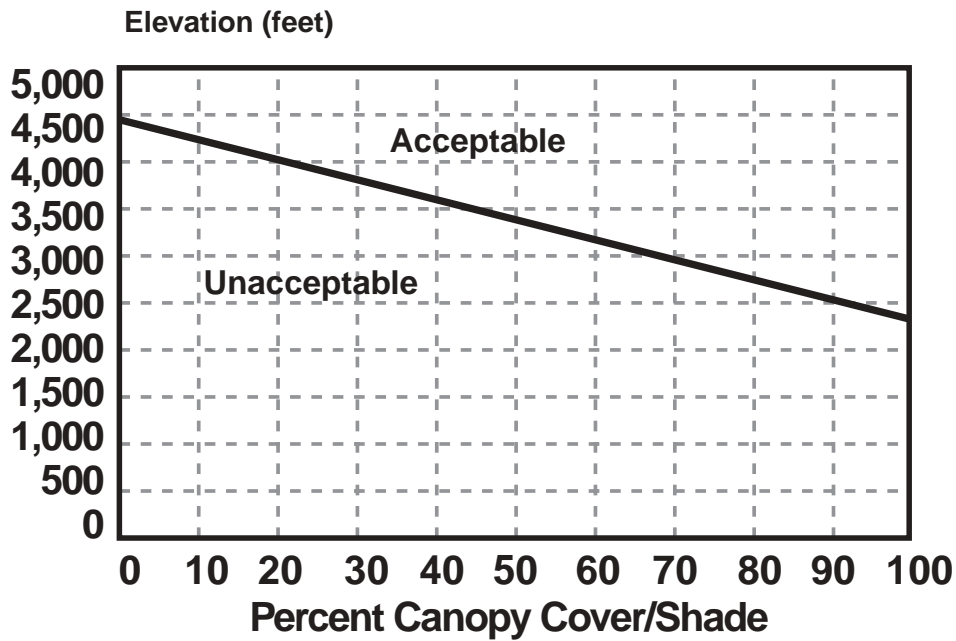
Map 1.1: Eastside/Westside



Map 1.2: Eastern Washington Bull Trout Overlay

### Eastern Washington Canopy Cover Required 16 degrees C

---



### Eastern Washington Canopy Cover Required 18 degrees C

---

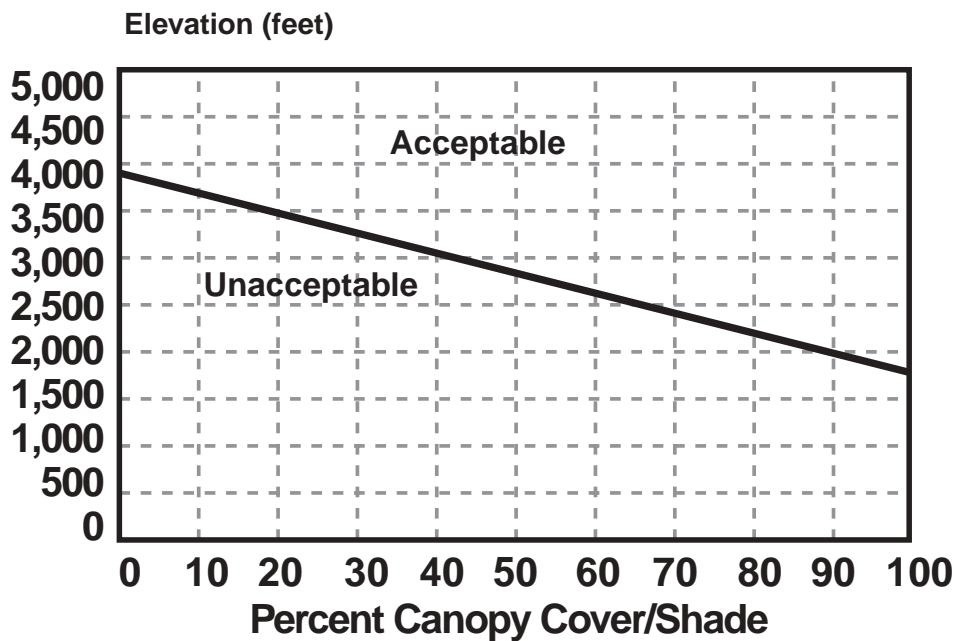
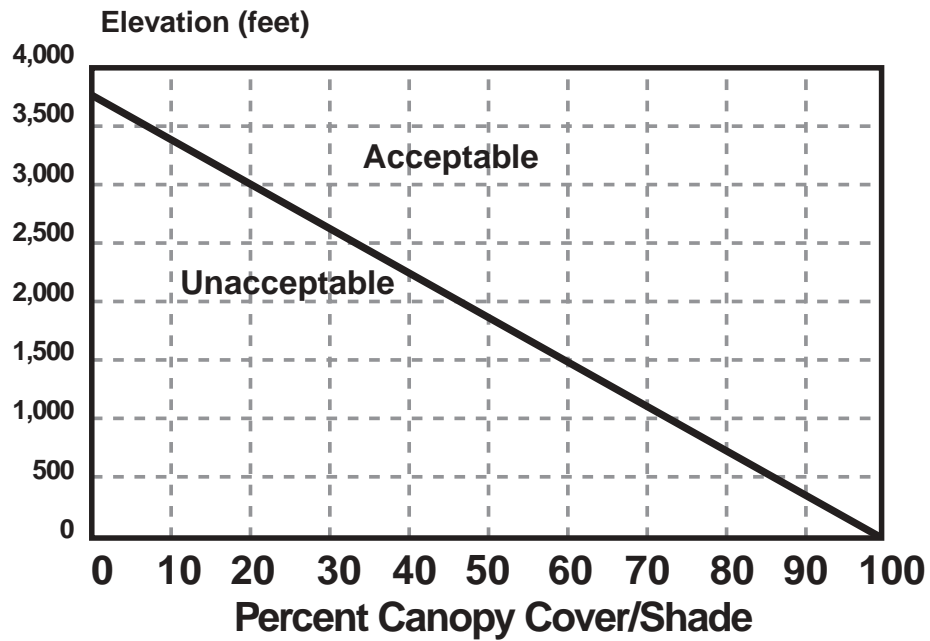


Figure 1.1 Eastern Washington

### Western Washington Canopy Cover Required 16 degrees C

---



### Western Washington Canopy Cover Required 18 degrees C

---

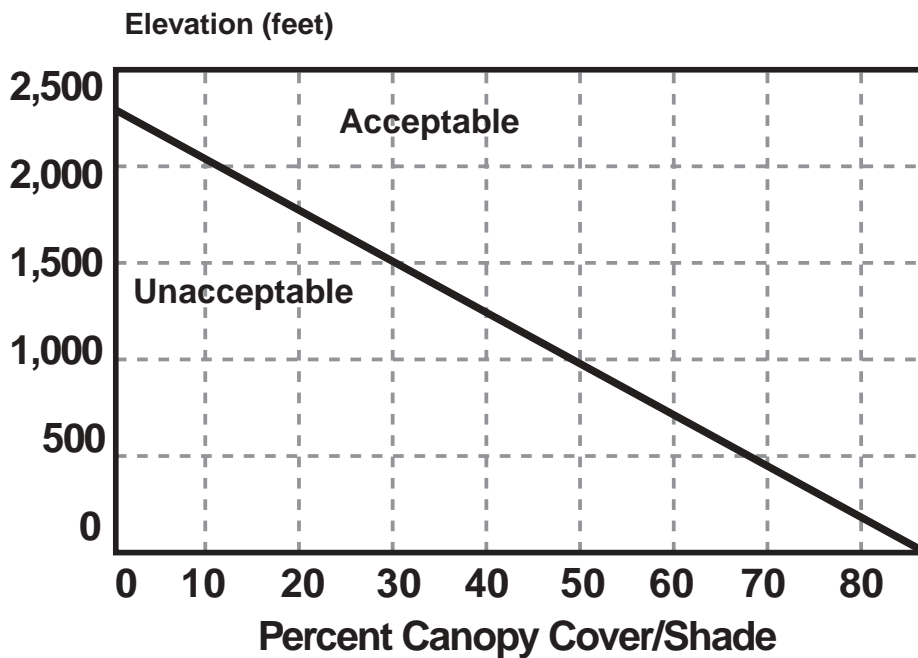


Figure 1.2 Western Washington





## Section 2

### Standard Methods For Identifying Bankfull Channel Features and Channel Migration Zones

The purpose of this section of the board manual is to help identify the point along the stream where measurement of the riparian management zone (RMZ) begins. The section is divided into two parts that describe how to identify bankfull channel features and channel migration zones (CMZ), respectively. *For streams that show evidence of migration as described in this manual, the RMZ begins at the outer edge of the CMZ. For streams without such migration, the RMZ begins at the outer edge of the bankfull width.*

<b>PART 1. BANKFULL CHANNEL FEATURES .....</b>	<b>3</b>
1.1 Background .....	3
1.2 Identifying Bankfull Width and Bankfull Depth .....	4
Figure 1. Indicators for determining bankfull width (adapted from Pleus and Schuett-Hames, 1998) .....	4
1.3 Measuring Bankfull Width and Depth.....	5
Figure 2. Measurement of bankfull depth using the 10% cell method (adapted from Pleus and Schuett-Hames, 1998) .....	5
<b>PART 2. CHANNEL MIGRATION ZONES .....</b>	<b>6</b>
2.1 Introduction.....	6
2.2 Determining if Channel Migration Is Present .....	6
Figure 3. Valley confinement using a topographic map.....	9
Figures 4, 5, 6a, and 6b. Examples of channel and floodplain features: 1) obvious channel movement; 2) high sinuosity; 3) secondary channels; 4) braiding; 5) anabranching (multiple channels around vegetated islands); 6) large gravel bars; 7) young disturbance vegetation; 8) eroding bank.....	10
Figures 7a and 7b. Bank erosion between two sets of aerial photographs. ....	11
Figures 8 and 9. Confined valley and an unconfined valley.....	13
Figure 10. Erosion-resistant bank.....	15
Figure 11. Root-stabilized bank. ....	15
Figure 12. Root exposure as an indication of bank erosion.....	16
Figure 13a. and Figure 13b. Accumulation of eroded material (Figure 13a) and blocks of material (Figure 13b) at base of bank.....	16
Figure 14. Undercut stream bank. ....	16
Flow Chart for Determining Channel Migration .....	20
2.3 Delineating the Channel Migration Zone .....	21
Figure 15. Valley and floodplain features identified and evaluated for inclusion into the CMZ delineation. All zones are not necessarily present along all river segments. ....	22
Figure 16. Channel hierarchy from watershed to segment to reach scale. ....	23
Figure 17. A sequence of historical channel maps and photos: 1895 General Land Office Survey; 1939 USGS aerial photograph; 1952 15' USGS topographic quadrangle map; 1981 7 ½' USGS topographic quadrangle map; 1994 DNR orthophoto; and a field map (modified from O'Connor et al., 2003). ....	26
Figures 18a and 18b. Channel avulsion that occurred between two photo years. ....	27

Figure 19. CMZ disconnected by a public right-of-way. ....	30
Figure 20. Simple floodplain abuts valley walls CMZ scenario in plan view. ....	32
Figure 21. Cross sectional of the simple floodplain CMZ scenario. ....	33
Figure 22. Simple floodplain with terraces CMZ scenario in plan view. ....	33
Figure 23. Cross sectional of the simple floodplain with terraces CMZ scenario. ....	34
Figure 24. Complex floodplain CMZ scenario in plan view. ....	35
Figure 25. Cross sectional of the complex floodplain CMZ scenario. ....	35
Figure 26. Environment where alluvial fans form (National Research Council, 1996). ....	36
Figure 27. Braided river. ....	37
Figure 28. Progressive channel migration shown in cross section (Drawing: Knighton, 1998). ....	39
Figure 29. Progressive channel migration shown in plan view (Drawing: Mount, 1995). ...	39
Figure 30. Method 1: CMZ equals area within amplitude of meander bends. ....	40
2.4 CMZ Review and Additional Analyses. ....	41
2.5 Technical Background. ....	41
Figure 31. Independent controls on channel morphology and the dependent variables subject to change or adjustment (Diagram: modified from Montgomery and Buffington 1993). ....	42
Figure 32. Watershed map showing the principal zones of sediment behavior (Church, 2002). ....	43
Figure 33. Comparison of an idealized river (gray line) to the more realistic profile (black line) from headwaters to mouth. ....	44
Figure 34. Different conceptual models of how rivers change in the downstream direction (Drawing: Poole, 2002). ....	44
Figure 35. The channel network shown as a series of confined and unconfined reaches. Additionally, hydrologic exchange pathways are shown for the longitudinal, lateral and vertical dimensions (Drawing: Ward et al., 2002). ....	44
Figure 36. The four dimensions typically used to describe the morphology of a river: ....	45
Figure 37. Simplified valley cross section of alluvial valley bottom illustrating the effects of various stages on channel width. ....	46
Figure 38. Progressive channel migration shown in cross section (Drawing: Knighton, 1998). ....	47
Figure 39. Progressive channel migration shown in planview (Drawing: Mount, 1995). ...	48
Figure 40. Types of channel changes (modified from Schumm, 1985). ....	49
Figure 41. Idealized alluvial fan environment (National Research Council, 1996). ....	51
Figure 42. Cchannel incision and vertical channel change over time (Drawing: modified from Simon and Hupp 1986). ....	54
Figure 43. Cross section and planview illustration of terrace development and valley downcutting and subsequent filling (Drawing: adapted from Mount, 1995). ....	54
Figure 44. Single and Anabranching River Patterns (Drawing: modified from Nanson and Knighton, 1996) ....	56
Figure 45. Hierarchical stream classification (Drawing: Frissell et al., 1986; adapted from Kondolf et al., 2003). ....	58
Figure 46. Summary of variables linked to channel adjustment, morphology and classification in floodplain alluvial rivers (Chart: Nanson and Knighton, 1996; after Gurnell and Petts, 2002). ....	59
2.6 Summary. ....	60

2.7 Glossary .....	60
2.8 References.....	64

## PART 1. BANKFULL CHANNEL FEATURES

If you determine no channel migration zone (CMZ) is present, the next step is to identify the bankfull width of the stream.

### 1.1 Background

Forest practices rule, WAC 222-16-010, provides the following definition for bankfull depth and width:

“Bankfull depth” means the average vertical distance between the channel bed and the estimated water surface elevation required to completely fill the channel to a point above which water would enter the floodplain or intersect a terrace or hillslope. In cases where multiple channels exist, the bankfull depth is the average depth of all channels along the cross section.

“Bankfull width” means:

- For streams - the measurement of the lateral extent of the water surface elevation perpendicular to the channel at bankfull depth. In cases where multiple channels exist, bankfull width is the sum of the individual channel widths along the cross section.
- For lakes, ponds, and impoundments – line of mean high water.
- For tidal water – line of mean high tide.
- For periodically inundated areas of associated wetlands – line of periodic inundation, which will be found by examining the edge of inundation to ascertain where the presence and action of waters are so common and usual, and so long continued in all ordinary years, as to mark upon the soil a character distinct from that of the abutting upland.

If a CMZ is not present, measurement of the riparian management zone (RMZ) begins at the outer edge of the bankfull width. Guidance for measuring bankfull width and depth in this manual refers to a measurement of channel dimensions at bankfull flow and not for other parts of the bankfull width definition: b) lakes, ponds, and impoundments; c) tidal water (tidally influenced channels); or d) periodically inundated areas of associated wetlands. See Board Manual Section 8 for guidance.

### **Bankfull Channel Dimensions and Flood Frequencies**

*The width and depth of a stream channel reflects flow magnitudes and sediment load over time. Channel size is established by the smaller, more frequent flood events that over time accomplish the greatest volume of sediment transport. While a 100-year recurrence interval flood moves more material than a two-year recurrence interval flood, the cumulative sediment movement from fifty two-year floods over 100 years is usually far greater than the one 100-year flood. The bankfull flow typically represents a discharge that is reached in most years.*

### 1.2 Identifying Bankfull Width and Bankfull Depth

The edge of the bankfull channel typically corresponds to the start of the floodplain. A floodplain receives floodwaters in most years, but is generally vegetated by perennial plants and trees. This vegetation often reflects repeated flow-related disturbance and may not support mature trees. The following primary indicators are used to characterize the start of the floodplain:

- **Topography** - A berm or other break in slope from the channel bank to a flat valley bottom, terrace or bench;
- **Vegetation** - A change in vegetation from bare surfaces or annual water-tolerant species to perennial water-tolerant or upland species; and
- **Sediment Texture** - A change in the size distribution of surface sediments (e.g., gravel to fine sand) (Figure 1).

Field determination of the bankfull channel edge generally relies on two or more of the following:

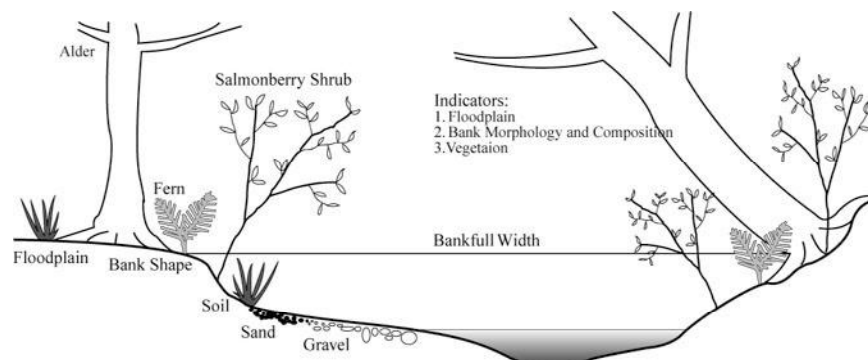


Figure 1. Indicators for determining bankfull width (adapted from Pleus and Schuett-Hames, 1998).

If physical obstructions, such as log jams, or a lack of indicators prevent accurate identification of the bankfull width at a particular point, move to the nearest place where identification is feasible. In cases where the outer edge of the bankfull width is easier to determine on one side of the channel than the other, simply identify the bankfull width on one side and project across at that same elevation to the other bank.

In streams where the substrate is dominated by boulders or bedrock or where the channel is tightly confined, a distinct floodplain may not exist. In these situations, you will have to rely on secondary indicators, such as vegetation or other evidence of flood flows to determine the bankfull width. These indicators may include:

- A change in vegetation from bare surfaces or annual water-tolerant species to perennial upland or water-tolerant shrubs and trees;
- Bare areas associated with scour around woody debris or other obstructions;
- The top of point bars; or
- The lowest elevation at which fine organic debris is caught on brush or trees.

One approach to help identify the bankfull edge is to evaluate the indicators discussed previously from within the bankfull channel looking towards the suspected bankfull edge. Identify the point

where the certainty of being within the bankfull channel is less than 100%. Then, repeat this process, but begin on the floodplain and work towards the channel. This exercise should help narrow the focus to the area between the two markings where more subtle indicators of the bankfull edge may be found (Pleus and Schuett-Hames, 1998).

### 1.3 Measuring Bankfull Width and Depth

Once the edges of the bankfull channel are determined, one can easily measure bankfull width and the average bankfull depth. A tape measure and measuring rod (such as a surveyor's rod) are useful to make these measurements. String wrapped around wooden stakes may also be helpful to more easily mark reference points. The most common situations where these measurements will be helpful are when one needs to:

- Determine a width category for the RMZ rules (see Board Manual Section 7); or
- Determine functional large woody debris size for CMZs in meandering rivers or as part of the LWD placement protocol. See Board Manual Section 26.

To measure bankfull width, attach or have an assistant hold one end of the tape at the bankfull edge and extend the tape to the other edge of the bankfull channel. The outlets of overflow swales, small islands, log jams, backwater eddies or regularly flooded adjacent wetlands may all occur within the bankfull width. In cases where multiple channels exist, such as around a small island, bankfull width is the sum of the individual channel widths along the cross section.

Bankfull depth is the average distance from the channel bed to the estimated water surface elevation at bankfull flow. With the measuring tape extended across the channel, divide the bankfull width into ten evenly spaced sections (Figure 2). Depth measurements are taken at the center of each section. The average bankfull depth is then calculated by dividing the sum of all depth measurements by the number of measurements.

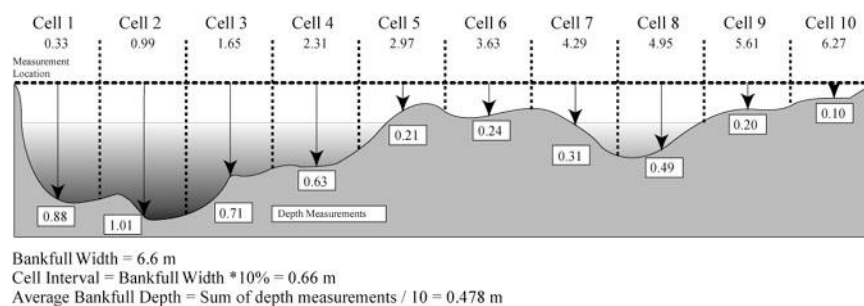


Figure 2. Measurement of bankfull depth using the 10% cell method (adapted from Pleus and Schuett-Hames, 1998)

When characterizing the average bankfull width or depth for a certain stream length, take enough cross sectional measurements to provide an accurate representation of the general channel size. For channels that are obviously greater or less than 10 feet in width in Western Washington or greater or less than 15 feet in Eastern Washington, bankfull width measurements are not necessary. For channels widths that are not obviously discernible, bankfull width should be measured with at least 10 evenly spaced measurements over a representative section of at least 500 linear feet. Please refer to the TFW monitoring program's "Method Manual for Reference

Point Surveys” for more detailed information on determining bankfull width or depth (Pleus and Schuett-Hames 1998).

## **PART 2. CHANNEL MIGRATION ZONES**

### 2.1 Introduction

This manual is a technical supplement to the forest practices rules to assist landowners, foresters and others in determining whether a channel migration zone (CMZ) is present in a proposed forest practice activity area and, if so, to assist in the delineation of the CMZ. The forest practices rules define a CMZ as *“the area where the active channel of a stream is prone to move and this results in a potential near-term loss of riparian function and associated habitat adjacent to the stream, except as modified by a permanent levee or dike. For this purpose, near-term means the time scale required to grow a mature forest”* (WAC 222-16-010).

This manual section is organized to first help the user distinguish if the stream segment adjacent to a proposed forest practices activity is prone to migration (Part 2.2). Once it has been determined that channel migration has historically occurred or is occurring along the segment, Part 2.3 provides technical guidelines and likely scenarios for CMZ delineation. Part 2.4 provides possible CMZ review steps and a description of where and what type of additional analyses may be necessary. A glossary of technical terms used in this manual can be found in Part 2.6.

In delineating a CMZ, we attempt to anticipate the type and scale of large channel-changing events that may occur during a 25, 50, or 100-year flood event. The scale of events for which we have some predictive capability. Careful evaluation of field evidence will help the landowner determine the limit of channel migration over the near-term future. An understanding of general river processes may also be helpful to the landowner. To this end, technical background (Part 2.5) is included, and users of this manual are encouraged to become familiar with the concepts offered.

### 2.2 Determining if Channel Migration Is Present

Prior to delineating a CMZ adjacent to any harvest unit, one first needs to determine if channel migration has historically occurred. Evidence that channel migration is occurring now or has occurred in the past can be observed by viewing topographic maps and aerial photographs and by observing lines of evidence on field inspections. This part describes the two distinct steps to perform this determination; 1) an Office Review and 2) a Field Evaluation.

1. Office Review to Determine Channel Migration: The purpose of the Office Review is to look for obvious indicators of past channel movement, to gather information about channel features, and to facilitate and complement the field evaluation. Use the CMZ Office Review Form in conjunction with historical and current aerial photography and topographic maps to do this review. The text following the form provides technical guidance for questions on the form.

### CMZ Office Review Form

Collect appropriate tools, including USGS 7 ½' quadrangle topographic maps, current and historic aerial photographs (oldest and some years in between oldest and most recent is recommended). List the source, year, and scale of all historical information used (for example, DNR aerial photograph, 1995, 1:12000):

Examine upstream and downstream from the harvest unit boundaries as necessary to determine stream behavior. If the stream of interest is not mapped on the USGS topographic map, or if channel features are too small to be visible on the aerial photographs, proceed to the Field Evaluation Form.

Question 1: Do you observe obvious channel movement between aerial photograph years?

No. Go to Question 2.

Yes. Proceed directly to Part 2.3 Delineating the Channel Migration Zone.

Question 2: Using Board Manual guidance, evaluate valley confinement from USGS Topographic Map or aerial photographs.

\_\_\_\_\_ Valley floor is significantly wider than the channel. Channel migration may be occurring.

\_\_\_\_\_ Valley floor is very narrow, obviously less than twice as wide as the channel. If you can clearly see this circumstance on the aerial photographs, it is unlikely that channel migration is occurring.

In both cases, proceed to Question 3.

Question 3: On the aerial photographs, do you observe:

<u>Yes</u>	<u>No</u>	
_____	_____	Secondary Channels
_____	_____	Multiple Channels (braiding or anabranching)
_____	_____	Large Gravel Bars
_____	_____	Young Disturbance Vegetation
_____	_____	Eroding Banks
_____	_____	High Sinuosity
_____	_____	Wood Jams

If “yes” to 1 or more channel features, channel migration is likely to be occurring. Proceed to Part 2.2 Field Evaluation to Determine Channel Migration.

If none of these channel features are evident on the aerial photographs, proceed to Field Evaluation to Determine Channel Migration to confirm that no channel migration has historically occurred.

*Observations of Channel Migration from Photos and Maps:* For larger rivers, active channel migration is often readily observed on a single aerial photograph or by comparing aerial photographs and maps. Where channel migration is apparent, proceed directly from the Office Review Form to Part 2.3 Delineating the Channel Migration Zone.

A lack of channel movement visible on aerial photographs does not mean that channel migration has not occurred. In particular, photos may be of limited value in observing the movement of small streams. If channel migration is not observed in the aerial photographs and topographic maps, proceed to Part 2. Field Evaluation to Determine Channel Migration for final determination.

*Determining Valley Confinement from Photos and Maps:* Valley width is the area within the comparatively flat valley bottom, measured from the edges of significant changes in topography (typically the base of hills or mountains). In migrating channels, the valleys must be wide enough to accommodate lateral movement of the stream. The Forests and Fish Report (WSDNR et al., 1999) identifies streams potentially associated with a CMZ as those that are moderately confined or unconfined.

Aerial photographs may be useful to estimate valley confinement. However, aerial photographs must be viewed in stereo, otherwise the features of interest may not be apparent. From the photos:

1. Identify valley walls where hillslopes or other significant topographic controls begin. Measure the average valley width along the segment;
2. Identify the width of the active stream channel (this includes areas currently under water, adjacent unvegetated areas, and vegetated islands). Measure the average channel width along the segment; and
3. Determine the ratio of average valley width to average channel width (i.e., approximately less than 2 times valley width or greater than 2 times valley width).

Topographic maps can also be used to estimate valley confinement:

1. Measure the average valley width between the contour lines that define the valley walls. The contour lines of the valley bottom will be broadly spaced, and those of the adjacent hillslopes will be more closely spaced (Figure 3);
2. Observe how sharply angled the contour lines surrounding the channel are. Valleys that are tightly confined will have closely spaced contour lines that form a narrow upstream-pointing V-shape (see the stream labeled “Creek” in Figure 3). Unconfined valleys will have more widely spaced contours that form an open V- or U-shape (Figure 3);
3. Estimate the average channel width from aerial photographs or field knowledge; and
4. Determine the ratio of average valley width to average channel width (i.e., approximately less than 2 times valley width or greater than 2 times valley width).

It can be difficult to measure channel confinement from standard 7.5 minute topographic quadrangle maps (1:24,000 scale), especially for small channels because the channel widths are difficult to discern. Wherever possible, stream channel confinement estimated from topographic maps should be confirmed with aerial photographs and field observations. Where available, high-



resolution topography from photogrammetry, Light Distancing And Ranging (LiDAR), and land surveys can be extremely useful in identifying channel features.

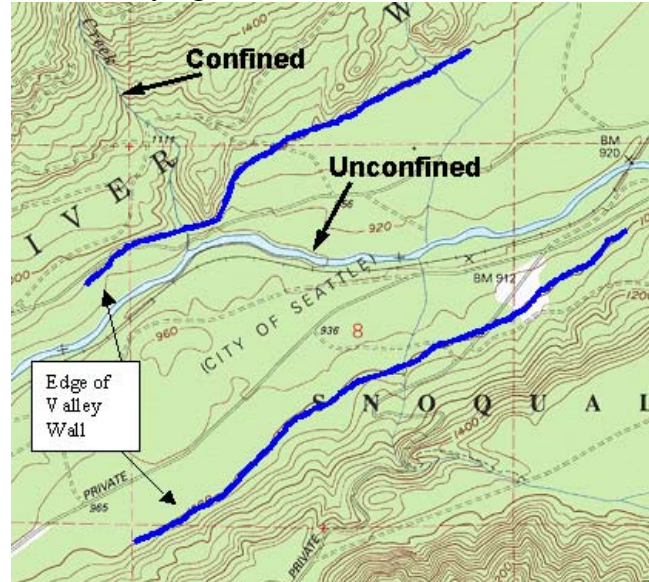


Figure 3. Valley confinement using a topographic map.

*Aerial Photograph Observations of Channel and Floodplain Features:* The following figures are examples of aerial photographs and a map that display one or more of the channel and floodplain features listed on the Office Review Form.



Figure 4. Channel and floodplain features (floodplain feature codes listed below).

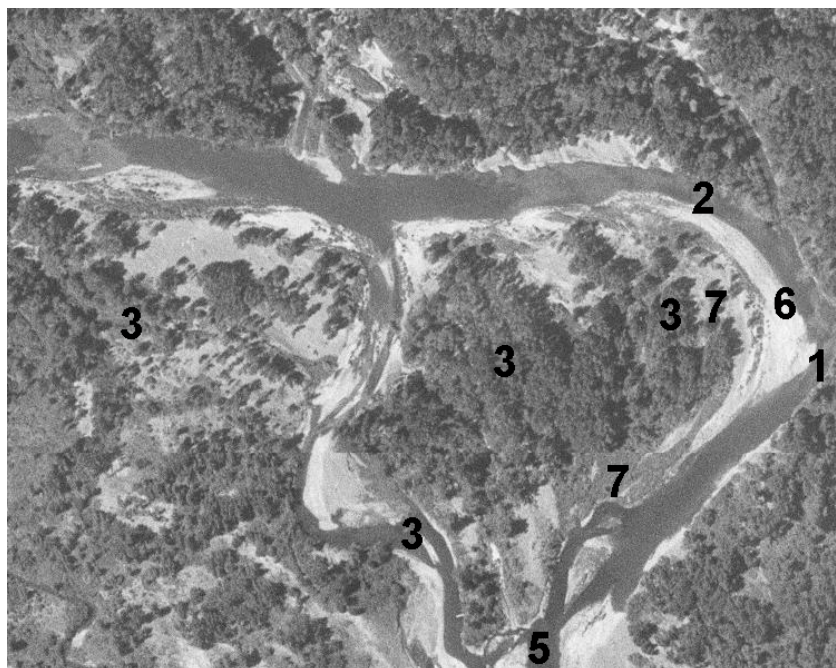
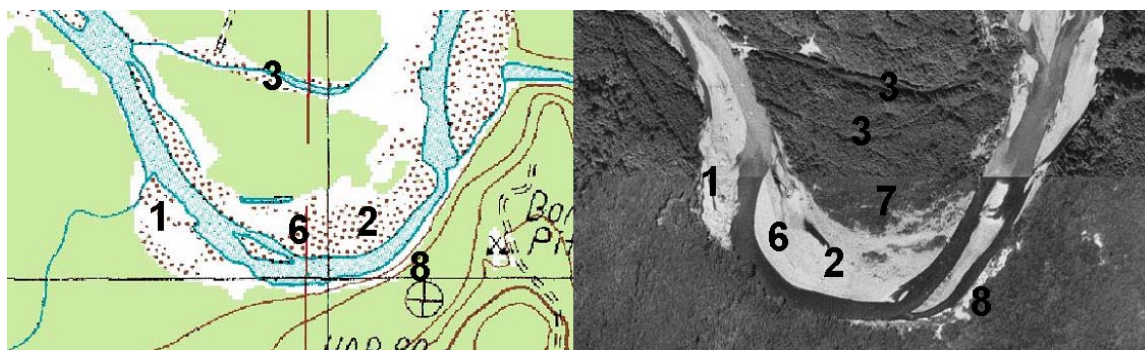


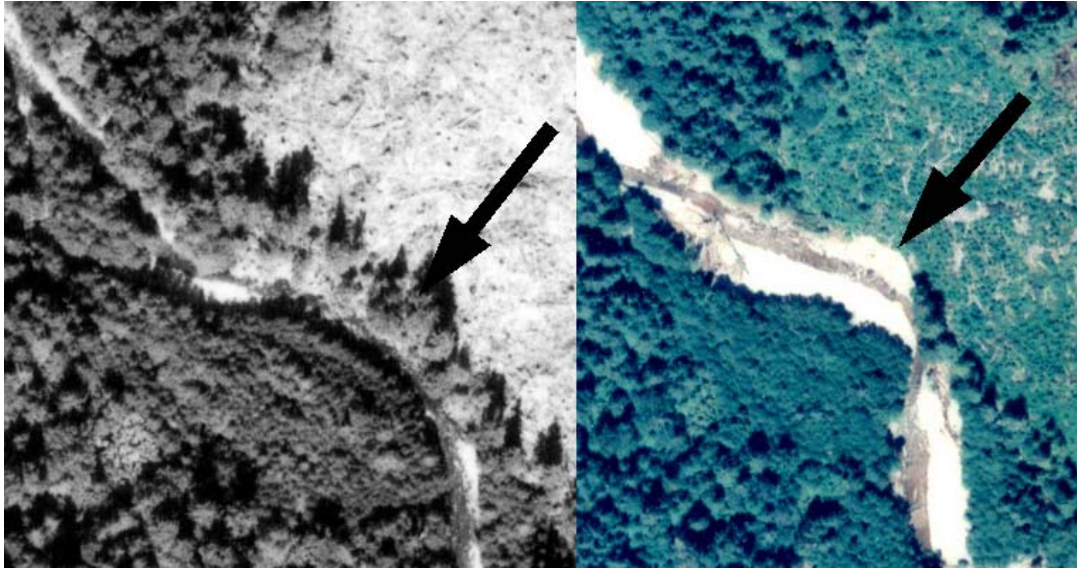
Figure 5. Channel and floodplain features (floodplain feature codes listed below).



Figures 6a and 6b. Channel and floodplain features (floodplain feature codes listed below).

Figures 4, 5, 6a, and 6b. Examples of channel and floodplain features: 1) obvious channel movement; 2) high sinuosity; 3) secondary channels; 4) braiding; 5) anabranching (multiple channels around vegetated islands); 6) large gravel bars; 7) young disturbance vegetation; 8) eroding bank.

*Aerial Photographs Observations of Bank Erosion:* Observable lateral movement of the channel may be due to avulsion or erosion processes. Avulsion is likely to involve floodplain surfaces, where erosion may involve higher floodplain and terrace edges. It may be possible to distinguish between these processes from examination of aerial photographs. An avulsion may isolate a portion of the floodplain between channels, whereas bank erosion will not. The exposed soils (scarp) of the eroding bank may also be observable in the photos. Bank erosion can be episodic and strongly correlated with flood frequency, so care must be taken to evaluate a sufficiently long period of time to determine if significant bank retreat is occurring within the segment. The office analysis time frame should include the entire length of the aerial photograph record and/or cover at least two decades to account for impacts of larger events (Figure 7a and 7b).



*Figures 7a and 7b. Bank erosion between two sets of aerial photographs.*

## 2. Field Evaluation to Determine Channel Migration

The purpose of the field evaluation is to use field observations to determine if historical channel migration has occurred and, therefore, if a CMZ delineation is necessary. This is accomplished by working through observations of evidence in the Field Evaluation Table below. Evidence identified on the Field Evaluation Table is described in detail following the table.

When field evidence indicates channel migration to be occurring, proceed to Part 2.3 Delineating the Channel Migration Zone. If no evidence of historical channel migration is found, then establish a RMZ from the bankfull edge of the stream (see Part 1. Determining Bankfull Width). When experienced with the Field Evaluation Table, a field practitioner may find the Flow Chart for Determining Channel Migration to be a useful field tool.

To conduct a field reconnaissance for evidence of channel movement, the entire floodplain within or adjacent to the project and, as necessary, some distance beyond the area of the forest practice should be walked to observe the character of the channel. Evidence of channel migration should be obtained from a homogenous channel segment. To establish a homogenous channel segment, follow the guidance outlined in Part 2.3. Note that permission of adjacent landowners to access their property may be required.

## Field Evaluation Form

Evidence Category	Observations	Next Step
Valley Confinement	C1 The width of the valley floor is less than 2 times bankfull width of the channel.	No CMZ; delineate RMZ from bankfull edge.
	C2 The width of the valley floor is equal to or greater than 2 times the bankfull width of the channel.	CMZ may be present; continue to lateral activity category.
Lateral Activity	L1 No lateral movement possible due to presence of bedrock bed and banks or other erosion-resistant material.	No CMZ; delineate RMZ from bankfull edge.
	L2 There is obvious lateral movement of the channel.	Proceed to delineating the CMZ.
	L3 Neither L1 nor L2 is true.	Continue to vegetation category.
Vegetation	V1 Along a representative channel, old growth conifer trees or stumps occur uninterrupted from higher terraces or valley walls down to both stream edges and there are no secondary channels.	No CMZ; delineate RMZ from bankfull edge.
	V2 There are age-progressive bands of trees or other linear vegetative features of channel migration on the floodplain.	The channel is migrating or has historically migrated. Proceed to delineating the CMZ.
	V3 There is no vegetative evidence of channel migration (except, perhaps, interrupted old growth trees or stumps).	Continue to secondary channels category.
Secondary Channels	S1 There are no secondary channels.	No CMZ. Delineate RMZ from bankfull edge.
	S2 There are secondary channels on the floodplain and all bed elevations lie above the bankfull elevation of the main channel.	Historical channel migration may have occurred but was not identified by this evaluation. Proceed to Part 2.3 Delineation of the Historical Migration Zone (HMZ) for further evaluation.
	S3 There is at least one secondary channel on the floodplain with bed elevation at or below bankfull elevation.	The channel is migrating; proceed to delineating the CMZ.

*Valley Confinement (Field Evaluation Form C1-C2):* Measuring valley confinement is the first step in determining if CMZ delineation is necessary. Measuring valley confinement in the field is accomplished by measuring the width of the entire valley floor from hillslope to hillslope and comparing this value with the bankfull width of the stream. When characterizing the average bankfull width and average valley width for the channel segment, take enough measurements to provide an accurate representation of valley confinement. Where valley confinement is not obviously discernible, bankfull width and valley width should be measured and averaged from at least 10 evenly spaced cross section transects along the channel segment.

If valley width is less than 2 times bankfull width, on average (C1), it is not necessary to delineate a CMZ. If valley width is approximately equal to or exceeds 2 times bankfull width, on average (C2), continue the evaluation (Figures 8 and 9).



*Figures 8 and 9. Confined valley and an unconfined valley.*

Before proceeding with the rest of the field evaluation, review the definitions of “terrace” and “floodplain”. These terms are defined to help with distinguishing between terraces and the floodplain surfaces where most of the field evidence for historical channel migration will be found.

“*Terrace*,” as defined here, is a former or relict floodplain no longer inundated by floodwater given the current climate. A non-floodable terrace surface is not considered to have the potential to be re-occupied by the river or stream under the current climate regime and natural wood loads; however, it could be susceptible to erosion by the stream. Some care must be taken when identifying surfaces as terraces because any land-use or management-induced loss of large woody debris may have resulted in the channel incising into its floodplain, temporarily stranding surfaces that are floodplain surfaces during times of natural wood loads.

Evidence of a terrace surface include, but are not limited to:

- No evidence of inundation by floodwaters
  - No evidence of fine sediment deposition on the surface or embedded in tree bark or moss;
  - No flotsam hanging in the brush;
  - No stick or log jams on the surface; and
  - No evidence of flowing water on the surface, such as scour features, flattened grass or secondary channels formed by scour action of the modern river.
- There is soil development (presence of a deep A-Horizon or humus organic layer).
- There are noticeable differences in the geologic materials as compared with lower surfaces (e.g., glacial deposits versus Holocene alluvium).
- Vegetation on the surface is dominated by upland plant species, except where there are perched wetlands.
- The surface lies ABOVE the elevation of the 100-year flood inundation. Usually, this can be reasonably agreed to, taking into account evidence of incision and wood loss. It should be a rare situation where this elevation needs to be quantified.

“*Floodplain*,” as defined here, is the area of the valley that can flood given the current climate and natural loads of large woody debris (LWD). The floodplain may contain surfaces at one or many elevations. The floodplain is the area to be evaluated for possible inclusion within the CMZ.

Evidence for a floodplain includes, but is not limited to:

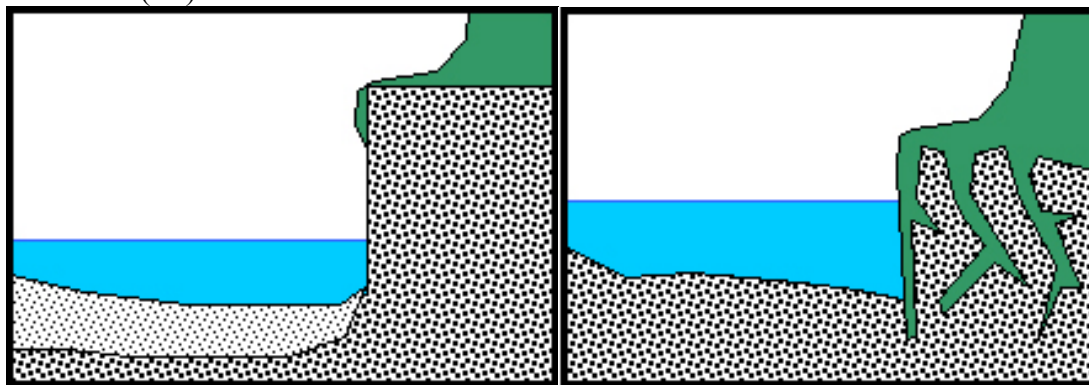
- Flotsam hanging in the brush and log jams on top of the surface.
- Fine sediments are found in the tree moss and there may be abrasions of the lower tree trunks.
- Silt, sand, or gravel are found immediately under the leaf layer.
- The alluvial materials consisting of silt, sand and gravel are uncompacted and unconsolidated.
- A wetter understory plant community with facultative wet and/or wetland obligate species is present. Disturbance species such as willow, cottonwood and alder are likely to be present in the overstory canopy.
- Evidence of flowing water, such as scour features, flattened grass or secondary channels formed by scour action of the modern river.
- The elevation of the surface lies near the elevation of the highest channel features (e.g., log jams and gravel bar surfaces).
- The surface lies WITHIN the elevation of the 100-year flood inundation. Usually, this can be reasonably agreed to, taking into account evidence of incision and wood loss. It should be a rare situation where this elevation needs to be quantified.

If some period of time has lapsed since a large flood event greater than a 20-year event, evidence that relates directly to flooding of a surface may be muted.

*Lateral Activity (Field Evaluation Form L1-L3):* This category of field evidence is a screen for obvious indicators of lateral channel activity by identifying conditions where channel migration is unlikely and those where channel movement is apparent. Where neither condition described as field evaluation form question L1 or L2 below are true or obvious, proceed with the evaluation (L3) and the vegetative indicators category below.

If the bed and banks of the stream are composed of bedrock or other erosion-resistant material, no lateral movement of the channel is possible (L1), and the RMZ will begin at the bankfull channel edge. Stream banks resistant to erosion are composed of materials such as hard rock or well-cemented alluvial deposits that can form stable vertical banks. These do not experience significant erosion (Figure 10). Cemented alluvial deposits often look similar to unconsolidated and erodible alluvial deposits, but display their resistance to erosion by showing resistance to removal of individual stones by hand and exhibit a non-retreating near-vertical bank (Figure 10). On these banks, tree roots are unlikely to be exposed but may “wrap” around the edge of the bank. Under-cutting of stream banks consisting of cohesive materials such as clay, or partially cemented or well-consolidated deposits may indicate relative stability or very slow erosion.

Stream banks that are re-enforced with tree roots can be quite stable if the roots extend the full height of the bank and are not destabilized by undercutting from the stream channel (Figure 11). This occurs along relatively small channels and where bank materials have some natural erosion resistance (L3).

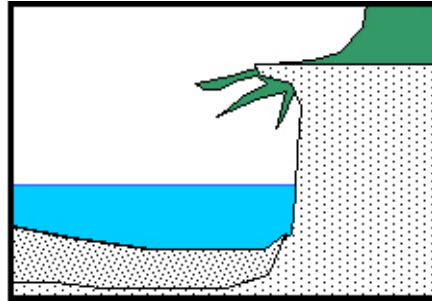


*Figure 10. Erosion-resistant bank.*

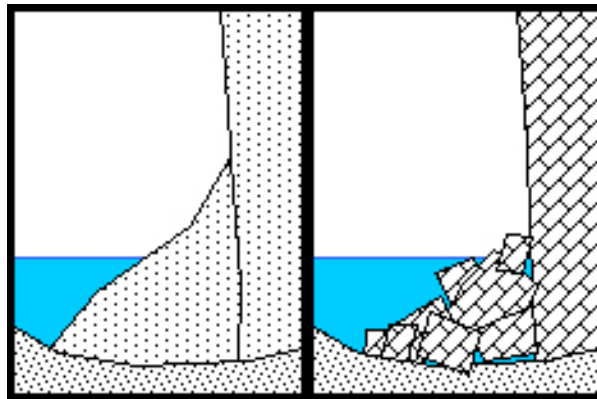
*Figure 11. Root-stabilized bank.*

Where it is obvious the channel is or has been moving laterally, proceed to delineating the CMZ (L2). Abandoned channels and extensive bank erosion are some obvious indicators. Stream banks susceptible to erosion are usually composed of the same size material currently being transported by the channel, as evidenced in the channel bed and bars. Eroding stream banks can be identified through the observation of frequent overhanging tree roots exposed in the bank above the stream channel, an indication that the bank has retreated a distance equal to the length of root exposure (Figure 12). The eroding bank is typically paired with a bar deposited on the opposite bank or downstream. Fan-like accumulations of the same material that the bank is composed of at the base of the slope can also indicate that the stream channel has eroded into the slope (Figure 13a). These accumulations are typically found in stream banks made of unconsolidated alluvium (sand, gravel, cobble), but can include more consolidated materials (clay, compacted or partially cemented silt or gravel) that accumulate in blocks at the toe (Figure

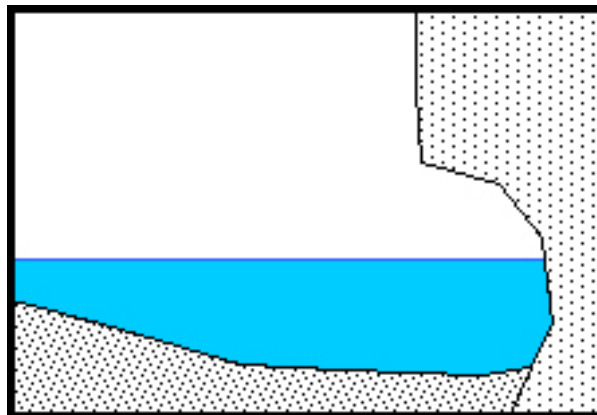
13b). A stream bank where the toes have been undercut can also indicate active bank erosion, particularly if bank failures are also observed along banks of similar material within the same stream channel segment (Figure 14). All these situations fall under question L2 on the Field Evaluation Form. If it's unclear from field evidence that bank erosion indicates obvious lateral movement, continue with the evaluation starting from question L3.



*Figure 12. Root exposure as an indication of bank erosion.*



*Figure 13a. and Figure 13b. Accumulation of eroded material (Figure 13a) and blocks of material (Figure 13b) at base of bank.*



*Figure 14. Undercut stream bank.*



*Vegetative Indicators of Channel Migration (Field Evaluation Form V1-V3):* Existing vegetation and historic vegetative features that are still present can provide significant indications of channel history within a given stream reach. Vegetation age is a reflection of the length of time that has passed since disturbance. Vegetation type or plant community can also reflect the type or severity of disturbance that has occurred. When used in conjunction with other channel indicators, vegetation patterns can greatly assist in the identification and delineation of channel migration zones, but are never sufficient evidence alone (i.e., the presence of old trees or stumps is not sufficient evidence to exclude an area from a CMZ).

Much of the land subject to forest practices regulation has been logged at least once. Often old-growth stumps and sometimes trees remain, bearing evidence of pre-settlement stand conditions. Old growth Douglas-fir and Western red cedar stumps are especially persistent within the forested environment. Surfaces that are covered with old-growth trees or stumps have not been disturbed by river influences within the time period reflecting the age of the trees or stumps. In general, stream-adjacent surfaces populated with persistent old-growth trees or stumps from valley wall to bankfull edge, uninterrupted by secondary channels, are considered to be upland terraces or stable floodplain. These surfaces are typically outside the influence of channel migration (V1) if they are not subject to channel migration through erosion or avulsion processes (L2). Where surfaces with old growth trees or stumps contain linear channel features without stumps or trees of the same age, proceed with the evaluation (V3) if there are no other vegetative indicators as described below (V2).

Patterns of vegetation can indicate areas disturbed by past channel activities (V2). Vegetation types often show up in linear patterns on a stream-adjacent surface. Age-progressive bands of vegetation along a stream reach can indicate meander migration that occurs as an active channel moves laterally away from a stream bank over time (Figures 5 and 6). Tree species such as alder can colonize natural linear features such as secondary channels or other deposition/disturbance edges on the floodplain. Caution must be used in this interpretation however, as vegetative bands can also represent non-stream influences such as orphaned road grades, skid trails, or gravel extraction sites.

A stream-adjacent wetland plant community such as red alder with a sedge understory may denote a low floodplain surface subject to frequent inundation (V2). A red alder/sword fern plant community indicates a drier site such as a re-colonized gravel bar, debris fan, or even an upland terrace. Surfaces with this vegetation can still flood, and their presence is inconclusive. Stream bank or terrace edges that have had sufficient time post-disturbance to develop a stable angle of repose are typically covered with timber and/or understory vegetation (V3). Non-bedrock channel features that are devoid of vegetation have been subjected to recent or recurrent scour/deposition (V2). If it's unclear from field evidence that vegetation patterns indicate channel migration, assume there is no vegetative evidence of channel migration and continue with the evaluation starting from question V3.

*Secondary Channels (Field Evaluation Form S1-S3):* Floodplain river systems often have multiple types of interacting *channels*, which aid in floodplain building processes and the conveyance of water longitudinally and laterally. Secondary channels carry water (intermittently

or perennially in time; continuously or interrupted in space) away from, away from and back into, or along the main channel. *Anabran* channels are the most common form of secondary channel, which are a diverging branch of the main channel that re-enters the main channel some distance downstream. Secondary and anabran channels can be subdivided into: side channels, wall-based channels, distributary channels, abandoned channels, chutes, and swales (Part 2.5 Technical Background, Floodplain-building Processes and Part 2.7 Glossary).

Presence of secondary channels on floodplain surfaces can convey much information to the field practitioner regarding channel processes and the potential for channel migration through lateral erosion or avulsion processes. Active secondary channels (e.g., side channels or overflow channels) are obvious locations where the active floodplain network has flowed in the recent past. Over time, these channels may be enhanced by the river system through:

- Active enlargement of channel dimensions (i.e., width or depth) through increasing vertical and lateral connectivity with the main channel; and
- Total occupation of the river in that location through avulsion (second- and third-order avulsion).

Secondary channels can also be slowly or abruptly abandoned by the active channel when:

- The main channel migrates away from the channel area;
- The channel becomes cut off at its upstream end due to wood or sediment deposition;
- The channel fills in with sediment or organic material from in-channel aggradation and/or overbank floodplain deposition of sediment (silts and sands); and
- The main channel incises into floodplain deposits resulting in reduced connectivity with the secondary channel.

Thus, secondary channels can be episodically activated and deactivated, either partially or fully through time. Over time, secondary channels can become less defined due to infilling and vegetation growth, which masks their surface distinction and the interpretation of their previous fluvial processes. In certain situations, secondary channels may also stay static in their form and processes. A static secondary channel is rare in Washington state where discharge of water, sediment and wood is often highly variable through time, creating dynamic channel evolution processes.

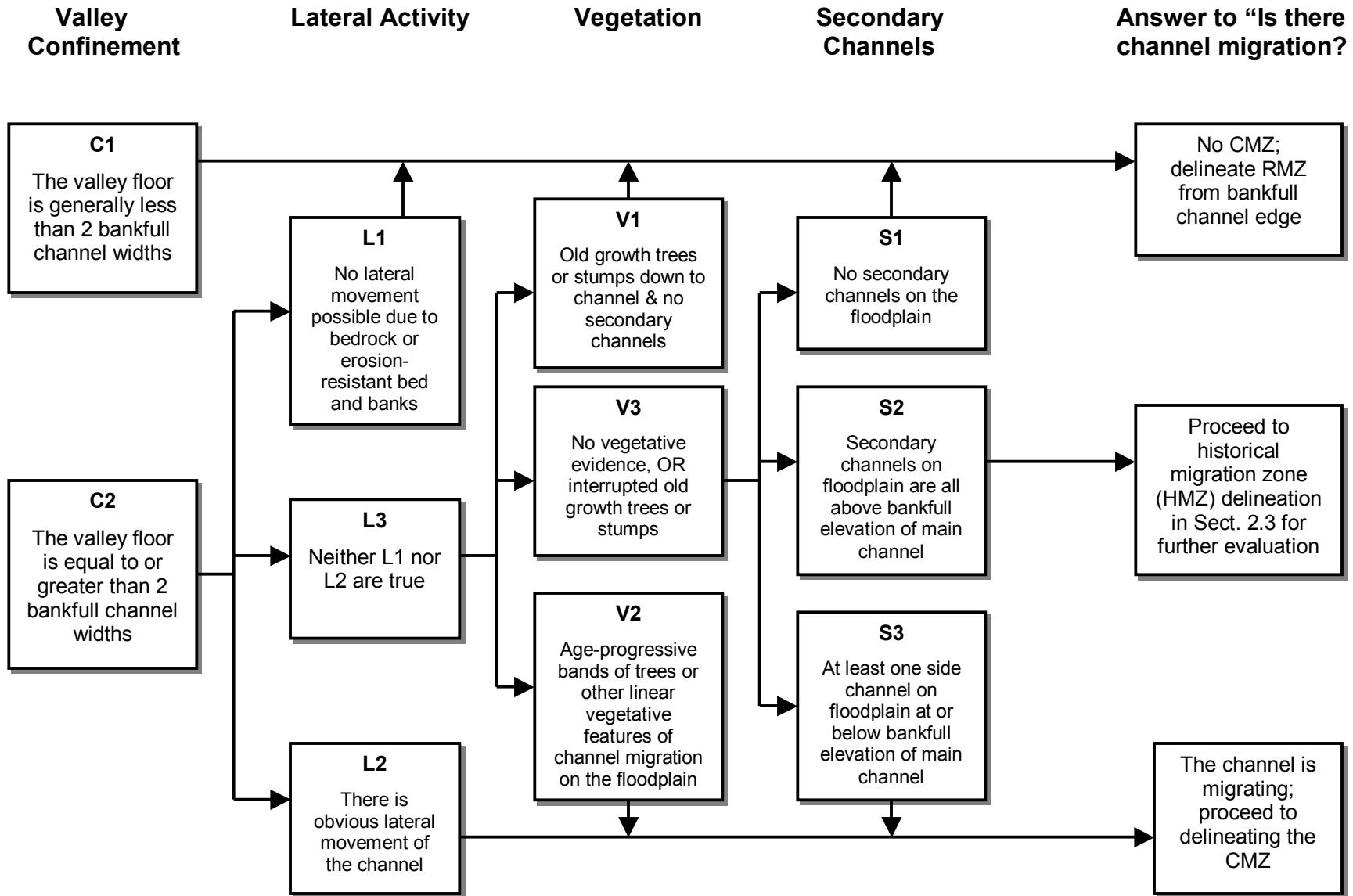
The presence of secondary channels does not alone predict the likelihood of future channel migration, nor does the absence of secondary channels on the floodplain solely indicate that channel migration by avulsion is unlikely. These features need to be assessed individually and in conjunction with other floodplain forms and processes along the segment of interest.

If there are no secondary channels of any sort on the floodplain, channel migration is unlikely. This would mean that there are no other indicators of channel migration described under the L2 or V2 evidence above. Proceed to delineating the RMZ from the bankfull edge (S1).

The channel is migrating if there are any side channels on the floodplain where the bottom of the channel is at or below the bankfull elevation of the main channel, proceed to delineating the CMZ (S3).

If there are secondary channels on the floodplain and all bed elevations of these channels lie above the bankfull elevation of the main channel, then channel migration may have occurred but cannot be determined without further evaluation. Proceed to Part 2.3 and the delineation of the historical migration zone (HMZ) for guidelines to further evaluate if historic channel migration has occurred (S2).

Flow Chart for Determining Channel Migration



### 2.3 Delineating the Channel Migration Zone

Once it has been determined that channel migration has historically occurred or is occurring anywhere along the channel segment that includes the proposed forest practice activity, the landowner is required to begin the RMZ at the outer edge of the channel migration zone. In addition, if the evidence for historical migration remained unclear after following the guidelines outlined in Part 2.2, the field practitioner is instructed to use the lines of evidence for delineating the Historical Migration Zone (described below) to determine whether or not a CMZ is present. It is therefore possible to work through the delineation methods and determine that historical channel migration has not occurred and CMZ delineation is not necessary.

The following guidelines and delineation scenarios contain technical recommendations for CMZ delineation. It may be reasonable to deviate from these recommendations based on carefully developed technical analysis of the historical channel and watershed processes that control channel migration. Consulting with the DNR forest practices forester or conducting additional analysis is encouraged whenever or wherever you are confused about how to proceed with the delineation of a CMZ.

Information useful to accompany the forest practices application (FPA) includes a statement describing the lines of evidence used to establish the delineation along with any analyses performed or reports generated (see CMZ Reporting Form).

*Methods Overview:* The following methods have been developed to guide CMZ delineation. The general methodology in this section defines the CMZ based on valley and floodplain features and channel processes. The outer edge of the CMZ is identified using historical map and photo analysis and/or current field evidence to predict future channel migration.

It is helpful to view the river landscape as a series of the following identifiable components that can be used collectively to define the boundaries of the CMZ (Figure 15). All zones are not necessarily present along all river segments.

1. The historical migration zone (HMZ) – The sum of all active channels over the historical period (post 1900).
2. The avulsion hazard zone (AHZ) – The area not included in the HMZ where the channel is prone to move by avulsion and if not protected would result in a potential near-term loss of riparian function and associated habitat adjacent to the stream.
3. The erosion hazard area (EHA) – The area not included in the HMZ where bank erosion from stream flow can result in a potential near-term loss of riparian function and associated habitat adjacent to the stream.
4. The disconnected migration area (DMA) – The portion of the CMZ behind a permanently maintained dike or levee.

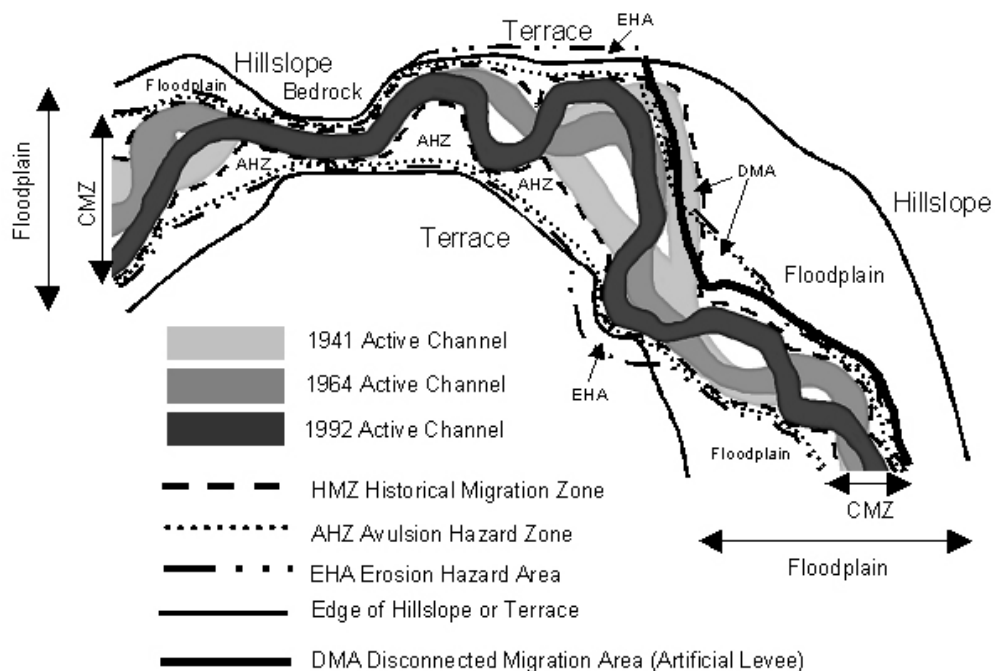


Figure 15. Valley and floodplain features identified and evaluated for inclusion into the CMZ delineation. All zones are not necessarily present along all river segments.

The concept of looking at the channel migration zone as a collection of these components was adapted from Rapp and Abbe, 2003. All river segments with a CMZ necessarily have an HMZ; additionally, some segments have AHZ, EHA and/or DMA.

The remainder of this section presents information on channel segment delineation, delineation of the three major components of the CMZ, and identification of floodplain features outside of the CMZ. Different types or “scenarios” of channel migration situations have also been provided to facilitate CMZ delineation and illustrate the use of appropriate evidence and methods.

In delineating a CMZ, we attempt to anticipate the type and scale of large channel-changing events that may occur such as 25, 50, and 100-year flood events – the scale of events for which we have some predictive capability. Careful evaluation of field evidence will help the landowner determine the limit of channel migration over the near-term future. An understanding of general river processes may also be helpful to the landowner. To this end, technical background (Part 2.5) is included, and users of this manual are encouraged to become familiar with the concepts offered.

Future river channel changes (e.g., channel aggradation, altered LWD load, and channel avulsion) may bring improved understanding of local stream processes. When these changes occur, existing CMZ boundaries can be re-evaluated in the context of an entire stream segment, and the additional information gained can be applied to future forest practices. However, a lack of channel changes within a few decades after the initial delineation does not preclude the potential for channel migration in response to larger flood events or other significant watershed

changes in the future. If the nature of river form and processes is well understood during the initial CMZ delineation, future adjustments to the CMZ should be minimal.

*Segment-Level Delineation:* The lateral extent of the channel migration zone is based on field evidence found at the channel segment scale. Although many CMZ delineations will be specific to those portions of the stream adjacent to individual forest practices activities, some or perhaps much of the evidence for the delineation may exist on the opposite bank or elsewhere in the associated channel segment. Similar to its use in watershed analysis, stream segments are lengths of stream that have similar valley confinement, discharge, channel pattern, and average valley gradient (Figure 16). Segments may vary from a few hundred feet to a couple of miles in length, and are somewhat scale-dependent such that smaller streams may have shorter segments.

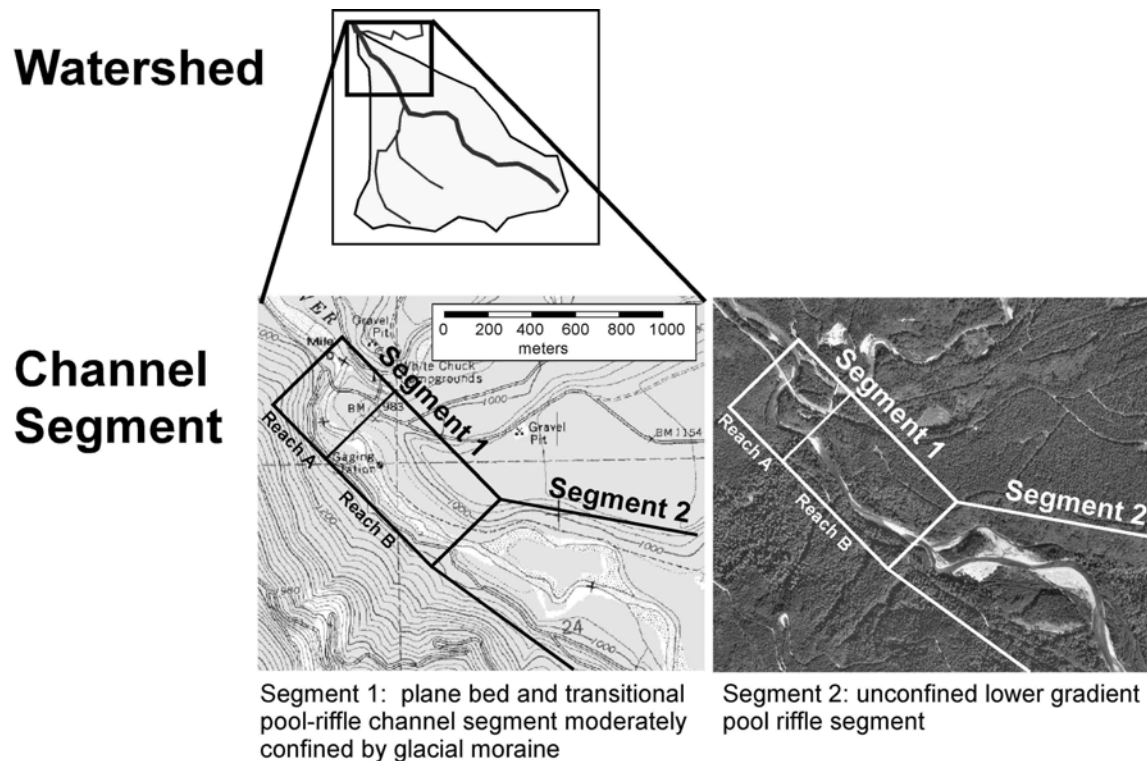


Figure 16. Channel hierarchy from watershed to segment to reach scale.

### Identifying Segment Breaks

Stream segments are most easily identified initially from topographic maps and aerial photographs, and then field verified. Segment breaks are determined from abrupt or gradual changes in confinement, gradient, channel pattern, streamflow, or other channel or watershed characteristics as listed below:

- Confinement: A change in the valley confinement (i.e., the ratio of bankfull width ( $w_b$ ) and valley width ( $w_v$ )), approximately corresponds to one of three confinement classes from a wide floodplain to a confined canyon.

<u>Confinement class</u>	<u>Floodplain width</u>
Unconfined	$w_v > 4 w_b$
Moderately confined	$2 w_b < w_v < 4 w_b$
Confined	$w_v < 2 w_b$

- Gradient: A significant change in average channel gradient, corresponding to one of the following gradient classes:  
0-0.9 %    1.0-1.9 %    2.0-3.9 %    4.0-8.0 %    8.0-20 %
- Channel pattern changes (e.g., from a straight to sinuous to braided channel, or a single-thread to anabranching channel)
- Tributary confluences, which can result in:
  - Significant streamflow discharge changes
  - Significant channel width and/or depth changes
  - Significant changes in the type and/or quantity of sediment.
- Streambed or streambank material changes (e.g., bedrock to gravel bed, cohesive to non-cohesive banks).

Advantages to delineating a CMZ for one or more segment lengths rather than a single forest practices application are:

1. At the broader scale, it is easier and more defensible to define segments of varying activity from no migration to small-scale migration to very active migration. In some large river systems, segments of active migration and those of little or no migration may alternate down the length of the river. Careful analysis of the aerial photo record and the field evidence for migration will help define these segments. Observations may lead to hypotheses about the subtle controls causing these changes. It may be difficult to defend the delineation of just two segments, one with no or only small-scale migration and one with very active migration, but this distinction may be quite defensible when alternating segments of different behaviors have been documented. Large-scale analysis of channel migration is most strongly recommended for large rivers.
2. Multiple segment analyses provide a higher level of confidence in channel migration delineation because more is understood about the river's migration behavior.
3. There may be significant cost savings in conducting a large-scale analysis. Cost savings are likely to be very significant if landowners and other cooperators conduct these analyses together.



*Channel Migration Zone Components:* The CMZ, as defined by forest practice rules, may or may not include all portions of the floodplain. Some floodplain surfaces may be periodically inundated, but lack the risk factors for channel shifting or bank erosion. The following terms are defined and described below for those areas included in the CMZ.

A “surface” of a floodplain is a widely used but poorly defined concept. Conceptually, a “surface” is a constant feature up and down the valley. It lies at a consistent elevation above bankfull. A discrete process at a discrete point in time has formed the surface, resulting in consistent soil development and other age indicators. Unfortunately, these conceptual “surfaces” rarely exist because processes that form floodplain surfaces are complex and often localized. Where contiguous surfaces were formed, they have often been fragmented by erosion and avulsion. Therefore, a “*surface*” is specifically defined as those individual pieces of the floodplain that share the following characteristics:

- The surface lies at a fairly consistent relationship to the bankfull channel elevation, understanding that the relationship between a given surface and bankfull elevation can vary within a segment due to irregularities on the surface and due to local flow patterns and obstructions.
- The surface displays evidence that supports fairly constant flood frequency.
- The surface supports a fairly similar plant community as influenced by water table or flooding (perched wetlands should not be included in this consideration).

It is assumed that a common process as defined above has formed the fragments of a surface.

*Historic Migration Zone (HMZ):* The historic migration zone (HMZ) is the sum of all active channels over the historical period, and is delineated by the outermost extent of channel locations over that time (Figure 15). This is direct evidence of where the channel has been and may be assumed to reoccupy. The historical period usually includes the time between the year 1900 and the present – the approximate time period sufficient to capture pre-timber harvest channel conditions. This time period is extended for those sites known to have been impacted by timber harvest activities prior to 1900, or where historical information such as Government Land Office maps and notes are available at <http://riverhistory.ess.washington.edu/> (Puget Sound Rivers) and <http://pnptc.org/t-sheets.htm> (Olympic Peninsula Rivers). At a minimum, the CMZ will include the HMZ except where a portion of the HMZ is behind a permanently maintained dike or levee (see Disconnected Migration Area).

The HMZ is identified based on photos, maps, and field evidence (Figure 17). Since few streams have a complete historical map and photo record or the stream may be too small to be adequately assessed from photos or maps, what historical data is available is supplemented with field evidence. When in doubt whether a surface is part of the historic migration zone, evaluate for avulsion hazard potential.

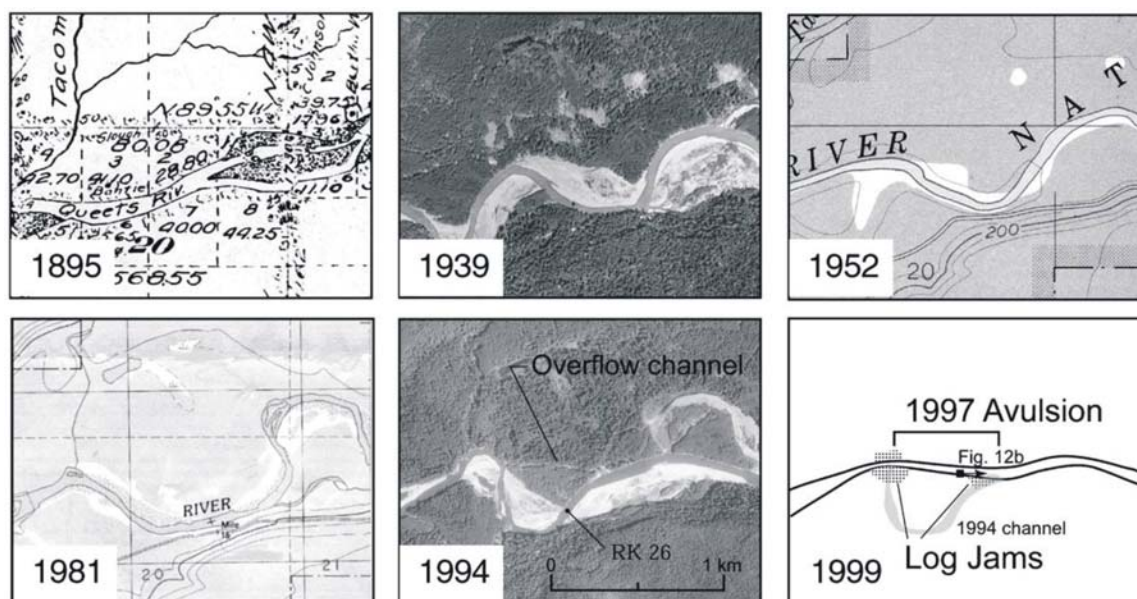


Figure 17. A sequence of historical channel maps and photos: 1895 General Land Office Survey; 1939 USGS aerial photograph; 1952 15' USGS topographic quadrangle map; 1981 7 1/2' USGS topographic quadrangle map; 1994 DNR orthophoto; and a field map (modified from O'Connor et al., 2003).

In determining the historic migration zone first, include the area within the active channel and any side channels. Then, if available for the segment, analyze the historic map or aerial photograph record to determine the areas the channel has occupied in the past. Next, examine the floodplain surface(s) for channels abandoned within the historic time frame that may not be evident on the historic map or aerial photograph record. Evidence of historic abandonment may include: lack of stumps; surficial deposits of gravel or cobble, which can be thinly covered by fine, overbank sediments or duff; plant communities that are younger than the surrounding floodplain surface; and surficial evidence of logjams. Finally, examine the surface(s) for age-progressive plant communities that indicate point bar growth during the historic time period.

Evaluating the lines of evidence during the delineation of multiple-surface floodplains requires some understanding of the recent flood history of the river. The longer the period of time since the last disturbance event, the more muted the surficial evidence for channel migration will be. In particular, evidence of bed scour may be covered in leaf litter and humus. Some coring or digging in low or topographic depressions to determine the nature and age of shallow materials may be useful.

Strong field evidence of historic channel migration on a seemingly higher elevation surface may suggest a historic change in wood and/or sediment loading or channel processes that have caused the channel to downcut, and this condition can be confirmed through historical information or analysis. The reintroduction of mature wood to the stream could bring the bed elevation up to that surface in the future.

Smaller and moderately confined segments of a stream are generally closer to sediment sources and may receive large pulses of sediment that are stored for shorter time frames than sediment in

large floodplains further downstream. Because these segments may aggrade and degrade rapidly, the resulting deposits may be at an anomalously high elevation above the current channel. Because these surfaces were deposited and abandoned rapidly, they may also lack any surface expression of former channel features. Additional evidence includes the buried stems of trees (no obvious root collar on the tree) on surfaces where tree age may otherwise indicate an older surface. Many hardwoods will tend to survive root collar burial, whereas conifers will not. Buried stems of trees (no obvious rootwad) may indicate an older surface. Much of the other evidence for the HMZ will apply in these locations, even though the surface may not flood, given the current elevation of the channel.

**Avulsion Hazard Zone (AHZ):** Channel *avulsions* are defined as relatively sudden and major shifts in the position of the channel to a new part of the floodplain (first-order avulsion) or sudden reoccupation of an old channel on the floodplain (second-order avulsion) (Nanson and Knighton 1996) (Figure 40 and Part 2.5). Avulsions into floodplain deposits can occur at a variety of scales and channel sizes. Primary avulsion paths can be guided by log jams or the presence of poorly defined topographic low points along the floodplain, and secondary avulsion paths can follow better defined *secondary* or *abandoned channels* on the floodplain.

The avulsion hazard zone is the area not included in the HMZ where the active channel of a stream is prone to move to (Figures 18a and 18b) and if not protected would result in a potential near-term loss of riparian function and associated habitat adjacent to the stream. The purpose of delineating avulsion hazard zones is to anticipate future shifts in channel location outside the recent historical locations. Predicting channel shifting to a new portion of the floodplain (first-order avulsion) is more challenging than predicting reoccupation of an old channel (second-order avulsion). The time frame for migrating channels to move across their floodplains varies from decades to hundreds of years; therefore, in some river systems, much older floodplain surfaces may still be subject to avulsion. The evidence and situations outlined below will help identify these floodplain areas at risk.



Figures 18a and 18b. Channel avulsion that occurred between two photo years.

The evidence for the avulsion hazard zone includes consideration of several situations:

1. Those floodplain surfaces extending outward from the HMZ that are of similar height to the surfaces within the HMZ, including:
  - If a surface has experienced historical avulsion within the segment, that entire surface is within the AHZ.
  - Floodplain islands stranded by historical channel avulsion.

- The surface within the elevation of the highest channel features (gravel bars, the bulk of wood jams, mid-channel surfaces).
  - A surface beyond a flood berm that is at or below bankfull elevation.
2. There may be additional situations where the near-term risk for avulsion is significant. The relationship of a portion of the floodplain, often a meander bend, to the active channel may generate preferential avulsion paths. The possibility of such an avulsion path can be assessed in the context of knowledge of local channel behavior, knowledge of watershed condition and trends, and an assessment of the relationship of the channel to the floodplain surfaces. To assess the potential for preferential paths, the following situations need to be considered:
- The channel has been systematically moving in one direction towards an obvious path for primary or secondary avulsion.
  - There is a continuous or intermittent linear or curvilinear depression or channel form connecting at the upstream end to the active channel that would be prone to flood in a large event.
  - Streamflow is directed at a portion of the floodplain such that floodwaters have an unimpeded, focused path.
  - The floodplain has a gradient greater than the adjacent channel, and the greater the difference the more likely avulsion will occur (Jones and Schumm, 1999). Avulsions typically occur where the down valley floodplain slope is greater than (>1x) the channel slope (Bridge, 2003). If the floodplain slope is 3 to 5 times greater than the channel slope, avulsion during a large flood event is probable (Bridge 2003).
  - Watershed and segment-scale evidence demonstrates that significant vertical bed aggradation due to increases in LWD or sediment (or both) is occurring or has occurred in the historical past. Evidence of the historic bed elevation should exist on any remaining adjacent surfaces, but can be buried. Specific evidence that supports the likelihood of vertical bed aggradation includes:
    - post-harvest or stream-cleaning channel degradation that has isolated historic floodplain surfaces,
    - channels with multiple floodplain surfaces that are close in elevation indicate that the channel bed elevation fluctuates,
    - in-channel sediment waves, commonly produced by concentrated landsliding, can be observed (through historic aerial photographs or cross sectional survey records such as those at gauging stations) as channel disturbance propagated downstream over time,
    - high variability in the current channel bed elevation, and
    - the presence of islands on higher surfaces.

For additional information, see Part 2.5 Technical Background for a discussion of how changes in wood and sediment budgets affect channel form and migration processes,

Erosion Hazard Area (EHA): Along some rivers there are lengths of channel where the stream is laterally eroding into a terrace or floodplain surfaces. Although the stream may not continue to erode in the same direction (it could shift back at any time) or at the same rate (the channel could reach equilibrium) over the long term, it may erode over the near term. For these stream segments, erosion rates of bank retreat and the CMZ setback distances can be calculated.

The erosion hazard area includes those areas outside of the HMZ and AHZ which are susceptible to bank erosion from stream flow and this can result in a potential near-term loss of riparian function and associated habitat adjacent to the stream (Figure 7a and 7b). Typically, the EHA will be comprised of portions of floodplain and terrace surfaces other than those within the HMZ and AHZ. Establishing an EHA is necessary for those situations where measurable undercutting or erosion on the order of feet per year or per flood event is currently taking place. In some reaches where channels are now permanently disconnected from their floodplain due to channel degradation, the CMZ may consist solely of the EHA. However, the CMZ will not extend further than the base of the valley hillslope or other such geologic controls to lateral channel movement.

Evidence of measurable or chronic bank erosion includes:

- The channel has visibly eroded into surfaces higher than those in the HMZ and AHZ during the record of historical aerial photography.
- There are meander bends with age progressive vegetation on the point bar, indicating that erosion into the far bank has been occurring.
- There are steep or vertical, unvegetated, non-cohesive banks along higher surfaces. See Part 2.2 Bank Erosion for additional guidance in determining if significant bank erosion is occurring if this situation exists.

The area to be included in the EHA can be calculated by averaging the historical erosion rate along the entire length of the channel segment or by calculating the erosion rate at a specific location where erosion may be concentrated.

To delineate the EHA for erosion into a terrace or non-HMZ/AHZ portion of the floodplain, the actual area(s) lost at each bank location is (are) delineated and measured using all historical aerial photographs. For segment-averaged erosion, these areas are added together. The individual or combined eroded area is divided by the length of terrace edge adjacent to the floodplain and then divided by the number of years of record used to get an average annual erosion rate. The erosion rate is then multiplied by the appropriate length of time to grow functional-size wood to get the average erosion setback along the eroding bank(s). For segment-averaged erosion, the length of eroding channel is measured along both sides of the channel, but does not include any length of channel or floodplain that abuts the valley hillslope.

$$AES = \frac{A \text{ (or } \Sigma A)}{L} \times \frac{1}{\Delta t} \times T$$

Where AES is the average erosion setback, A is the total eroded area or  $\Sigma A$  sum of total eroded areas over some time  $\Delta t$ , L is the length of eroding bank, and T is the length of time to grow functional wood.

Where the stream is eroding into floodplain surfaces or terraces, the EHA portion of the CMZ layout will protect the eroding bank edge. In addition to consideration of a CMZ, stream erosion of hillslopes and very high glacial terraces at the outside of meander bends and at the toes of deep-seated landslides are considered unstable slopes situations and are also evaluated under forest practices rules for unstable slopes (see Board Manual Section 16). As with other situations

of overlapping forest practices rules, the harvest unit layout should reflect the greater of the protections.

**Disconnected Migration Area (DMA):** The disconnected migration area (DMA) is the portion of the CMZ behind a permanently maintained dike or levee. The CMZ of any stream can be limited to exclude the area behind a permanent dike or levee provided these structures were constructed according to appropriate federal, state, and local requirements. As used here, a permanent dike or levee is a channel limiting structure that is either:

1. A continuous structure from valley wall or other geomorphic structure that acts as a historic or ultimate limit to lateral channel movements to valley wall or other such geomorphic structure and is constructed to a continuous elevation exceeding the 100-year flood stage (1% exceedence flow); or
2. A structure that supports a public right-of-way or conveyance route and receives regular maintenance sufficient to maintain structural integrity (Figure 19).

A dike or levee is not considered a “permanent dike or levee” if the channel limiting structure is perforated by pipes, culverts, or other drainage structures that allow for the passage of any life stage of anadromous fish and the area behind the dike or levee is below the 100-year flood level.

The Washington Department of Fish and Wildlife (WDFW) and the Indian tribes can often provide assistance in evaluating the potential for seasonal fish passage and use of the floodplain, as well as details on dike permitting. Applicants should also contact local, state, federal, and tribal entities to make sure that there are no plans to remove the structure.



Figure 19. CMZ disconnected by a public right-of-way.

## **CMZ REPORTING FORM**

### **Forest Practices Application/Notification**

To list the evidence and/or methodology used to determine the presence of a channel migration zone within the immediate vicinity of your forest practice activity.

Please enclose completed copies of the CMZ Office Review form, Field Evaluation form, and any other additional information used to determine the presence/absence of a CMZ.

1. Is the forest practice activity adjacent to a channel migration zone?

Yes. Continue with form.

No. Delineate RMZ.

2. What was the distance of channel walked? What was the length of CMZ boundary delineated?

---

3. Please check the component(s) present in your CMZ delineation.

Historical migration zone

Avulsion hazard zone

Erosion hazard area (attach erosion rate calculation sheet)

4. Check the appropriate box(es) that best matches floodplain configuration. For additional details refer to Part 2.3 Delineating the Channel Migration Zone.

simple floodplain

simple floodplain with terraces

complex floodplain, with

multiple surfaces

multiple terraces

alluvial or debris fan

braided channel

unconfined meandering stream

stable sinuous channel

5. Please indicate how you marked the outer edge of the CMZ on the ground.

---

---

*CMZ Delineation Scenarios:* The following different types or “scenarios” of channel migration are provided to facilitate CMZ delineation and the use of appropriate evidence and methods. Almost all rivers and streams with historic or active channel migration will fit into one of the following categories. Some of the delineation situations are very straightforward. Others are more complex, and it may take some additional fieldwork to be sure you have correctly identified the situation.

Read the following seven descriptions carefully and decide which situation best fits the stream segment in which you are delineating a CMZ. Each scenario includes the CMZ components likely to be included in the delineation and an example of delineation and field or analysis methods unique to those situations where appropriate.

**Scenario 1 - Simple floodplain abuts valley walls:** In this situation, one relatively flat floodplain surface, that is approximate in elevation to the bankfull channel, abuts the valley walls (Figures 20 and 21). There are no higher horizontal surfaces that could represent either additional floodplain or terrace. These conditions are most likely to be found where the channel is moderately confined (the valley width is approximately 2 to 4 bankfull widths – (Parts 2.6 and 2.7)).

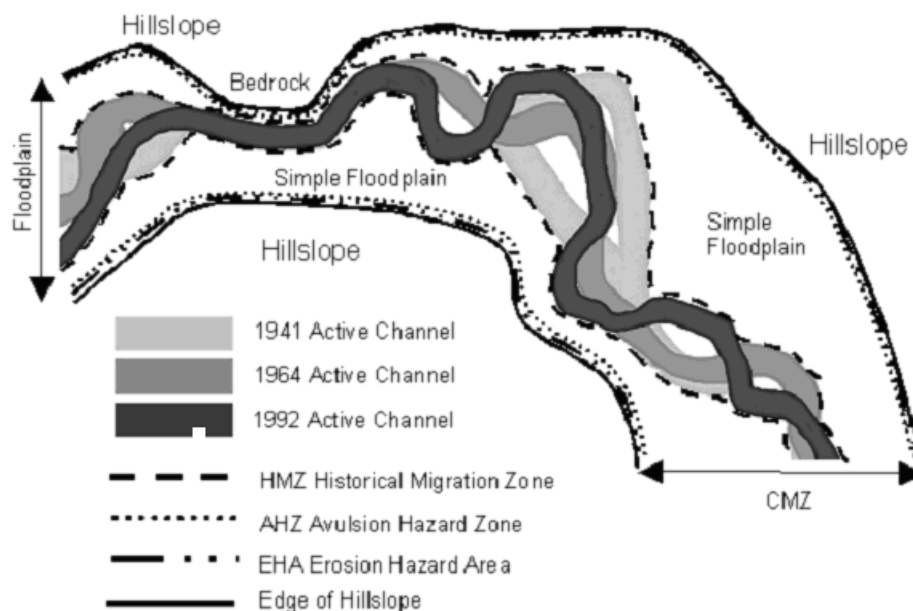


Figure 20. Simple floodplain abuts valley walls CMZ scenario in plan view.



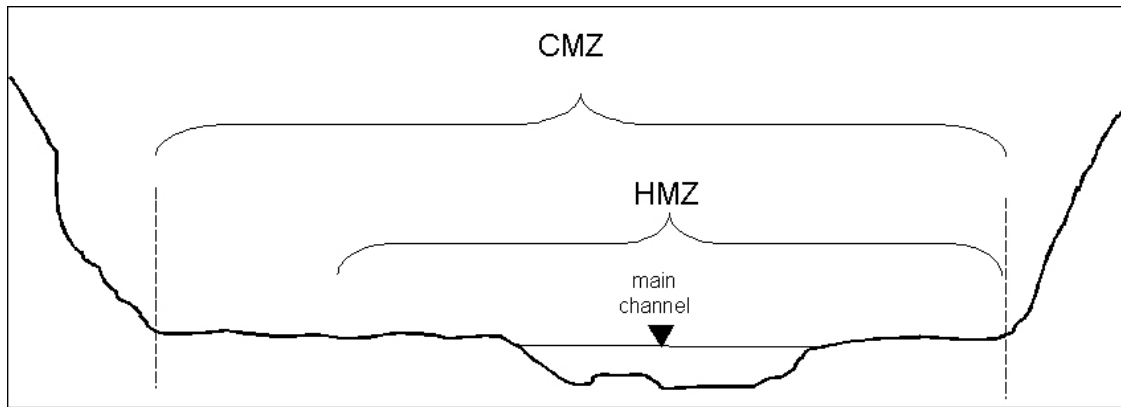


Figure 21. Cross sectional of the simple floodplain CMZ scenario.

In this situation, the simple floodplain is the channel migration zone, and will represent the historical channel locations (HMZ) in addition to any floodplain areas prone to avulsion (AHZ). The CMZ is the valley bottom, and the RMZ starts at the hillslope/valley-floor slope break. The RMZ extends up the valley wall, and its design must also protect any unstable slopes. Where migration is very active, the valley walls may be periodically undercut by the channel, creating over-steepened and unstable slopes (see Board Manual Section 16).

Scenario 2 - Simple floodplain with terraces: This situation is similar to the one above, except that the relatively flat floodplain surface, that is approximately the same elevation as the bankfull channel, abuts a terrace or terraces (Figures 22 and 23). The floodplain surface or the channel itself may intermittently abut a valley wall where there is no remaining terrace. If you are unsure that the higher surfaces are terraces, then work through the “evidence for a terrace surface” in Part 2.2. If you are still not sure that the higher surfaces are terraces, then assume that you have a complex floodplain with multiple surfaces and proceed to the delineation for that scenario below. This situation might be confused with the upper, narrow end of an alluvial fan (Scenario 4) if your designated segment does not extend a sufficient distance down valley.

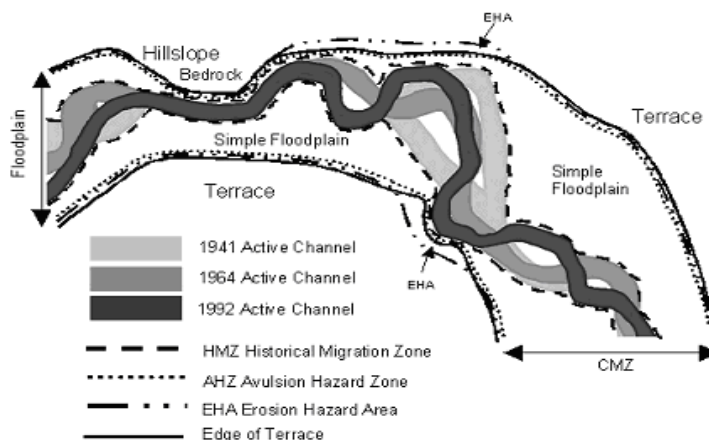


Figure 22. Simple floodplain with terraces CMZ scenario in plan view.

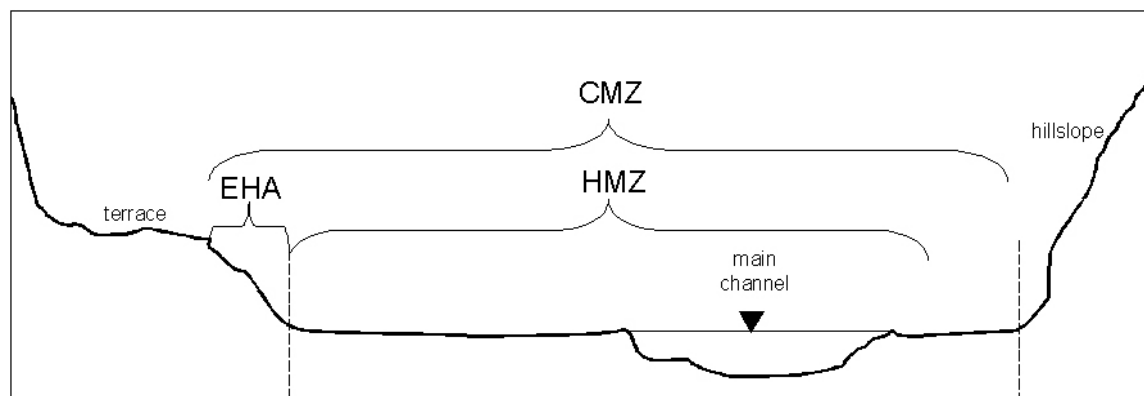


Figure 23. Cross sectional of the simple floodplain with terraces CMZ scenario.

As in the previous delineation, the entire floodplain lies within the channel migration zone, and will include the historical channel locations (HMZ) in addition to any floodplain areas prone to avulsion (AHZ). An erosion hazard area (EHA) may also be identified where rivers are still actively widening their floodplain by eroding the terraces.

Scenario 3 - Complex floodplain with multiple surfaces: In this situation, there are multiple surfaces of varying elevations within the floodplain (Figures 24 and 25). This situation may be caused by the interaction of sediment, debris, and water or variability in sediment and/or wood loading in the historic past, and indicates that the channel bed elevation fluctuates. Multiple floodplain surfaces may be absent where the channel abuts a terrace or valley wall within the segment. Multi-surfaced floodplains can exist for streams of varying sizes and confinements. The processes of channel migration under this scenario are primarily bank erosion and avulsion.

A helpful first step is to identify the surfaces as either terraces or floodplain by working through the “evidence for a terrace surface” and “evidence for a floodplain surface” criteria in Part 2.2. If you are still uncertain, assume you are in this category.

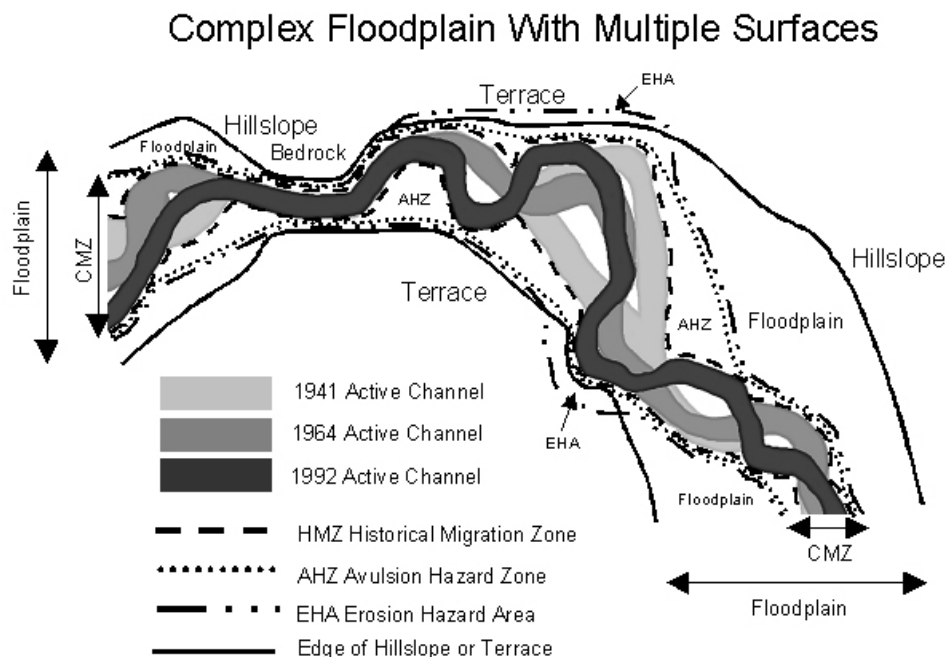


Figure 24. Complex floodplain CMZ scenario in plan view.

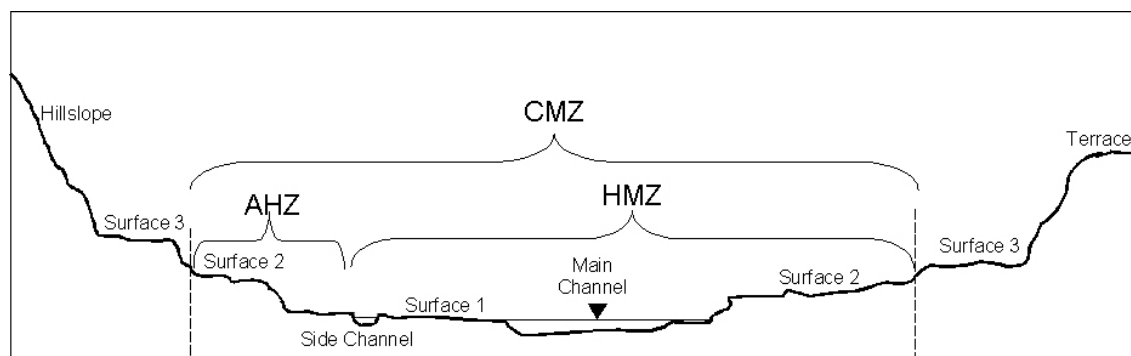


Figure 25. Cross sectional of the complex floodplain CMZ scenario.

Because of the complex floodplain features, this delineation scenario requires historical map and photo work in addition to extensive fieldwork to identify the CMZ components. The situation may require the collection of quality elevation data (e.g., cross sectional traverses or LiDAR data for large rivers). The quality elevation data is needed to link geographically isolated surfaces to each other down the length of the reach and across the river.

Much of the criteria for each of the CMZ components above can be applied to evaluate the channel migration potential where more than one floodplain surface exists. Because multiple surfaces imply fluctuations in channel bed elevation, emphasis should be placed on evaluating evidence for vertical bed elevation changes found at the end of the AHZ Section. Refer to Part 2.5 Technical Background for additional information and discussion of how changes in wood and sediment budgets affect channel form and migration processes.

When you are evaluating a “surface” in order to characterize it by the CMZ criteria listed above, the entire extent of that surface along the segment must also be evaluated for evidence of channel migration potential. The CMZ delineation for these complex floodplain situations may consist solely of the HMZ or any combination of the HMZ plus AHZ and EHA. Additional analysis is encouraged.

Scenario 4 - Alluvial or Debris Fans: Alluvial fans are a unique landform in the river valley. They are cone or fan-shaped deposits of sediment and debris that accumulate immediately below a significant change in channel gradient and/or valley confinement (Figure 26). The fan shape is created as the channel moves back and forth across the gradient transition depositing sediment. It is common for the stream to form distributary channels (channels branch but do not rejoin) as water flows down the fan. On varying time scales, the channel(s) will change location on the fan, seeking a lower elevation away from where it has most recently been depositing sediment. See Part 2.5 River Pattern for more information.

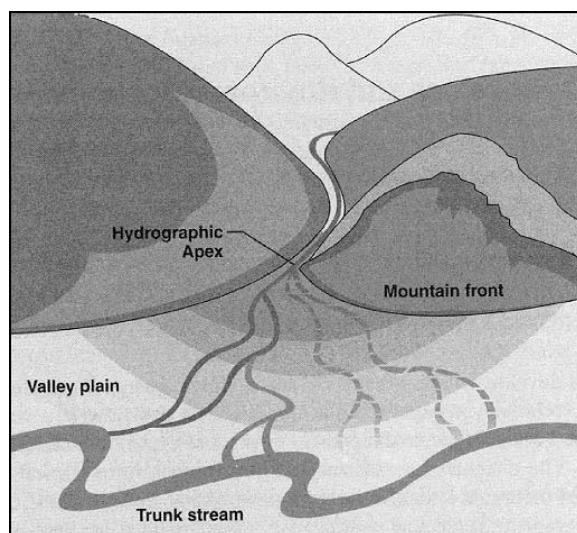


Figure 26. Environment where alluvial fans form (National Research Council, 1996).

Technically, the term “alluvial fan” refers to those features composed of stream-sorted alluvium; however, it is also commonly used to refer to fan features built by debris flow processes or a combination of alluvial and debris flow processes. Debris flow deposits are unsorted, and debris flows will often form a berm next to the channel. Trees on a fan subject to debris flow provide a buttress effect that limits the downstream extent of debris flow deposition, which is important for protecting human life or property inadvertently in the path of such events.

Surface gradients on alluvial fans are generally between 8 and 20%, but a fan built by debris flow or mass wasting processes can have steeper slopes. Both commonly exist:

- Where a smaller channel meets a larger channel;
- Where an abrupt change from narrow to wide valley width occurs; or
- Where an abrupt change from steep to gentle channel gradient occurs.

By definition, the channels on alluvial fans migrate and are therefore subject to CMZ delineation. Alluvial fans are also identified as “sensitive sites” in WAC 222-16-010 and no timber harvest is

permitted within an alluvial fan (WAC 222-30-021(2)(b)(vi) and -022(2)(b)(ii)(C)(IV)). An alluvial fan will need CMZ delineation where historical map and aerial photograph and field evidence demonstrate that channel migration has occurred or can occur due to active fan building processes upstream. Channels can be located anywhere on the fan and are best observed starting from the apex or upstream portion of the fan and following them downstream. The CMZ will generally encompass the entire fan surface because of the difficulty in predicting the future channel location.

All or some portions of the fan may no longer be subject to channel shifting if the fan-building processes have ceased or diminished. The degree of channel incision at the fan head is not a reliable indicator of the lack of channel shifting potential, as infrequent but large flood events or debris flows can rapidly fill the channel. A relict fan may have one or more small modern fans building at the downstream margin of the larger feature. In this situation, only the smaller, active fan has a CMZ. Technical expertise may be necessary to evaluate the age and frequency of fan-building processes.

A related landform is the delta, which forms distributary channels as water slows and deposits sediment upon entry into a lake or estuary.

**Scenario 5 - Braided Channels:** A braided stream is divided into several channels that branch and rejoin around bare or sparsely vegetated sand/gravel/cobble bars (Figure 27). Braided streams are characterized by high sediment loads relative to the transport capacity of the stream, low sinuosity, rapid shifting of bed material, and continuous shifting of the locations of the low-flow channels (Knighton, 1998). The braided channel pattern is partly stage- or water level-dependent. At higher discharges the bars are flooded and the river displays a single channel. A braided stream pattern is common on streams fed by glaciers. See Part 2.5 River Pattern for more information.



*Figure 27. Braided river.*

Examples of some rivers known to have braided segments include the upper Quinault River, the upper Carbon River, the Mowich River, and part of the upper White River in Western

Washington and the upper Wenatchee River, the north and south forks of the Touchet River, the Entiat River, and Chiwawa River in Eastern Washington.

Braided channels are each unique in their migration behavior and potential, and their delineation may require both extensive fieldwork and detailed aerial photography analysis. Where braided channels extend valley wall to valley wall, or have only small pieces of terrace or low floodplain on the valley floor, the entire valley floor is included in the CMZ and the RMZ extends up the hillslope. As in the first and second delineation scenarios, there may also be unstable slopes that require additional protection or eroding terraces that require an EHA. Braided channels with a floodplain will require the same CMZ evaluation as the complex floodplain in scenario 3 above, and expert delineation is encouraged.

Scenario 6 - Unconfined Meandering Streams: As used here (Forests and Fish Report, 1999), unconfined, meandering streams are 5<sup>th</sup> order and larger Type S waters with bankfull widths greater than 50 feet and gradients of less than 2% with the following additional characteristics:

- The waters are sinuous, primarily single-thread channels that have a distinct meandering pattern readily observable on aerial photographs.
- Remnant side-channels and oxbow lakes often create wetland complexes within the associated channel migration zone.
- A diverse set of vegetation can grow within the associated channel migration zone including cedar, spruce, hardwoods, and wetland vegetation on wetter sites and Douglas-fir, spruce, hemlock, and true firs on drier surfaces.

A river creates these characteristics through the process of progressive bank cutting on the outside of a meander bend and subsequent deposition on the inside of the bend. A river maintaining its floodplain in this manner is generally considered in a state of dynamic equilibrium with the volume of water and sediment it carries (Knighton, 1998). The elevation and basic pattern and average geometry (width, depth, and cross sectional shape) of the channel do not change (Figure 28); but the channel location migrates across the valley horizontally, and the meander pattern migrates down valley over time (Figure 29). The meander loops or bends are also subject to cut-off by avulsion (Figure 40 and Part 2.5). Both progressive channel migration and avulsion processes create the remnant side-channels and oxbow lakes. The valleys of such rivers are generally wide relative to the size of the channel. The time frame for migrating channels to move across their floodplains varies from decades to hundreds of years. The rate of bank erosion is dependant on the scour energy of the stream (direction and magnitude) and the erodibility of the bank material.

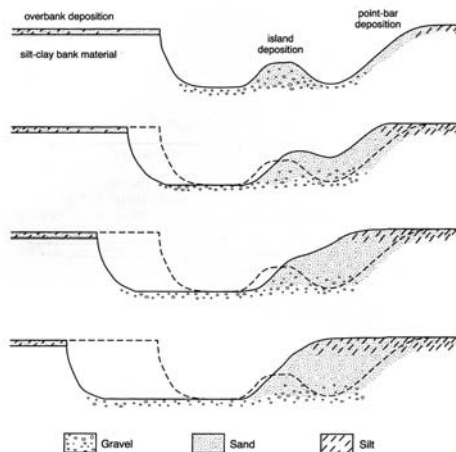


Figure 28. Progressive channel migration shown in cross section (Drawing: Knighton, 1998).

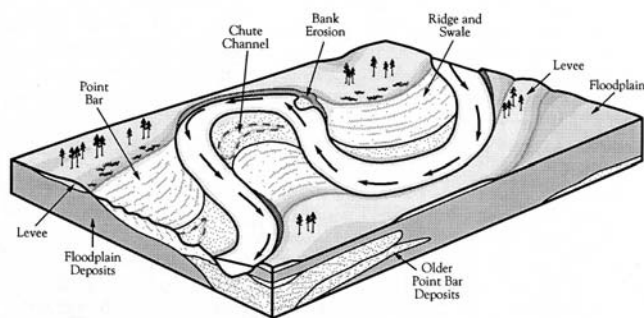


Figure 29. Progressive channel migration shown in plan view (Drawing: Mount, 1995).

Likely locations for rivers exhibiting this behavior include low gradient valleys below the outlets of lakes and those some distance away from primary sediment sources. The size of available sediment for transport is a factor in maintaining a single channel. There may be a few rivers in Washington where aerial photo review and field evidence show that the river migrates primarily in this manner. The methods for CMZ delineation of these stream types are described below.

For large sinuous, or meandering, rivers that are unaffected by permanent dikes or levees and show historical or photographic evidence of the channel migration processes described above, the extent of the CMZ can be determined by one of the following methods:

1. Using aerial photos to determine the amplitude of the meander wavelength described below; or
2. Evaluating the average annual bank erosion rate as described for the Erosion Hazard Area above.

As illustrated in Figure 28, the meander bends of a river have a wave pattern characterized by a general wave-length and amplitude. The amplitude of the meander bends can be used to help delineate the approximate extent of the channel migration zone (Method 1). From aerial

photographs, two generally parallel lines are drawn to encompass the maximum amplitude of the meander wave and any meander cutoffs or oxbow lakes in a given stretch of river. These parallel boundaries can be roughly located in the field using landmarks identified from aerial photos to place the CMZ boundary. Changes from riparian to upland vegetation communities, geologic controls, remnant side-channels, oxbow lakes, and associated wetland complexes can be used as field indicators to help identify the extent of the meander belt. The CMZ delineated in this manner is assumed to encompass the historic migration zone, the avulsion hazard zone, and the erosion hazard zone.

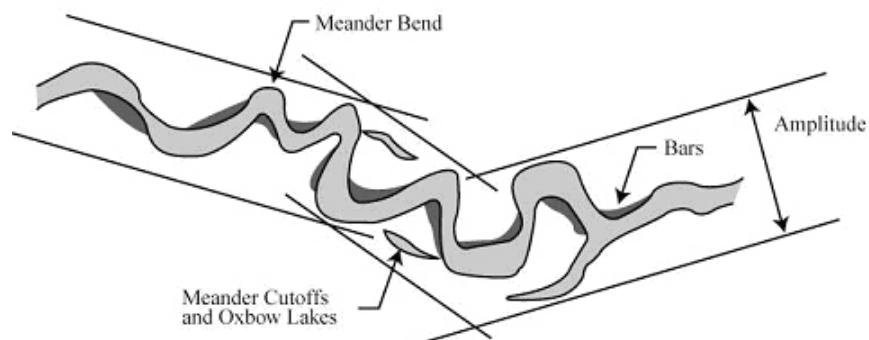


Figure 30. Method 1: CMZ equals area within amplitude of meander bends.

When using Method 1, the segment should also be evaluated for the potential for primary avulsion outside of the meander belt (see avulsion hazard zone). If avulsion outside of the meander belt has occurred historically, using a different scenario and delineation method may be necessary. If it's unclear where to draw these lines to include or exclude some meander pattern floodplain features, an expert analysis is recommended. Method 2, calculating the average annual bank erosion rate, is advised where the river is eroding into a terrace edge or the stream has been eroding laterally across the floodplain in a single direction either throughout the entire segment, a portion of it, or at a single location.

Scenario 7 - Stable, Sinuous Channels: Bare or exposed banks alone are not necessarily an indicator of channel migration. Segments of rivers or streams that are unconfined, low gradient, and sinuous may be stable and may not exhibit active bank retreat or lateral migration over time if erosion or avulsion processes are inactive. Stable sinuous streams or segments have a gradient generally less than 1% and silt or clay banks. In stable stream segments, the bankfull channel position shifts negligibly over the span of the photo record. These stable reaches do not need CMZ delineation.

Included in this category are those wetland channels that have no ability to migrate because they are very low energy and transport low volumes of sediment. These streams have very low gradients (e.g., <0.05%) and are narrow and deep (channel width < 3 times channel depth). Their substrate is predominately silt or fine organic particles, banks are stabilized by the roots of wetland vegetation, and >90% of the water surface is smooth. These channels are not common on forested lands except in certain low elevation, coastal plain situations (e.g., Willapa Bay). This does not include distributary channels in deltas or estuaries where the stream meets a larger water body such as a lake, river, or the ocean).



#### 2.4 CMZ Review and Additional Analyses

Pre-application reviews by stakeholder groups can be useful in identifying important processes affecting channel migration and determining additional information necessary to delineate a channel migration zone.

An interdisciplinary team (I.D. team) is recommended for those situations that are complex or potentially controversial. An I.D. team will benefit if members have familiarity with the stream system and/or have an understanding of geomorphic and channel processes.

Additional analyses are recommended for CMZ delineations of large rivers and multiple river segments, alluvial fans, and braided channels. These analyses may include information such as a thorough review of channel behavior over the historical record, a synthesis of the watershed processes driving channel migration, a topographic analysis (channel cross sections, longitudinal profile, or LiDAR), the origin, composition, and erodibility of valley fill and features, and any additional analyses appropriate to the situation. CMZ delineation is a relatively recent concept, and no one method of analysis has been adopted or prescribed. Various geomorphic, engineering, and modeling methods can be applied to channel migration delineation (FEMA 1999).

#### 2.5 Technical Background

River and stream channels are constantly adjusting to changes in flow, sediment, and other debris loads. The tendency for a channel to adjust both vertically and horizontally to these variable inputs of mass can cause it to move laterally across its valley. The concept of delineating the area where the channel is prone to move, or the *channel migration zone* (CMZ), comes from an acknowledgment of these natural processes and the need to alter land use practices to accommodate them.

To aid the field practitioner in understanding and predicting the extent to which a channel may move, an overview of the processes involved in channel movement is provided here. The concepts conveyed below are helpful for understanding the definitions related to channel migration zone contained in the Forests & Fish Report (WSDNR et al., 1999), which provides the original basis for the CMZ rule. This information is also useful as a reference for complex or difficult CMZ delineations. The following technical background draws from several classic texts on river process (Leopold, Wolman, and Miller, 1964; Schumm, 1977; Dunne and Leopold, 1978; Mount, 1995; Knighton, 1998; Wohl, 2000) and from current work in the Pacific Northwest.

*River Systems:* Rivers are essentially agents of erosion and transportation, removing the water, sediment, and debris supplied to them from the land surface to the oceans or other basins. In performing this work, rivers have evolved over time to their present configuration.

The character and behavior of the stream system at any particular location reflects the net effect of a suite of independent variables that act at the landscape, local basin or channel reach scale and exert control on the dependent channel morphology. At the landscape scale, the combined influences of climate, geology, and land use determine the suite of processes controlling the delivery and rate of water and sediment to a stream (Knighton, 1998) (Figure 31). Climate dictates seasonal precipitation patterns and temperature, thereby influencing the type of vegetation present and general runoff patterns (e.g., snowmelt versus rain-dominated). Regional geology influences topographic relief, valley morphology, types of erosional processes operating

(e.g., shallow rapid soil slips, rock fall, earth flows, soil creep, or deep weathering of the rock), as well as stream chemistry.

Within a basin, differences in rock type and relief strongly influence the slope and physical characteristics along the stream channel. Land use within a basin can both directly and indirectly influence channel morphology. Direct land use effects on morphology include dams, river regulation, channelization, gravel mining, and navigation maintenance. Indirect effects on morphology include forest cutting and clearance, road building, upslope mining, agriculture and urbanization (Knighton, 1998; Wohl 2000). The *flow regime*, which is defined as the magnitude, frequency, duration, timing, and rate of change of all flow events through time at a particular location within a basin (Poff et al. 1997), is the cumulative result of climate, geology, topography, and land use. All of these independent variables affect each portion of a river or stream.

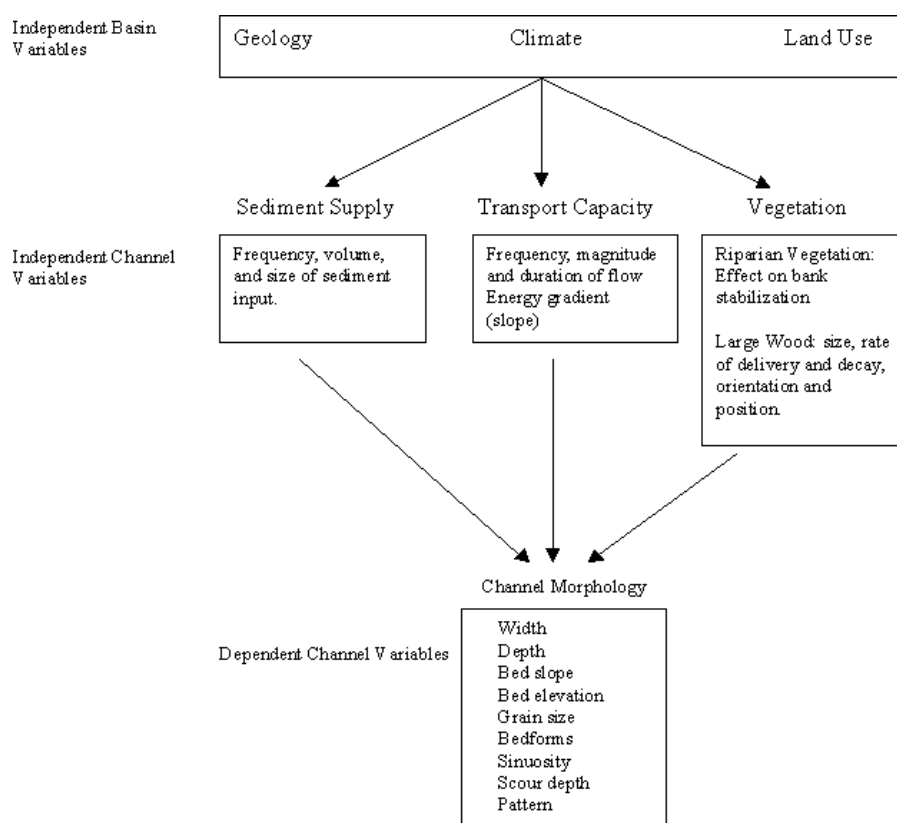


Figure 31. Independent controls on channel morphology and the dependent variables subject to change or adjustment (Diagram: modified from Montgomery and Buffington 1993).

A number of concepts and classification systems have been developed to describe the river system and to help us organize our understanding of river processes. Understanding these ideas will help us predict where channels are prone to migrate within a catchment. Classically, rivers were viewed as lengthwise systems where both physical (Schumm, 1977) and biological (e.g., the River Continuum Concept, Vannote et al., 1980) forms and processes change gradually downstream (e.g., Mackin, 1948). In general terms, a river develops systematic downstream changes in shape and form based on increasing discharge and decreasing gradient as it transitions

from the steep sediment source headwaters, through a zone dominated by transportation of sediment, to a zone of long term sediment storage and transport (Figure 32). A downstream change in physical processes also occurs as rivers become less directly coupled with hillslope water and sediment sources (Schumm, 1977; Montgomery, 1999; Church, 2002). Applied on a broad scale, these relationships are generally true, and would suggest that channel migration is likely in floodplain valleys and mainstem rivers located at lower elevations or gradients in the system.

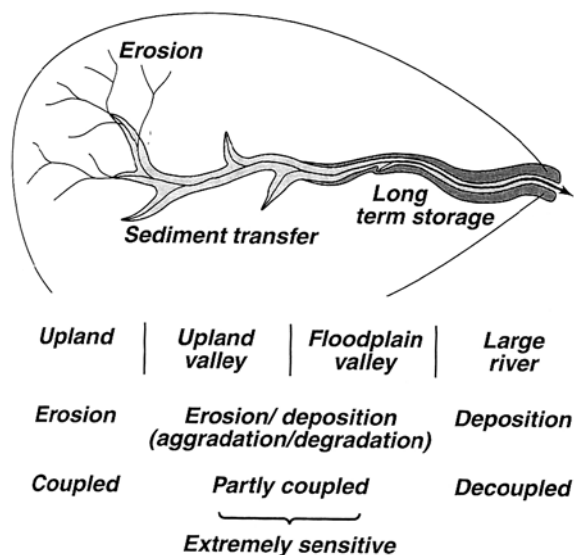


Figure 32. Watershed map showing the principal zones of sediment behavior (Church, 2002).

Given a closer look, however, most rivers will not always transition gradually and continuously downstream. Idealized, smooth, concave-up bed elevation profiles give way to stepped profiles (Figure 33). Local controls such as differences in bedrock type or structure, tributary junctions, landslides, variation in valley width, and storage of sediment and wood all influence the location and scale of these gradient steps (Rice and Church, 2001; Church, 2002). These local controls also interrupt the downstream fining of sediment sizes predicted by the river continuum theory and introduce variability in stream energy (Rice and Church, 1998; Knighton, 1999), which influences the rate of sediment accumulation and transport within a step or channel reach. Termed the “river discontinuum” theory, it predicts a patchy arrangement of channel form and response in the downstream direction (Figure 34) and suggests that channel migration may occur anywhere along the river profile (Ward and Stanford 1983, 1995; Ward et al., 2002; Poole, 2002).

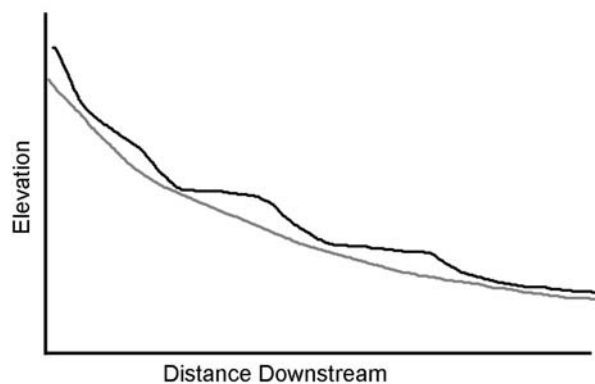


Figure 33. Comparison of an idealized river (gray line) to the more realistic profile (black line) from headwaters to mouth.

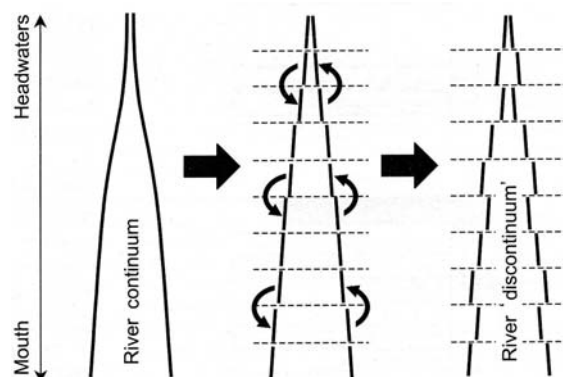


Figure 34. Different conceptual models of how rivers change in the downstream direction (Drawing: Poole, 2002).

Despite their general lower elevation and gradient locations, floodplain reaches containing alluvial deposits of various scales can exist throughout a river system. The river network consists of alternating reaches with variable gradient and valley width (Figure 35). In reaches where gradient diminishes and valley width increases, sediment and organic material deposition can lead to channel adjustment and migration. Lateral channel migration through these valleys provides a mechanism of sediment exchange and serves to create and maintain these floodplain deposits over time.

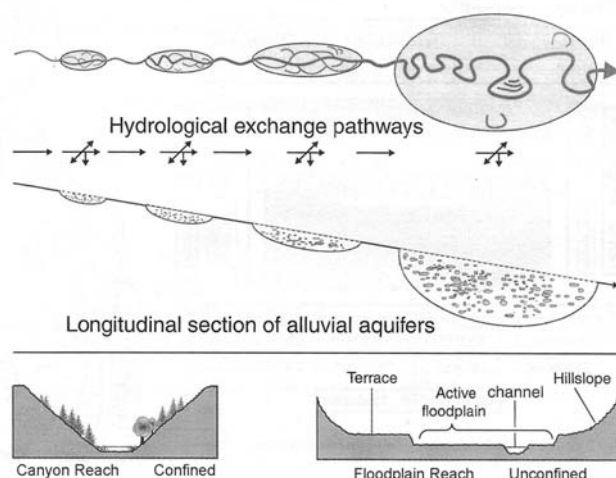


Figure 35. The channel network shown as a series of confined and unconfined reaches. Additionally, hydrologic exchange pathways are shown for the longitudinal, lateral and vertical dimensions (Drawing: Ward et al., 2002).

River systems are described in four dimensions: three spatial planes (cross section, long profile, and planview) and time (Figure 36). Channel geometry (width and depth) and confinement are

derived from cross sections and used to evaluate the area through which water and sediment are moving. Channel gradient (potential energy) is illustrated in profile and channel patterns are conveyed in planview. Changes occur in each of these planes with every flow event that alters the channel bed or banks.

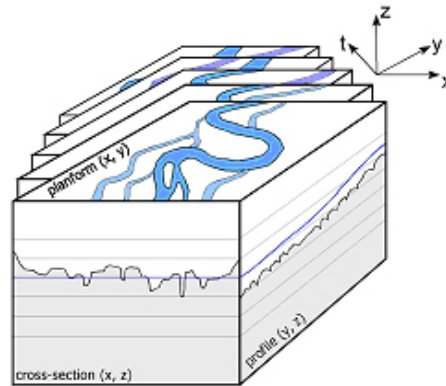


Figure 36. The four dimensions typically used to describe the morphology of a river: Physical space ( $x, y, z$ ) and time ( $t$ ). Three two-dimensional planes are: 1) cross section ( $x, z$ ), 2) long profile ( $y, z$ ), and 3) planview ( $x, y$ ). The  $x$ -axis extends perpendicular to the river channel and its valley, the  $y$ -axis parallels the valley, and the  $z$ -axis is vertical.

Schumm (1985) defines three major categories of stream channels: bedrock, semi-controlled, and alluvial. Bedrock channels are composed of and controlled by bedrock. This category of channel is generally stable over time and does not change its position unless there are weak sections of bedrock that allow the channel to shift laterally. A channel may also be non-alluvial when materials that were not transported by the river under current conditions bound it. Such examples include channels that are deeply incised into hillslope or glacial deposits. Semi-controlled channels have local controls that resist channel movement. Local controls can be areas of bedrock, resistant alluvium, or large wood and logjams (Schumm 1985; Abbe and Montgomery 2003). Alluvial channels are formed in and flow through the sediment transported by the river, referred to as alluvium. Since alluvial channels are shaped by the volume of water and debris load they carry, they are also self-adjusting to alterations that change the timing and volume of flow, wood, and sediment load. It is the alluvial channels that have the capacity to build floodplains and migrate laterally.

The relationship between a channel and the valley through which it flows is fundamental to channel migration. The degree to which a channel is deflected by the valley walls or by resistant terraces is known as confinement (Kellerhals et al., 1976). Many applied scientists use some description of valley confinement to define hillslope constraint on channel processes. Although confinement is often reported as the ratio of average valley width to average channel width (e.g. Cupp, 1989), little empirical data exists to support a numerical interpretation of this relationship. However, it remains a useful relative measure. Rivers and streams unconfined by hillslopes can also be artificially constrained by dikes or road grades constructed on the floodplain or in the channel itself.

In contrast to channel confinement, channel *entrenchment* is the relationship between the channel and the relatively flat surfaces on the valley floor that may be prone to flooding at some

maximum stream discharge (Galay et al., 1973; Kellerhals et al. 1976). A qualitative definition of entrenchment is the vertical containment of a river and the degree to which it is incised within a valley floor (Kellerhals et al., 1972). Although attempts have been made to quantify entrenchment as the ratio of average *flood-prone width* to the average channel bankfull width within a reach (e.g. Rosgen, 1994), little empirical data exists to support precise numerical classifications. Flood-prone width refers to the width of the stream at some maximum stream discharge (Galay et al., 1973) (Figure 37). Channel entrenchment can occur in response to natural processes (e.g., tectonic uplift) or human disturbance (e.g., channel clearing and straightening, harvest and clearing of floodplain forests, urbanization, upstream impoundments).

*The Floodplain:* The river floodplain is defined as the relatively flat area or berm adjoining a river channel and actively constructed by the river in the present climate by a combination of progressive lateral migration, channel creation and abandonment, and overbank sediment deposition from periodic inundation. Floodplain inundation can result from any combination of overbank river and tributary water at high discharge, hillslope runoff, groundwater, and direct precipitation. Floodplains may not be uniform or homogeneous flat surfaces, and can consist of irregular or multiple surfaces at different elevations that reflect vertical differences in the channel bed resulting from reach scale scour or fill and changes in flow regime, sediment supply and wood loading.

The height at which the channel overflows its banks is called the bankfull *stage* and corresponds approximately to the discharge at which the channel characteristics are maintained. The floodplain is, by definition, the valley level corresponding to the bankfull stage, or slightly less than bankfull if natural levees exist. Areas outside the bankfull channel (i.e., floodplain) are areas of short- or long-term sediment storage. The relatively flat valley bottom of the floodplain composed of river alluvium is the most direct evidence of lateral migration (Dunne and Leopold, 1978). Because channels are rarely in equilibrium and constantly undergoing adjustment (particularly in areas with historic forest clearing (Wolman and Leopold, 1957, Lisle and Napolitano, 1998; Wohl, 2000), floodplain and bankfull elevations change and are therefore not constant through time.

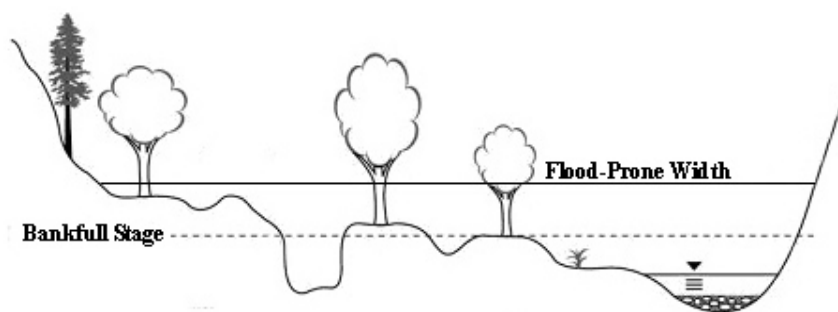


Figure 37. Simplified valley cross section of alluvial valley bottom illustrating the effects of various stages on channel width.

Field determination of bankfull stage is difficult when the floodplain is narrow or not flat or well defined. The difficulty is greater in foothills and mountains (Dunne and Leopold, 1978) because processes in addition to the floodplain building process described below are operating (Part 1 Bankfull Channel Features and Part 2.5 Magnitude and Frequency of Channel-forming Events).

The bankfull concept was developed for alluvial channels and does not apply to bedrock bounded or confined channels.

*Floodplain-building Processes:* Floodplains represent areas where river borne sediments (both bedload and suspended sediments) are stored, at least temporally, within the valley. Floodplains play an important role in conveying high flows, diffusing flood levels downstream, and exchanging organic and inorganic material. Dominant floodplain building processes include overbank deposition of sediment (both fine or coarse), bar deposits in actively meandering rivers, and residual deposits associated with channel creation and abandonment. The sediment and debris stored in a floodplain are eventually re-introduced to the channel at varying time scales and conveyed further downstream. Floodplain river systems often have multiple types of interacting channels, which aid in floodplain building processes and the conveyance of water longitudinally and laterally. Secondary channels carry water (intermittently or perennially in time; continuously or interrupted in space) away from, away from and back into, or along the main channel. Anabranch channels are the most common form of secondary channel, which are diverging branches of the main channel that reenter the main channel some distance downstream. Secondary and anabranch channels can be subdivided into: side channels, wall-based channels, distributary channels, abandoned channels, overflow channels, chutes, and swales.

A river maintaining a floodplain through the process of progressive bank cutting on the outside of a meander bend and subsequent deposition on the inside of the bend (Figures 38 and 39) is considered in a state of dynamic equilibrium with the volume of water and sediment it carries (Knighton, 1998). The elevation and basic pattern and average geometry (width, depth, and cross sectional shape) of the channel do not change; but the channel location migrates across the valley horizontally, and the meander pattern migrates down valley over time. However, this process can be short circuited by dramatic shifts in the position of the channel through avulsions.

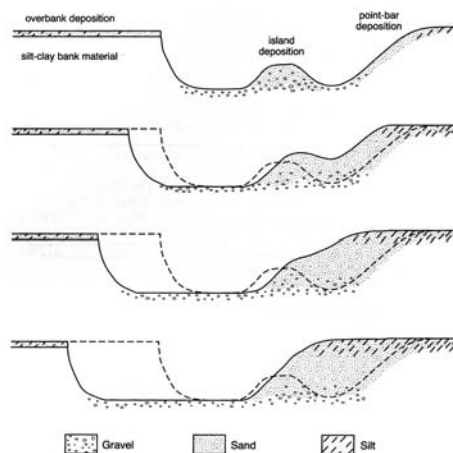


Figure 38. Progressive channel migration shown in cross section (Drawing: Knighton, 1998).

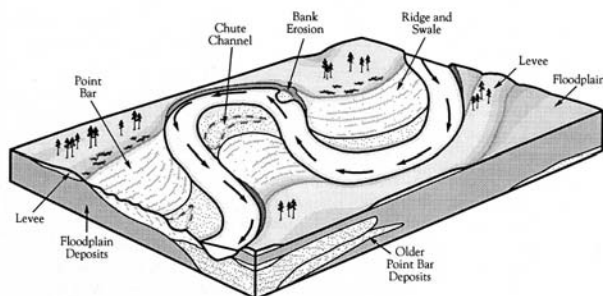


Figure 39. Progressive channel migration shown in planview (Drawing: Mount, 1995).

Channel avulsions are defined as relatively sudden and major shifts in the position of the channel to a new part of the floodplain (first-order avulsion) or sudden reoccupation of an old channel on the floodplain (second-order avulsion) or relatively minor switching of channels within a braid train or other active channels (third-order avulsion) (Nanson and Knighton, 1996). Avulsions onto floodplain deposits can occur at a variety of scales and channel sizes. Primary avulsion paths can be guided by the presence of poorly defined topographic low points along the floodplain, and secondary avulsion paths can follow better defined secondary or abandoned channels on the floodplain. The shifting of the main channel into an active side channel or braid (third-order avulsion) is not considered a classic channel avulsion per se, but rather represents the typical channel-switching phenomenon of anabranching rivers as defined by Nanson and Knighton (1996) (Part 2.5 River Pattern).

Avulsions occur when the channel capacity to convey water, sediment, and wood is reduced. Avulsions can be caused by any combination of a downstream decrease in the main channel slope, an increase in slope down-valley along the floodplain as compared to the channel slope, local sediment build up in the channel called aggradation, wood debris jam formations, ice jams in colder climates, vegetation encroachment, hydrologic change in peak discharge, and/or stream capture from adjacent or secondary channels (Jones and Schumm, 1999; Bridge, 2003). Typically, as a channel becomes more sinuous as it actively meanders, the channel length increases (relative to the same down valley distance) and the slope decreases, slowing the water, which favors sediment deposition and higher water surface elevations. This condition increases the potential energy for eroding a new, steeper, shorter, and less resistant course through a floodplain meander deposit, resulting in a meander chute (or neck) cut-off or an avulsion (Figure 40). These processes can be aided by stream capture from the headward erosion of secondary channels draining the floodplain (Thompson, 2003) and large woody debris deposits in the old main channel (Abbe and Montgomery, 2003).

Empirically, avulsions or cut-offs typically occur when the floodplain slope (i.e., potential avulsion path) is greater than the channel slope ( $S_f/S_c > 1$ ) (Jones and Schumm, 1999; Bridge 2003), the ratio of the bend radius of curvature to channel bankfull width is less than two ( $r_c/w < 2$ ) (Lewis and Lewin, 1983; Knighton, 1998), or the channel sinuosity (channel thalweg length vs. straight-line valley length) is greater than one and a half ( $L_c/L_v > 1.5$ ) (Leopold et al., 1964). The occurrence of an avulsion also obviously depends on the prerequisite ratio of a high discharge event above a threshold discharge for avulsion ( $Q_{max}/Q_{threshold}$ ) (Bridge, 2003) or other



complicating factors such as bed aggradation or wood debris jam formations (Jones and Schumm, 1999; Bridge, 2003).

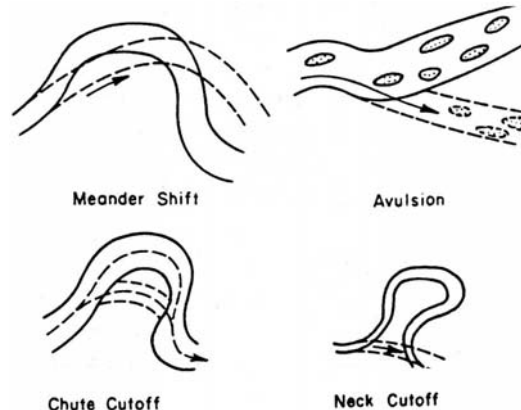


Figure 40. Types of channel changes (modified from Schumm, 1985). Solid lines indicate pre-change channel position. Dashed lines indicate post-change channel position.

*Role of Wood in Streams:* “Gravel, sand, and silt collect in the dead water, behind the drift piles, strengthening them and preventing the river from returning to its original bed. Evidences of this action are plentiful, and, in the narrow valley of the upper reaches, show that the river has been forced from the hills on one side to those of the other, a distance of  $\frac{1}{2}$  mile (0.81 km) or more, and the original bed has become overgrown with very heavy timber.” From a description of the White River, near Auburn, Washington in the early 1900s (Wolff 1916).

Wood debris can play a significant role in channel migration throughout a fluvial network from headwater bedrock channels (e.g., Montgomery et al., 1996, Massong and Montgomery, 2000) to large alluvial rivers (Abbe and Montgomery, 2003; Lancaster et al., 2001; O’Connor et al., 2003). The majority of streams and rivers are depleted in wood debris, and historic conditions may not reflect conditions associated with intact, mature riparian forests (e.g., Maser and Sedell, 1994).

Wood debris (i.e., branches, tree trunks with and without root mass) is an important element of the solid material introduced to rivers. Just like the sediment load of a river, wood debris ranges widely in its physical characteristics such as size, shape and density. Generally the larger pieces of wood debris tend to be more stable and become a significant factor increasing the frictional resistance that flow encounters (e.g., Shields and Gippel, 1995, Gippel et al., 1996, Brooks and Brierley, 2003). Wood debris, either as individual snags or accumulations (i.e., logjams), often creates obstructions impeding flow and sediment transport and thereby altering channel morphology. By dissipating energy through a general increase in channel roughness or directly impounding flow, wood effectively reduces the sediment transport capacity of the channel and traps sediment and other wood that would have otherwise passed through the channel. The resulting sediment storage upstream of wood accumulations raises the channel bed elevation and increases the frequency of overbank flow and the probability of a channel avulsion (e.g., Lisle, 1995; Hogan et al., 1998; Lancaster et al., 2001; Abbe et al., 2003). New channels develop where flows find an unobstructed path around the wood obstruction. This process can occur from steep headwater channels (e.g., Massong and Montgomery, 2000) to large rivers (e.g., Sedell and

Luchessa, 1982, Triska, 1984, Abbe and Montgomery, 1996, 2003). Wood accumulations impose a strong influence on vertical (profile) and lateral (planform) migration of streams and rivers. Logjams can raise a channel several meters and move a river from one side of its valley to another, including large rivers (Abbe, 2000; Abbe and Montgomery, 1996, 2003; O’Conner et al., 2003).

*Other Valley Forming Processes:* In mountain valleys subject to recurrent debris flows, debris flow deposits form the valley floor in many reaches. The defined stream channels carved in these deposits are impermanent, since subsequent floods may dam or divert or greatly enlarge them. Where such debris flows are important, levees, berms, or terraces may be distinguished and even ascribed to particular flood years. However, a floodplain, as defined above and having a constant frequency of overflow, cannot be identified or does not exist (adapted from Dunne and Leopold, 1978).

In the Pacific Northwest, rivers may also occupy valleys formed by quiescent processes from former continental or alpine glaciation or volcanic mudflows (Booth et al., 2003). A river or stream that appears too small to have eroded the valley in which it occupies is called an underfit stream (Knighton, 1998). An example of an underfit stream is the White River, which flows through a valley produced by multiple glaciations combined with periodic deposition of volcanic related mudflows (lahars) and debris flows originating from the Mount Rainier volcano (Collins, et al. 2003).

Alluvial fans are a unique landform in the river valley. They are cone- or fan-shaped deposits of sediment and debris that accumulate immediately below a significant change in channel gradient and/or valley confinement (Figure 41). The fan shape is created as the channel moves back and forth across the gradient transition depositing sediment. Technically, the term refers to those features composed of sediment deposited by running water; however, it is commonly used to refer to those features also built by debris flows that simply overflow the channel and spread out onto the fan surface. Debris flow deposits can be later reworked by the stream and deposited further down the fan surface. Generally, a gently sloping fan will be alluvial, and a fan built by debris flow or mass wasting processes will have steeper sides. Both commonly exist:

- Where a smaller channel meets a larger channel;
- Where an abrupt change from narrow to wide valley width occurs; or
- Where an abrupt change from steep to gentle channel gradient occurs.

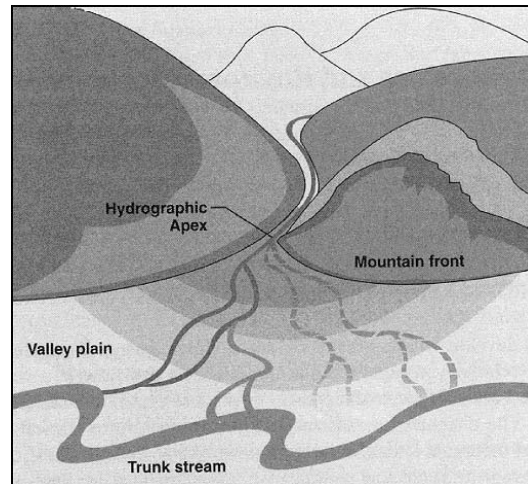


Figure 41. Idealized alluvial fan environment (National Research Council, 1996).

All or some portions of the fan may no longer be subject to channel shifting if the fan-building processes have ceased or diminished. The degree of channel incision at the fan head is not a reliable indicator of the lack of channel shifting potential, as infrequent but large flood events or debris flows can rapidly fill the channel.

*Magnitude and Frequency of Channel-forming Events:* River channel form is a product of all flow and sediment transporting events and the sequence of those events through time. Fluvial systems also have memory for past events, as partially displayed in the current channel form. Of the total sediment load, bed-load transport has the greatest effect on channel form (Knighton, 1998). While all flow events cumulatively do influence current channel form, not all events produce the same effect or occur at the same flood frequency. This has led to the theory that a dominant discharge controls the gross channel geometry.

In many alluvial streams, channel size (i.e., width, depth) is established by flood events that occur frequently, which over time accomplish the most work and move the greatest volume of sediment (Wolman and Miller, 1960). While larger flood events, those that occur on average every 50 years, do more work and move more material than small events that occur on average every 2 years, the cumulative work and sediment movement from twenty-five ‘2-year’ floods over fifty years is usually far greater than the one ‘50-year’ flood. Thus, the dominant discharge that may control gross channel form is related to the effective discharge, which over the long term, transports more bed-load sediment than any other flow (Knighton, 1998). The dominant and effective discharges for bedload have been related to flow events that just fill the channel, or the bankfull flow, for alluvial systems in humid climates. The bankfull flow represents a discharge that is reached in most years (e.g., every 1-2 years) in undisturbed watersheds in humid climates (Leopold, Wolman, and Miller, 1964).

However, regionally and world wide, there is great variability among the frequency in flows that just fill the banks of the channel, especially in mountainous or arid terrain and human modified environments. The bankfull discharge may not occur frequently nor be the most effective discharge. In addition, the bankfull channel cannot always be well defined in the field. In streams with highly variable flow regimes or resistant channel boundaries (e.g., smaller, higher elevation

drainage basins) (Gustard, 1994), high-magnitude, low frequency events may dominate channel form and have lasting effects (Knighton, 1998).

As land managers, we desire to predict the conditions that will cause specific channel changes. Land use can affect the hydrologic cycle by reducing infiltration capacity, changing the amount and effectiveness of vegetation cover, changing the timing and volume of runoff, and changing channel bed roughness and thus water velocity in channels and in overland flows. These result in changes in the volume of storm runoff and peak discharge. Such changes may be expected to result from a variety of land-use alterations, such as urbanization, grazing, agriculture, forest removal, and others. Increases in the magnitude and frequency of flow and flood pulse events can translate into alterations in the channel morphology and pattern (see Channel Adjustment below). This is especially true for common flood events such as the effective discharge. While land use may change the magnitude and frequency of extreme flood events, data records are of insufficient length to correctly quantify these changes. However, data are sufficient to quantify changes in high frequency flood events such as the effective discharge, which may have the greatest effect on channel form.

Obvious flow regime alterations occur following urbanization (e.g., Hollis, 1975; Booth, 1990; Booth and Jackson, 1997). Impacts in forested regions have also been well studied but are a subject of much debate, especially regarding low frequency extreme events. However, it is clear that the removal of the forested canopy and/or the associated presence of a road network can alter water production. Annual water yield typically increases for some time following the reduction of vegetation cover (Bosch and Hewlett, 1982; Stednick, 1996). Furthermore, common peak flow events within the frequency range of the effective discharge of bedload (i.e., 0.5- to 2-year recurrence interval) increase following forest harvest and road building in small catchments (Jones and Grant, 1996; Thomas and Megahan, 1998; Lewis et al., 2001; Jones and Post, 2004). The cumulative effects of hydrologic alterations within large watersheds are relatively unknown and undocumented.

The same factors affecting surface runoff will also tend to change sediment load. Channel response to large sediment inputs depends on channel size, position of the receiving reach within the drainage network, the quantity and size of sediment, and the characteristics of the riparian zone (Hogan et al., 1998).

*Channel Adjustment:* Channels are constantly adjusting to changes in the timing and volume of flow and sediment, and to the characteristics and supply of wood. Channels can adjust to changes in the rate of flow, sediment, and wood through changes in channel geometry (width, depth, and slope), channel pattern, and bed texture (grain size and bed form). Table 1 summarizes the general response in channel geometry and pattern based on changes in sediment and/or stream flow and wood debris. The time scale of responses in the dependent factors to changes in independent factors is variable. Width and depth can respond to changes within a year, while adjustment in river slope and meander wavelength may take decades to centuries (Knighton, 1998). Whether the adjustment is small and incremental or episodic depends on the relative size or magnitude of the change.

Abrupt episodes of stream adjustment can occur as significant thresholds are crossed (e.g., Lisle, 1982). An event such as a large flood or disturbance can dramatically reshape the floodplain and increase channel width. Climate change (geologic time scale) or a change in watershed condition

by fire, timber harvest, grazing, urbanization, vegetative recovery, or direct channel manipulation (planning level time scale) may cause the river to change bed elevation either downward (degradation) or upward (aggradation). The stream will then build a new level of floodplain appropriate to the new bed elevation. These lateral and vertical adjustments in channel form over time, along with changes in channel pattern are called channel evolution.

Table 1. Generalized adjustment in stream geometry and pattern based on changes in flow and sediment discharge (modified from Kellerhals and Church, 1989, and Chang, 1988) and changes in large woody debris.

Changes in Independent Factors	Dependent or Adjustable Factors				
	Channel Geometry			Channel Pattern	
	Width <sub>1</sub>	Depth	Slope	Sinuosity	Meander Wavelength
Water discharge increases alone (e.g., forest harvest)	↑	↑	↓	↓	↑
Water discharge decreases alone (e.g., water supply diversion)	↓	↓	↑	↑	↓
Sediment discharge increases alone (e.g., road building on unstable slopes)	↑	↓	↓	↓	↑
Sediment discharge decreases alone (e.g., road & harvest restrictions)	↓	↑	↑	↑	↓
Water and sediment discharge both increase (e.g., response to large storm event)	↑	?	?	↓	↑
Water and sediment discharge both decrease (e.g., downstream of a reservoir)	↓	?	?	↑	↓
Water increases and sediment decreases (e.g., climate change toward a more humid pattern)	↑↓	↑	↓	↑	?
Water decreases and sediment increases (e.g., water supply diversion plus road building and harvest)	↑↓	?	↑	↓	?
Decreased large wood debris (e.g., riparian harvest)	↑↓	↑↓	↑	↓	↑
Increased large wood debris	↑↓	↑↓	↓	↑	↓

<sub>1</sub> Non-cohesive bank material (↑ = Increase; ↓ = Decrease; ↑↓ = Either increase or decrease or both; ? = Indeterminate)

Conceptual channel evolution models have been created to display typical channel adjustment following channel disturbance. Simon and Hupp (1986) developed a model for channel incision and vertical channel change (Figure 42). Once disturbed, a channel may proceed through a cycle of channel degradation and incision, bank failure and widening, aggradation, and re-creation of a floodplain and quasi-equilibrium channel form (Simon and Hupp, 1987, 1992 and Simon, 1994). Once disturbed, the channel bed and associated floodplain may or may not return to initial bed elevations. However, if disturbed, stream channels will tend to return approximately to their

previous state (e.g., pattern and size) once the perturbation is damped down (Knighton, 1984) (Figure 42).

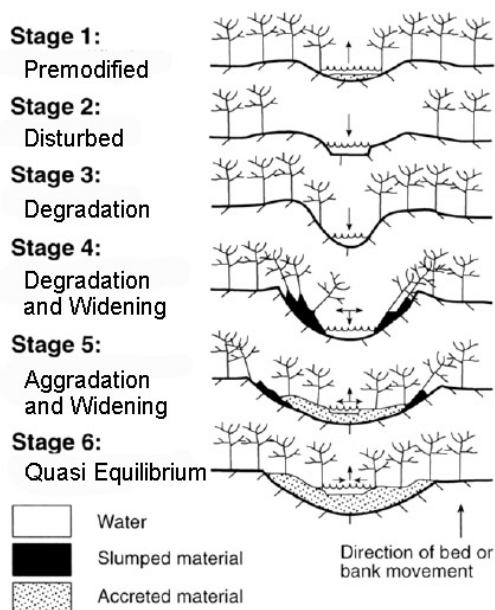


Figure 42. Channel incision and vertical channel change over time (Drawing: modified from Simon and Hupp 1986).

When a stream down-cuts or lowers its bed elevation (i.e., incision), the former floodplain it had been constructing may be abandoned. An abandoned floodplain is called a terrace. Terraces may be at different levels above the floodplain, depending on the past history of the individual river (Figure 43). When a river aggrades, the floodplain may reoccupy or become higher than adjacent terraces. The process of valley scour and redeposition is called “cut and fill.” Analysis of alluvial history suggests that valley filling tends to be a much slower process than valley erosion (Leopold, 1994). Many alluvial valleys consist of multiple floodplain and terrace surfaces.

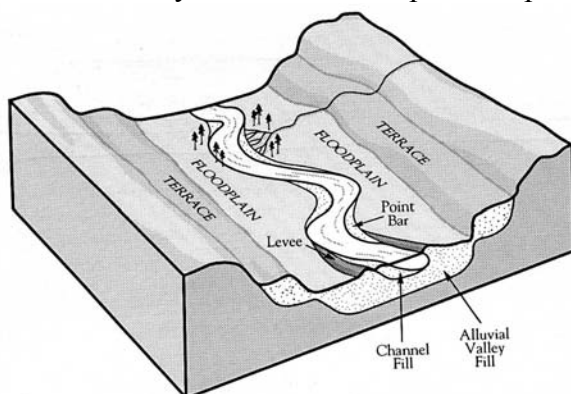


Figure 43. Cross section and planview illustration of terrace development and valley downcutting and subsequent filling (Drawing: adapted from Mount, 1995).

Terraces are susceptible to erosion by migrating channels, particularly when the terrace is composed of unconsolidated alluvium. Unlike the definition of floodplain, there is no

consistency among rivers in the recurrence interval of flooding of the terraces that exist (e.g., very extreme flood events) (adapted from Dunne and Leopold, 1978).

As with all natural systems, channels will develop the most stable configuration based on the existing conditions. However, rivers are inherently dynamic systems that constantly respond to variable inputs of water, wood, and sediment through erosion and deposition. For relatively constant conditions of the controlling variables, a natural river may develop characteristic forms, recognizable as statistical averages about which fluctuations occur. A change in discharge and sediment characteristics does not necessarily produce an immediate change in the stream channel but rather initiates a change that may extend over a period of time. Adjustment to changes in watershed conditions may take time and may not be completed before another event disrupts the condition, causing readjustment again. It is therefore not possible to forecast what will be the net effect of a particular or series of alterations. However, there are probable states (Leopold 1994).

*River pattern* is used to describe the planform geometry of a river reach or segment, as viewed from above as it would appear from an airplane, and implies the processes operating along that river. Channel pattern is used to define these characteristics only within individual channels that make up part of the overall river pattern (Nanson and Knighton, 1996). Two main river patterns are generally recognized: single-channel rivers and anabranching rivers. Anabranching rivers are multi-channel systems characterized by vegetative or otherwise stable alluvial floodplain islands that divide flows at discharges up to nearly bankfull (Schumm, 1985; Nanson and Knighton, 1996). Channel pattern, as applied to individual channels, has been classically divided into straight, meandering and braided channels (Leopold and Wolman, 1957). A simple diagram of these river and channel patterns is displayed in Figure 42, but more detailed analyses of different patterns also exist (Leopold and Wolman, 1957; Brice, 1978; Schumm, 1985; Knighton and Nanson, 1993; Nanson and Knighton, 1996; Thorne, 1998).

Due to hydrodynamics, nearly all natural channels exhibit some tendency to develop curves, or meanders in plan form, which seem to be proportional to the size of the channel. The meandering channel pattern is often illustrated as symmetrical bends, although the meanders can be asymmetrical or quite irregular. The exceptions to the meandering pattern occur where a stream is forced into a more or less straight channel pattern by land use intervention or through geologic controls like fractured bedrock or very cohesive sediment, and where high sediment loads produce a braided channel pattern. Even where the channel is straight it is usual for the thalweg, or line of maximum channel depth, to wander back and forth from near one bank to the other. Rivers are seldom straight through a distance greater than about ten channel widths, and so the designation straight is relative and implies an irregular, sinuous (non-meandering) alignment (Figure 44). Most rivers can also exhibit straight, meandering and braided patterns all within the same reach or valley segment depending on the scale of the observation.

A braided stream is divided into several channels that branch and rejoin around bare or sparsely vegetated sand/gravel/cobble bars. The braided form may range from occasional (widely separated single bars) to fully braided (many channels divided by many low bars). The braided channel pattern is partly stage or water level dependent. Bars exposed at most flows may be inundated at higher discharges to display the overall single-channel river pattern. Braided streams are characterized by high sediment load relative to transport capacity, wide active channels overall, low sinuosity, low threshold of bank erosion, rapid shifting of bed material, and a continuously shifting stream course (Knighton, 1998). Rapidly fluctuating stream flow contributes to bed instability and bank erosion, common on streams fed by glaciers. Braiding

involves the positive feedback cycle between sediment supply, bar formation, and bank erosion. Braided channels are also common in locations with a high sediment supply and a rapid reduction in transport capacity, such as alluvial fans when a steep mountain stream drops into a valley.

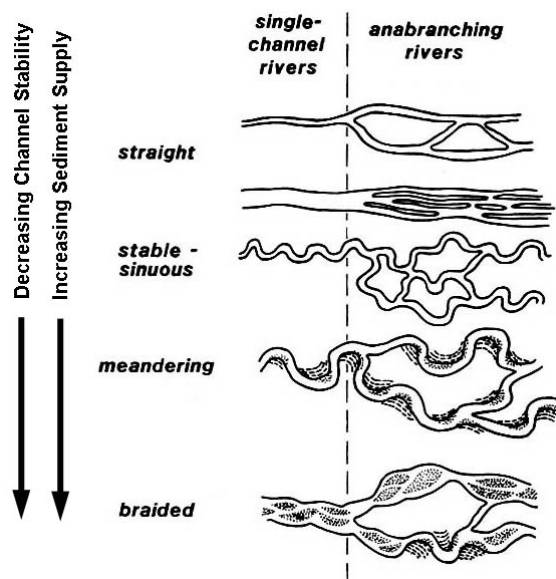


Figure 44. Single and Anabranching River Patterns (Drawing: modified from Nanson and Knighton, 1996)

Anabranching rivers have multiple channels divided by semi-permanent floodplain islands, which are typically vegetated. Individual channels within anabranching rivers can be straight, meandering or braided (Figure 44). Anabranching streams typically retain the appearance of a multiple channel system up to the bankfull discharge, when floodwaters connect across forested island floodplains. As with braided streams, individual channels of an anabranching river are a response to relatively high sediment supply at varying scales. Multiple channels, each with relatively small width-depth ratios as compared to the overall channel, effectively increase the sediment transport capacity to accommodate the sediment load (Schumm, 1985; Nanson and Knighton, 1996). Numerous types of anabranching rivers have been described (Part 2.5 Channel Types and Classifications). Wood debris also plays a role in initiating and sustaining anabranching systems (Abbe and Montgomery, 1996, 2003).

Anastomosing, a word borrowed from a medical term for dividing and rejoining blood vessels is used to describe a specific subset of anabranching rivers with erosion-resistant cohesive banks and relatively low width-depth ratios of individual channels. The lower width-depth ratios of anastomosing channels are partially supported by cohesive bank sediment, island vegetation root strength, and/or large woody debris bank protection (imbedded or instream) (Smith and Smith, 1984; Knighton and Nanson, 1993; Nanson and Knighton, 1996). As with all anabranching rivers, vegetation plays a crucial role in creating anastomosing channels by providing bank cohesion and providing wood debris for channel creation (i.e., avulsion), maintenance, and stability (Nanson and Knighton, 1996; Gurnell and Petts, 2002; Abbe & Montgomery, 2003).

Channel pattern represents a mode of channel form adjustment in the horizontal plane that is linked with other channel adjustments. The available evidence suggests that the sequence of straight, meandering and braided patterns is related to (Knighton, 1984):



- increasing width-depth ratio, which is generally associated with decreasing bank stability/resistance and increasing bed-load transport;
- increasing stream power, which implies increasing discharge at constant slope or increasing slope at constant discharge; and
- increasing sediment load and in particular bed load.

A particular channel shape and pattern is closely related to the quantity and variability of stream flow, the quantity and character of the sediment and wood in movement through the section, and the composition of the materials making up the bed and banks of the channel. Classifying channels based on pattern can tell us something about the current sediment and water regime, but a channel pattern can change from a large change in either of those inputs. For example, a channel may change from a single channel meandering pattern to a braided pattern and back to a meandering pattern in response to a large but temporary increase in sediment or short term reduction of bank resistance through vegetation loss. It is not uncommon for a non-braided channel to develop a side channel forced by the deposition of large wood at the upstream end of a gravel bar. A channel can also be highly sinuous and meandering but entirely confined by bedrock or very cohesive banks.

River pattern is a continuum from one extreme to another. There is no sharp distinction between any of these patterns, but empirical attempts have been made to separate them (Leopold et al. 1964). The current pattern of the channel is only one attribute looked at when attempting to predict future channel movement. Because plan form is a response to a complex array of interactive variables, it is not the sole discriminator for river classification or channel types. Although any classification of distinctive patterns or channel types is somewhat arbitrary, some sweeping statements can be made about the processes forming each general class. These generalities are expanded upon below.

*Channel Types and Classification:* Because a river channel can be characterized by a particular combination of patterns and attributes, channel classification is possible. Once classified, general statements can be made about the responsiveness of each channel type to changes in the controlling factors described above. Based on a combination of characteristics, we can broadly predict which stream channels will have a tendency to migrate over time and by what processes. However, river channel morphologies do not always neatly fit into discrete compartmental types. Rivers should be viewed as a continuum (or discontinuum) of channel types, where one type blends gradually or abruptly into another depending on different processes and geomorphic thresholds (Kondolf et al., 2003).

A number of classification schemes exist in the literature and are applied at different scales for different purposes. Defining the intended spatial scale of any classification scheme is important. Streams can be viewed as hierarchically organized, interlocked units nested within each other. The variability of the next lower level is constrained by the higher hierarchical level (Frissell et al., 1986; Kondolf et al., 2003). These hierarchical levels range from the river system or catchment scale, to the valley segment scale, to the reach scale, to the habitat scale, to the microhabitat scale (Figure 45) (Frissell et al., 1986). For the purposes of channel migration, the valley segment and reach scales are most appropriate. Fortunately, the majority of channel classification systems have focused at these scales.

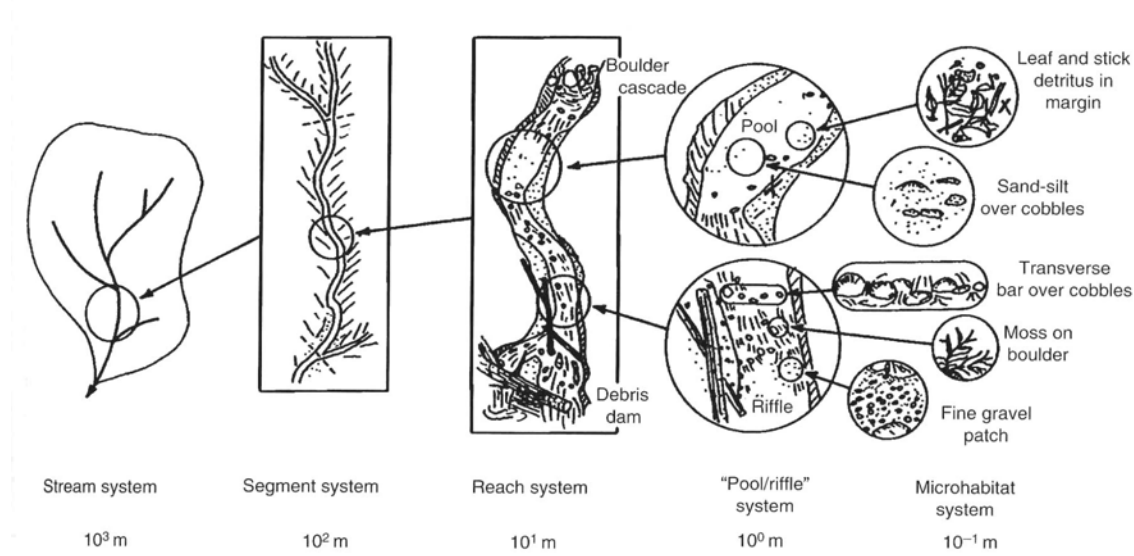


Figure 45. Hierarchical stream classification (Drawing: Frissell et al., 1986; adapted from Kondolf et al., 2003).

Several basic catchment-to-reach scale classifications of fluvial forms and processes have been reviewed above [i.e., 1) sediment erosion, transfer, and long-term storage zones (Schumm, 1977); 2) bedrock, semi-controlled, and alluvial channels (Schumm, 1985); 3) single-channel rivers and anabranching rivers (Nanson and Knighton, 1996); 5) straight, meandering and braided channels (Leopold and Wolman, 1957)]. While very useful, these classifications are only a few building blocks of more detailed reach and segment scale classifications.

All channel classifications use a combination of attributes to describe general channel types. Basic to many of these are 1) channel slope or gradient, 2) horizontal and vertical confinement of the channel (valley morphology), 3) relative channel size (function of drainage area and dominant discharge), 4) bank and bed material and size, 5) dominant mode of sediment transport, 6) channel pattern, 7) and available stream energy (stream power).

Several mountain drainage basin classifications exist for Washington state. Whiting and Bradley (1993) classify headwater channels based on process interactions between hillslopes and channels. Montgomery and Buffington (1993, 1997) use a process-based channel classification that relates morphological parameters to relative sediment supply and the ratio of sediment supply to transport capacity. While very useful for many streams in a mountain drainage network, these classifications are limited in their applicability to floodplain river systems and the assessment of migration potential through floodplain deposits.

Cupp (1989) developed a valley segment scale classification intended for basin-wide land management planning and research. Cupp's system focuses on six valley bottom and sideslope geomorphic characteristics thought to remain relatively persistent over a planning time scale. Grouped into four broad categories, any valley width to channel width ratio greater than 2 is generally considered "unconstrained" in this system. This type of classification can provide a relative measure of the valley size potentially available to channel migration.

Nanson and Croke (1992) give a genetic classification specific to floodplain morphology and functional processes in alluvial rivers. Their classification is based on a stream's competence and ability to do work. Primary classification variables include specific stream power and the erosional resistance of floodplain alluvium. *Specific stream power* is the potential energy per unit width of stream available to erode and transport sediment. It is a function of stream slope, discharge and channel width. The classification scheme is divided into three major distinct groups based mainly on stream power and sediment size. Sediment size of non-cohesive alluvium ranges from gravel to fine sand, while cohesive alluvium consists of silt and clay.

Class A: High-Energy Non-Cohesive Floodplains

Class B: Medium-Energy Non-Cohesive Floodplains

Class C: Low-Energy Cohesive Floodplains

Within this classification are a total of fifteen subgroups that differ according to specific stream power, sediment size, confinement, erosional and depositional or accretional processes, landforms, channel pattern, and catchment location.

Nanson and Knighton (1996) provide a classification of floodplain anabranching rivers, which are very common in Washington State. Again, their classification is primarily based on stream power (slope-discharge combinations) but also includes classification metrics on bed and bank material size, lateral migration rate, vertical accretion rate, channel sinuosity, and relative floodplain island size. They distinguish six different channel types, within which there are also several sub-types (Figure 46).

Channel type	Channel character	Unit stream power	Bed material	Bank material	Lateral migration rate	Vertical accretion rate	Channel sinuosity	Island length/channel width
1	Anastomosing	A	A	A	A	A	E	F
2	Sand-dominated, island forming	B	B	B	B	F	A	E
3	Mixed load, laterally active	C	C	C	C = /F =	C =	F	D
4	Sand-dominated, ridge forming	D	D	D	C = /D	B	B	C
5	Gravel-dominated, laterally active	E	E	E	F	C =	D	B
6	Gravel-dominated, stable	F	F	F	E/C =	E	C	A

A-F: relative strength of variable, either LOW (A) to HIGH (F) or FINE (A) to COARSE (F).

*Figure 46. Summary of variables linked to channel adjustment, morphology and classification in floodplain alluvial rivers (Chart: Nanson and Knighton, 1996; after Gurnell and Petts, 2002).*

These two process-based, floodplain classification systems (i.e., Nanson and Croke 1992; Nanson and Knighton 1996) can be utilized separately or in combination, due to their overlapping attributes. Once classified by these variables, a channel can be assessed for the dominant processes operating to build and erode floodplain deposits and its relative potential to migrate and rework these deposits.

Channel classification is useful for identifying or screening for channels prone to migration and, if assessed correctly, will provide clues to the generalized processes operating within a stream reach or segment. It also provides a technical basis for communication regarding river systems. However, the existing classification systems were not designed to predict delineation lines of channel migration zones on the ground. The dynamic behavior of channels through space and time at a unique location along the river discontinuum cannot be fully captured by channel classification, as it is not an absolute predictive tool.

## 2.6 Summary

The technical information provided in this background serves as a common language to describe and analyze streams prone to channel migration. While detailed scientific quantification of channel form and process is always possible, in most cases it is not necessary to proceed to this level of detail to generally understand a stream system or delineate a channel migration zone. However, at least a qualitative understanding of forms and processes at work in a given stream reach or segment is essential to guide a CMZ delineator in their attempt to predict future channel locations. This essential understanding of a river system, as defined above, includes: 1) the watershed's landscape location (e.g., climate, geology, land use); 2) segment location in the river discontinuum (e.g., upland valley vs. lowland valley); 3) valley segment four-dimensional configuration (e.g., confined vs. unconfined); 4) general magnitude and frequency of water, sediment and wood inputs and their disturbance effects; 5) floodplain building processes (e.g., combination of avulsion and bank erosion); 6) river pattern and plan form (e.g., inferences of fluvial processes at work); 7) cycles of channel adjustment and evolution through time (e.g., relative changes in bed elevation or channel pattern); and 8) an appreciation of the complex interaction of all these forms and processes over time.

Stream classification systems attempt to incorporate some or all of these variables to describe the responsiveness of a given stream to changes in the controlling factors and predict a stream's tendency to migrate over time. Once a stream is classified and at least qualitatively understood, communication regarding management options will be greatly enhanced.

## 2.7 Glossary

As used in Part 2, the following terms are defined as:

**abandoned channel:** Any *channel* feature that was once more active in water and sediment transport than in its current form. Often partially filled in or blocked at the upstream end with sediment, duff, or debris. No reference to time or location. Could be formed from active and recent processes or processes and conditions no longer operating and masked by sediment and organic material infilling. Can either be on a terrace or floodplain.

**active channel:** That portion of the channel or floodplain network that receives periodic scour and/or fill during sediment transport events.

**aggradation:** An increase in sediment supply and/or decrease in sediment transport capacity that leads to an increase in the channel bed elevation. An increase in base level can also decrease sediment transport capacity, thereby initiating aggradation.

**alluvial fan:** A cone or fan-shaped deposit of sediment and debris that accumulate immediately below a significant change in channel gradient and/or valley confinement. Viewed from above, it has the shape of an open fan, the apex being at the valley mouth.

**alluvium / alluvial:** A general term for or pertaining to deposits made by streams on river beds, flood plains, and alluvial fans.

**anabranch:** A diverging branch or *secondary channel* of a river, which reenters the mainstream some distance downstream.

**anabranching:** A river pattern with multi-channels characterized by vegetative or otherwise stable alluvial *floodplain islands* that divide flows at discharges up to nearly bankfull. Individual channels may be straight, meandering or braided.

**anastomosing channel:** A river pattern (subset of anabranching) with multiple, interconnected, coexisting channels separated by *floodplain islands*, with erosion-resistant cohesive banks, and relatively low width-depth ratios of individual channels.

**avulsion:** Relatively sudden and major shifts in the position of the channel to a new part of the floodplain (first-order avulsion) or sudden reoccupation of an old channel on the floodplain (second-order avulsion) or relatively minor switching of channels within a braid train or other active channels (third-order avulsion) (Nanson and Knighton 1996).

**avulsion hazard zone (AHZ):** The area not included in the HMZ where the channel is prone to move by avulsion and if not protected would result in a potential near-term loss of riparian function and associated habitat adjacent to the stream.

**bankfull stage:** The height at which the channel overflows its banks, corresponding approximately to the discharge at which the channel characteristics are maintained.

**braided :** a channel pattern that is divided into several channels that branch and rejoin around bare or sparsely vegetated sand/gravel/cobble bars.

**channel (watercourse):** Any open conduit or linear depressional feature either naturally or artificially created or cut by fluvial processes (i.e., erosion plus deposition), which periodically or continuously (i.e., intermittent or perennial) contains moving water, or which forms a connecting link between two bodies of water.

**channel evolution:** Lateral and vertical adjustments in channel form over time, along with changes in *channel pattern*.

**channel pattern:** The planform geometry of a river channel, as viewed from above as it would appear from an airplane. Only used to describe individual channels that make up part of the overall *river pattern*.

**chutes:** Small *secondary channels* used during flow or flood pulses only. Typically chutes flow across the convex side of meander bends through floodplain deposits, between sequential riffles above and below meander bends, and along steeper flow paths than the main river channel.

**chute cutoff:** A reach scale *avulsion* that erodes a channel behind a point bar deposit either through a *chute* (second-order *avulsion*) or the general floodplain (first-order *avulsion*).

**confinement or valley confinement:** A measure of the degree to which a channel is bounded by hillslopes or other resistant landform, usually expressed as a ratio of the average channel width to valley bottom width.

**debris flow:** A moving mass of rock fragments, soil, and mud, more than half of the particles being larger than sand size.

**degradation:** An decrease in sediment supply and/or increase in sediment transport capacity that leads to an decrease in the channel bed elevation through incision or downcutting. A decrease in base level can also increase sediment transport capacity, thereby initiating degradation or incision.

**dike or levee (constructed):** A continuous structure from valley wall to valley wall or other geomorphic feature that acts as an historic or ultimate limit to lateral channel movements and is constructed to a continuous elevation exceeding the 100-year flood stage (1% exceedence flow); or a structure that supports a public right-of-way or conveyance route and receives regular maintenance sufficient to maintain structural integrity.

**disconnected migration area (DMA):** The portion of the CMZ behind a permanently maintained dike or levee.

**distributary channel:** A *secondary channel* that branches from the main channel but does not rejoin. These typically occur at the mouth or delta of a river where it empties in a lake or ocean or on an alluvial fan.

**entrenchment:** The vertical containment of a river and the degree to which it is incised within a valley floor, as seen by the relationship between the channel and the relatively flat surfaces on the valley floor that may be prone to flooding at some maximum stream discharge

**erosion hazard area (EHA):** Those areas outside of the HMZ and AHZ which are susceptible to bank erosion and retreat from stream flow and this can result in a potential near-term loss of riparian function and associated habitat adjacent to the stream

**flood frequency:** Refers to a flood level that has a specified percent chance of being equaled or exceeded in any given year. For example, a 100-year flood occurs on average once every 100 years and thus has a 1-percent chance of occurring in a given year.

(Recurrence Interval: the average time interval in years in which a flow of a given magnitude will recur)

**floodplain:** The relatively flat area or berm adjoining a river channel and constructed by the river in the present climate by a combination of progressive lateral migration, channel creation and abandonment, and overbank sediment deposition from periodic inundation. Floodplains may not be uniform or homogeneous flat surfaces, and can consist of irregular or multiple surfaces at different elevations that reflect vertical differences in the channel bed resulting from local scour, changes in flow regime, sediment supply and wood loading. See complete definition in Part 2.2 Determining if Channel Migration Is Present

**floodplain island:** A body of land located within the active river channel completely surrounded by water during moderate flow or flood pulses, which can be completely inundated during larger floods.

**flood-prone width:** the width of the stream at some maximum stream discharge.

**gradient:** The slope of the stream channel, valley, floodplain, or terrace in the downstream direction usually expressed as a ratio of vertical rise to horizontal run. Channel gradient can either be measured as the thalweg slope or water surface slope.

**historic migration zone (HMZ):** The sum of all active channels over the historical period that usually includes the time between the year 1900 and the present – the approximate time period sufficient to capture pre-timber harvest channel conditions. This time period is extended for those sites known to have been impacted by timber harvest activities prior to 1900, or where historical information such as Government Land Office maps and notes are available.

**lahar:** A mixture of water and rock debris (mudflow) composed chiefly of pyroclastic material on the flanks of a volcano.

**lateral erosion:** The wearing down or washing away of the stream bank, soil and land surface by the action of water as the stream swings from side to side, impinging against and undercutting its banks.

**levee (natural):** A longitudinal (flood) berm of sediment along the channel bank. Results from sediment (silt to boulder) deposition dropped from suspension or movement during floods. Occurs where water passes from a deep channel to shallow flow and where turbulence abruptly drops along channel margins.

**main channel:** The main stream channel is the dominant channel with the deepest or lowest thalweg, the widest width within defined banks, and the most water during low flow periods. Main channel locations can be transient over time. Braided channels may not have a defined main channel, especially as stages reach bankfull.

**meandering:** a channel pattern of stream curves in plan form (symmetrical bends, asymmetrical or irregular), which seem to be proportional to the size of the channel. Meandering is a pattern and does not necessarily imply bank erosional processes at work in the channel.

**meander belt:** The area between the limits of the amplitude of the meander bends. Typically, parallel lines are drawn to encompass the maximum amplitude of the meander wave and any meander cutoffs or oxbow lakes in a given stretch of river. Multiple sets of parallel lines are usually drawn to encompass meander belts along sinuous valleys.

**meander scrolls:** Individual *ridge-swale* pairs oriented in a curvilinear fashion along the convex side of meander bends.

**neck cutoff:** A reach scale *avulsion* that erodes a channel through a floodplain deposit (first- or second-order *avulsion*) connecting two previously separated meander bends.

**overflow channel:** A *secondary channel* on the floodplain that conveys water away from and/or back into the main channel. These channels can be continuous or interrupted in space in terms of channel dimensions and scour and fill. They often are a response to episodic flood scour and fill during floodplain inundation and drainage. They also can partially fill in between episodic flood events or become *abandoned* completely or be blocked by deposits of sediment or wood at their head. Overflow channels are typically at or above the range of bankfull flow elevations.

**oxbow lake:** A crescent shaped pond or lake formed in a portion of abandoned stream channel cut off from the rest of the main channel created when meanders are cut off by *avulsions* from the rest of the channel. Once isolated by formation of avulsion channels, oxbow lakes will slowly fill up with sediment, as point bar sands and gravels are buried by silts, clays, and organic material carried in by river floods and by sediment slumping in from sides as rain fills up lake.

**point bar:** Accumulations of fluvial sediment at the relatively gentle slope of the inside of a *channel* bend or curve.

**river pattern:** the planform geometry of a river reach or segment, as viewed from above as it would appear from an airplane, and implies the processes operating along that river. The river pattern includes the individual channels patterns within the reach or segment.

**secondary channel:** Any *channel* on or in a floodplain that carries water (intermittently or perennially in time; continuously or interrupted in space) away from, away from and back into, or along the main channel. Secondary channels include: *side channels, wall-based channels, distributary channels, anabranch channels, abandoned channels, overflow channels, chutes, and swales.*

**segment or channel segment:** Lengths of stream that have similar valley confinement, discharge, channel pattern, and average valley gradient.

**side channel:** A *secondary or anabranch channel* that is at least partially connected to the main river channel with its channel thalweg at or below the range of bankfull flow elevations. Side channel inlets are often blocked by wood jams or large accumulations of gravel and sand.

**sinuosity:** A measure of the extent of river meandering usually applied to single channels and expressed as the ratio of channel thalweg length to straight-line valley length.

**slough:** An area of slack (not moving) water formed in a *meander scroll* deposit (*swale*) or an *abandoned channel* still partially connected to the main river at its downstream end. During flood stage, sloughs can become reconnected at their upstream end.

**straight:** a channel pattern in plan form where a stream is forced into a more or less non-curved channel pattern by land use intervention or through geologic controls like fractured bedrock or very cohesive sediment.

**specific stream power:** the potential energy per unit width of stream available to erode and transport sediment.

**surface or floodplain surface:** A constant feature up and down the valley that lies at a relatively consistent elevation above bankfull and was formed by a discrete process at a discrete point in time, resulting in consistent soil development and other age indicators. See Part 2.3 under Channel Migration Zone Components.

**swales:** Small *secondary channel* or linear depressional features on point bar deposits. Associated with the point bar are a series of arcuate *ridges* and *swales*. The *ridges* are formed by lateral channel movement and are relic lateral bars separated by low-lying *swales*. *Swales* are locations where fine-grained sediments accumulate following original creation. See Figure 37 in background section.

**terrace:** A former or relict floodplain no longer inundated by flood water given the current climate. See complete definition in Part 2.2 Determining if Channel Migration Is Present

**thalweg:** The longitudinal line that defines the deepest part of the channel or stream bed.

**underfit stream:** A river or stream that appears too small to have eroded the valley in which it occupies.

**wall-based channel:** A *secondary channel* formed on floodplains or terraces that follows linear depressional features created by channel migration or floodplain deposition of the mainstem river near the base of valley walls or terraces. They typically flow parallel to a mainstem river along the floodplain before joining the river. These channels can be *anabranched* or *secondary channels* of the main river, or tributary channels. Water sources can originate from a combination of hillslope tributary input, hillslope seepage, groundwater input (i.e., springs or diffuse), river water input, and direct local precipitation.

## 2.8 References

- Abbe, T.B.** 2000. Patterns, mechanics and geomorphic effects of wood debris accumulations in a forest river system. University of Washington, PhD Dissertation, Seattle, WA.
- Abbe, T.B., Brooks, A.P., and Montgomery, D.R.** 2003. Wood in River Rehabilitation and Management . *In The Ecology and Management of Wood in World Rivers. Edited by S.V. Gregory, K.L. Boyer, and A.M. Gurnell.* American Fisheries Society , Bethesda, MD.
- Abbe, T.B. and Montgomery, D.R.** 1996. Large Woody Debris Jams, Channel Hydraulics and Habitat Formation in Large Rivers. *Regulated Rivers: Research and Management* **12**: 201-221.
- Abbe, T.B. and Montgomery, D.R.** 2003. Patterns and Processes of Wood Debris Accumulation in the Queets River Basin, Washington. *Geomorphology* **51**: 81-107.
- Booth, D.B.** 1990. Stream-Channel Incision Following Drainage-Basin Urbanization. *Water Resources Bulletin* **26**: 407-417.
- Booth, D.B., Haugerud, R.A., and Troost, K.G.** 2003 The Geology of Puget Lowland Rivers. *In Restoration of Puget Sound Rivers. Edited by D.R. Montgomery, S.M. Bolton, D. Booth, and L. Wall.* University of Washington Press, Seattle, WA pp. 14-45.
- Booth, D.B. and Jackson, C.R.** 1997. Urbanization of Aquatic Systems: Degradation Thresholds, Stormwater Detection, and the Limits of Mitigation. *Journal of the American Water Resources Association* **33**: 1077-1089.
- Bosch, J.M. and Hewlett, J.D.** 1982. A Review of Catchment Experiments to Determine the Effect of Vegetation Changes on Water Yield and Evapotranspiration. *Journal of Hydrology* **55**: 3-23.
- Brice, J.C., Blodgett, J.C., and et al.** 1978. Countermeasures for Hydraulic Problems at Bridges,



- Volume 1 and 2. Federal Highway Administration Report FHWA-RD-78-163, Washington D.C.
- Bridge**, J.S. 2003. Rivers and Floodplains: Forms, Processes, and Sedimentary Record. Blackwell, Oxford, UK.
- Brooks**, A.P. , Brierley, G.J., and Millar, R.G. 2003. The Long-term Control of Vegetation and Woody Debris on Channel and Flood-plain Evolution: Insights from a Paired Catchment Study in Southeastern Australia. *Geomorphology* **51**: 7-29.
- Chang**, H.H. 1988. Fluvial Processes in River Engineering. John Wiley and Sons, New York.
- Church**, M. 2002. Geomorphic Thresholds in Riverine Landscapes. *Freshwater Biology* **47**: 541-557.
- Collins**, B.D., Montgomery, D.R., and Sheikh, A.J. 2003. Reconstructing the Historical Riverine Landscape of the Puget Lowland. *In Restoration of Puget Sound Rivers. Edited by D.R. Montgomery, S.M. Bolton, D. Booth, and L. Wall.* University of Washington Press, Seattle, WA pp. 79-128.
- Cupp**, C.E. 1989. Stream Corridor Classification for Forested Lands of Washington. State of Washington, Timber/Fish/Wildlife, Ambient Monitoring Program, Olympia, WA.
- Dunne**, T. and Leopold, L.B. 1978. Water in Environmental Planning. W.H. Freeman, San Francisco.
- Frissell**, C.A., Liss, W.J., Warren, C.E., and Hurley, M.D. 1986. A Hierarchical Framework for Stream Habitat Classification: Viewing Stream in a Watershed Context. *Environmental Management* **10**: 199-214.
- Galay**, V.J., Kellerhals, R., and Bray, D.I. 1973. Diversity of River Types in Canada. *In Fluvial Processes and Sedimentation. Edited by Proceedings of Hydrology Symposium.* National Research Council of Canada, pp. 217-250.
- Gippel**, C.J. , O'Neill, I.C., Finlayson, B.L., and Schnatz, I. 1996. Hydraulic Guidelines for the ReIntroduction and Management of Large Woody Debris in Lowland River Systems. *Regulated Rivers Research and Management* **12**: 223-236.
- Gurnell**, A.M. and Petts, G.E. 2002. Island-Dominated Landscapes of Large Floodplain Rivers: a European Perspective. *Freshwater Biology* **47**: 581-600.
- Gustard**, A. 1994. Analysis of River Regimes. *In The Rivers Handbook: Hydrological and Ecological Principles; Volume One and Two . Edited by P. Calow and G.E. Petts.* Blackwell Scientific Publications, Oxford, United Kingdom pp. 29-47.
- Hogan**, D.L., Bird, S.A., and Rice, S.P. 1998. Stream Channel Morphology and Recovery Processes. *In Carnation Creek and Queen Charlotte Islands Fish/Forestry: Applying 20 Years of Coastal Research and Management Solutions. Edited by D.L. Hogan, P.J. Tschaplinski, and S. Chatwin.* B.C. Ministry of Forests, Land Management Handbook No. 41, Victoria B.C. pp. 77-96.
- Hollis**, G.E. 1975. The Effects of Urbanization on Floods of Different Recurrence Interval. *Water Resources Research* **11**: 431-435.
- Jones**, J.A. and Grant, G.E. 1996. Peak Flow Responses to Clear-Cutting and Roads in Small and Large Basins, Western Cascades, Oregon. *Water Resources Research* **32**: 959-974.

- Jones, J.A.** and Post, D.A. 2004. Seasonal and Successional Streamflow Response to Forest Cutting and Regrowth in the Northwest and Eastern United States. *Water Resources Research* **40**: WO5203.
- Jones, L.S.** and Schumm, S.A. 1999. Causes of Avulsion: An Overview. *In* *Fluvial Sedimentology VI Edited by N.D. Smith and J. Rogers*. International Association of Sedimentologists, Special Publication 28, Blackwell Science, Oxford, U.K. pp. 171-178.
- Kellerhals, R.** and Church, M. The Morphology of Large Rivers: Characterization and Management. Dodge, D. P. The International Large River Symposium. 89.
- Kellerhals, R.,** Neill, C.R., and Bray, D.I. 1972. Hydraulic and Geomorphic Characteristics of Rivers in Alberta. Research Council of Alberta, River Engineering and Surface Hydrology Report 72-1.
- Knighton, A.D.** and Nanson, G.C. 1993. Anastomosis and the Continuum of Channel Pattern *Earth Surface Processes and Landforms* **18**: 613-625.
- Knighton, D.** 1999. Downstream Variation in Stream Power. *Geomorphology* **29**: 293-306.
- Knighton, D.** 1984. *Fluvial Forms and Processes* Arnold, London.
- Knighton, D.** 1998. *Fluvial Forms and Processes: A New Perspective*. Arnold, London.
- Kondolf, G.M.,** Montgomery, D.R., Piegay, H., and Schmitt, L. 2003. Geomorphic Classifications of Rivers and Streams. *In* *Tools in Fluvial Geomorphology. Edited by G.M. Kondolf and H. Piegay*. John Wiley and Sons, West Sussex, U.K. pp. 171-204.
- Lancaster, S.T.,** Hayes, S.K., and Grant, G.E. 2001. Modeling Sediment and Wood Storage and Dynamics in Small Mountainous Watersheds. *In* *Geomorphic Processes and Riverine Habitat. Edited by J.M. Dorava, D.R. Montgomery, B.B. Palcsak, and F.A. Fitzpatrick*. American Geophysical Union, Water Science and Application 4, Washington D.C. pp. 85-102.
- Leopold, L.B.** 1994. *A View of a River*. Harvard University Press.
- Leopold, L.B.** and Wolman, M.G. 1957. River Channel Patterns: Braided, Meandering and Straight. United States Geological Survey Professional Paper 282B.
- Leopold, L.B.,** Wolman, M.G., and Miller, J.P. 1964. *Fluvial Processes in Geomorphology*. Dover, New York.
- Lewis, G.W.** and Lewin, J. 1983. Alluvial Cut-offs in Wales and the Borderlands. *In* *Modern and Ancient Fluvial Systems. Edited by J.D. Collinson and J. Lewin*. Blackwell, Special Publication of the International Association of Sedimentologists, Oxford, United Kingdom pp. 145-154.
- Lewis, J.,** Mori, S.R., Keppeler, E.T., and Ziemer, R.R. 2001. Impacts of Logging on Storm Peak Flows, Flow Volumes and Suspended Sediment Loads in Casper Creek, California. *In* *Land Use and Watersheds: Human Influences on Hydrology and Geomorphology in Urban and Forest Areas. Edited by M.S. Wigmosta and S.J. Burges*. American Geophysical Union, Water Science and Application 2, Washington D.C. pp. 85-125.
- Lisle, T.E.** 1982. Effects of Aggradation and Degradation on Riffle-Pool Morphology in Natural Gravel Channels, Northwestern California. *Water Resources Research* **18**: 1643-1651.
- Lisle, T.E.** 1995. Effects of Coarse Woody Debris and Its Removal on a Channel Affected by the 1980 Eruption of Mount St. Helens, Washington. *Water Resources Research* **31**: 1797-1808.

- Lisle**, T.E. and Napolitano, M.B. 1998. Effects of Recent Logging on the Main Channel of North Fork Caspar Creek. *In Proceedings of the Conference on Coastal Watersheds: The Caspar Creek Story. Edited by R.R. Ziemer.* U.S.D.A., Pacific Southwest Research Station, Forest Service.
- Mackin**, J.H. 1948. Concept of the Graded River . University of Washington, Seattle, WA.
- Maser**, C. and Sedell, J.R. 1994. From the Forest to the Sea: The Ecology of Wood in Streams, Rivers, Estuaries and Oceans. St. Lucie Press , Delray Beach, FL.
- Massong**, T.M. and Montgomery, D.R. 2000. Influence of Sediment Supply, Lithology, and Wood Debris on the Distribution of Bedrock and Alluvial Channels. *Bulletin of the Geological Society of America* **112**.
- Montgomery**, D.R. 1999. Process Domains and the River Continuum. *Journal of the American Water Resources Association* **35**: 397-410.
- Montgomery**, D.R., Abbe, T.B., Buffington, J.M., Peterson, N.P., Schmidt, K.M., and Stock, J.D. 1996. Distribution of Bedrock and Alluvial Channels in Forested Mountain Drainage Basins. *Nature* **381**: 587-589.
- Montgomery**, D.R. and Buffington, J.M. 1993. Channel classification, prediction of channel response, and assessment of channel condition. Timber/Fish/Wildlife Report TFW-SH10-93-002, Seattle, WA.
- Montgomery**, D.R. and Buffington, J.M. 1997. Channel-Reach Morphology in Mountain Drainage Basins. *Geological Society of America Bulletin* **109**: 596-611.
- Mount**, J.F. 1995. California Rivers and Streams. University of California Press, Berkeley, CA.
- Nanson**, G.C. and Croke, J.C. 1992. A Genetic Classification of Floodplains. *Geomorphology* **4**: 459-486.
- Nanson**, G.C. and Knighton, A.D. 1996. Anabranching Rivers: Their Cause, Character and Classification. *Earth Surface Processes and Landforms* **21**: 217-239.
- National Research Council** 1996. Alluvial Fan Flooding. National Academy Press, Washington D.C.
- O'Connor**, J.E., Jones, M.A., and Haluska, T.L. 2003. Flood Plain and Channel Dynamics of the Quinault and Queets Rivers, Washington, USA. *Geomorphology* **51**: 31-59.
- Poff**, N.L., Allan, J.D., Bain, M.B., Karr, J.R., Prestegard, K.L., Richter, B.D., Sparks, R.E., and Stromberg, J.C. 1997. The Natural Flow Regime: A Paradigm for River Conservation and Restoration . *BioScience* **47**: 769-784.
- Poole**, G.C. 2002. Fluvial Landscape Ecology: Addressing Uniqueness within the River Discontinuum. *Freshwater Biology* **47**: 641-660.
- Rapp**, C.F., and Abbe, T.B. 2003. A Framework for Delineating Channel Migration Zones. Washington State Department of Ecology and Washington State Dept. of Transportation; Ecology Final Draft Publication #03-06-027.
- Rice**, S. and Church, M. 1998. Grain Size Along Two Gravel-bed Rivers: Statistical Variation, Spatial Pattern and Sedimentary links. *Earth Surface Processes and Landforms* **23**: 345-363.
- Rosgen**, D.L. 1994. A Classification of Natural Rivers . *Catena* **22**: 169-199.

- Schumm**, S.A. 1977. *The Fluvial System*. Wiley-Interscience, New York.
- Schumm**, S.A. 1985. Patterns of alluvial rivers *Annual Review of Earth and Planetary Science* **13**: 5-27.
- Sedell**, J.R. and Luchessa, K.J. 1982. Using the Historical Record as an Aid to Salmonid Habitat Enhancement. *In Acquisition and Utilization of Aquatic Habitat Inventory Information: Symposium Proceedings. Edited by N.B. Armantrout*. The Hague Publishing, Billings, MT pp. 210-223.
- Shields**, F.D.Jr. and Gippel, C.J. 1995. Prediction of Effects of Woody Debris Removal on Flow Resistance. *Journal of Hydraulic Engineering* **121**.
- Sidle**, R.C., Pearce, A.J., and O'Loughlin, C.L. 1985. Hillslope stability and land use. *American Geophysicists Union Water Resources Monograph #11*.
- Simon**, A. 1994. Gradation processes and channel evolution in modified west Tennessee streams process, response, and form. USGS, Denver, CO.
- Simon**, A. and Hupp, C.R. 1986. Channel Widening Characteristics and Bank Slope Development along a Reach of Cane Creek, West Tennessee. USGS Water-Supply Paper 2290. Denver, CO.
- Simon**, A. and Hupp, C.R. 1992. Geomorphic and Vegetative Recovery Processes Along Modified Stream Channels of West Tennessee. USGS; Open-File Report 91-502, Denver, CO
- Simon**, A. and Hupp, C.R. 1987. Geomorphic and Vegetative Recovery Processes along Modified Tennessee Streams: An Interdisciplinary Approach to Disturbed Fluvial Systems. *In Forest Hydrology and Watershed Management. Edited by International Association of Hydrological Sciences*. International Association of Hydrological Sciences, Washington, DC.
- Smith**, D.G. and Smith, N.D. 1980. Sedimentation in Anastomosed River Systems: Examples from Alluvial Valleys Near Banff, Alberta. *Journal of Sedimentary Petrology* **50**: 157-164.
- Stednick**, J.D. 1996. Monitoring the Effects of Timber Harvest on Annual Water Yield. *Journal of Hydrology* **176**: 79-95.
- Sullivan**, K., Lisle, T.E., Dolloff, C.A., Grant, G.E., and L.M. Reid, L.M. 1987. Stream channels: The link between forests and fishes. *In Streamside Management: Forestry and Fisheries Interactions. Edited by E.O. Salo and T.W. Cundy*. Institute of Forest Resources Contribution, No. 57, University of Washington, Seattle, Washington pp. 39-97.
- Thomas**, R.B. and Megahan, W.F. 1998. Peak Flow Responses to Clear-Cutting and Roads in Small and Large Basins, Western Cascades, Oregon: A Second Opinion. *Water Resources Research* **34**: 3393-3403.
- Thompson**, D.M. 2003. A Geomorphic Explanation for a Meander Cutoff Following Channel Relocation of a Coarse-Bedded River. *Environmental Management* **31**: 385-400.
- Thorne**, C.R. 1998. *Stream Reconnaissance Handbook: Geomorphological Investigation and Analysis of River Channels*. John Wiley and Sons, Chichester, UK.
- Tockner**, K., Malard, F., and Ward, J.V. 2000. An Extension of the Flood Pulse Concept. *Hydrological Processes* **14**: 2861-2883.
- Triska**, F.J. 1984. Role of Wood Debris in Modifying Channel Geomorphology and Riparian

- Areas of a Large Lowland River Under Pristine Conditions: A Historical Case Study. *Verhandlung Internationale Vereinigung Limnologie* **22**: 1876-1892.
- Vannote**, R.L., Minsall, G.W., Cummins, K.W., Sedell, J.R., and Cushing, C.E. 1980. The river continuum concept. *Canadian Journal of Fisheries and Aquatic Science* **37**: 103-137.
- Ward**, J.V. and Stanford, J.A. 1995. The Serial Discontinuity Concept: Extending the Model to Floodplain Rivers. *Regulated Rivers: Research and Management* **10**: 159-168.
- Ward**, J.V. and Stanford, J.A. 1983. The Serial Discontinuity Concept of Lotic Ecosystems. *In Dynamics of Lotic Ecosystems. Edited by T.D Fontaine and S.M. Bartell. Ann Arbor Science, Ann Arbor.*
- Ward**, J.V., Tockner, K., Arscott, D.B., and Claret, C. 2002. Riverine Landscape Diversity. *Freshwater Biology* **47**: 517-539.
- Whiting**, P.J. and Bradley, J.B. 1993. A Process-Based Classification System for Headwater Streams. *Earth Surface Processes and Landforms* **18**: 603-612.
- Wohl**, E.E. 2000. Mountain Rivers. American Geophysical Union, Water Resources Monograph 14, Washington D.C.
- Wolff**, H.H. 1916. The Design of a Drift Barrier Across the White River, Near Auburn, Washington. *Transactions of the American Society of Civil Engineers* **16**: 2061-2085.
- Wolman**, M.G. and Leopold, L.B. 1957. River Flood Plains: Some Observations on their Formation U.S. Geological Survey, Professional Paper 282-C, Washington D.C.
- Wolman**, M.G. and Miller, J.P. 1960. Magnitude and Frequency of Forces in Geomorphic Processes. *Journal of Geology* **68**: 54-74.
- WSDNR, USFWS, USNMFS, USEPA, WDFW, WSDOE, Washington State Tribes, Washington State Association of Counties, Washington Forest Protection Association, and Washington Farm Forestry Association.** 1999. Forests and Fish Report. Olympia, WA.

## Section 3

### Guidelines for Forest Roads

PART 1. OVERVIEW .....	2
PART 2. ROAD MAINTENANCE AND ABANDONMENT PLANNING .....	2
2.1 Road Maintenance and Abandonment Plans .....	2
2.2 Changes in Ownership .....	9
2.3 Family Forest Fish Passage Program .....	9
PART 3. ROAD LOCATION AND DESIGN .....	9
3.1 Location BMPs .....	9
3.2 Design BMPs .....	10
<i>Figure 3.1 Road shape designs</i> .....	11
Table 3.1 Comparison Chart for Road Shape .....	12
PART 4. ROAD CONSTRUCTION AND MAINTENANCE .....	13
4.1 General Construction BMPs .....	13
4.2 Compaction and Stabilization .....	13
4.3 Erosion Control .....	14
4.4 Sediment Control .....	15
4.5 Vegetation BMPs .....	15
4.6 Grading .....	16
4.7 Roadside Vegetation Maintenance .....	16
PART 5. LANDINGS .....	17
PART 6. DRAINAGE STRUCTURES .....	17
Table 3.2 Comparison of Drainage Structures .....	19
6.1 Relief Culverts .....	19
6.2 Dips .....	20
<i>Figure 3.2 Diagram of a rolling dip</i> .....	20
6.3 Water Bars .....	20
<i>Figure 3.3 Diagram of a water bar</i> .....	21
6.4 Drainage Diversions .....	21
<i>Figure 3.4 Diagram of rubber strip diversion structure</i> .....	22
6.5 Ditches .....	22
6.6 Energy Dissipaters .....	22
PART 7. ROAD ABANDONMENT .....	23
7.1 Prioritizing Roads for Abandonment .....	23
7.2 Side Cast and Fill Removal BMPs .....	23
7.3 Water Crossing Removal BMPs .....	23
7.4 Drainage BMPs .....	23
PART 8. ROCK PITS AND QUARRIES .....	24
GLOSSARY .....	25
<i>Figure 3.5 Diagram demonstrating full bench construction.</i> .....	25
<i>Figure 3.6 Diagram showing the road prism.</i> .....	26
RESOURCES .....	27

## **PART 1. OVERVIEW**

### **Background**

Historically, studies have identified forest roads as sources of sediment delivery to streams in Washington's forests. Roads can deliver sediment for a variety of reasons including past practices, neglected maintenance, natural processes, and catastrophic events.

### **Introduction**

This manual provides guidelines to help implement the forest practices road construction and maintenance rules. Correct implementation of current forest practices rules is assumed to minimize runoff water and sediment delivery to typed waters.

Research has demonstrated that well designed and properly maintained roads minimize impacts to public resources and at the same time, reduce operating costs. This manual includes Best Management Practices (BMPs) for forest road location, design, construction, and maintenance (which includes abandonment). The BMPs are grouped into types of activity. For example, ditch construction and maintenance are both under the topic "Ditches."

The listed BMPs will not address every situation nor are all BMPs appropriate for every road. The intent of the BMPs is to provide decision makers with as much flexibility and choice as possible in planning road design, construction, and maintenance activities. If the listed BMPs do not address your situation, you may propose site-specific solutions to the Department of Natural Resources (DNR).

Use of BMPs depends on many factors, including the potential to cause damage to a public resource. For example, timber hauling on a road near a stream may require a higher level of maintenance than a road located away from a stream.

A forest practice activity that includes construction or performance of work within the stream bed or bank of any S, F or N Water is considered a forest practices hydraulic project (FPHP) and may require a FPA (see WAC 222-16-050). For guidelines on planning and designing hydraulic projects, see Board Manual Section 5, Guidelines for Forest Practices Hydraulic Projects.

The manual also provides information on Road Maintenance and Abandonment Plans (RMAPs) and the Family Forest Fish Passage Program. All italicized words are in the attached glossary.

## **PART 2. ROAD MAINTENANCE AND ABANDONMENT PLANNING**

### **2.1 Road Maintenance and Abandonment Plans**

Road maintenance and abandonment plans (RMAPs) are required for all forest landowners. Large forest landowners must prepare a full RMAP for all of their ownership per WAC 222-24-051 and small forest landowners must follow the RMAP requirements in WAC 222-24-0511. Landowners submit RMAPs to the DNR.

Forest landowners are responsible for maintaining all of their forest roads to the extent necessary to prevent potential or actual damage to public resources. This includes both forest roads listed within an RMAP and those forest roads that are exempt from RMAP requirements, such as 80/20 small forest landowners (SFL). The 80/20 SFLs are those who own a total of eighty acres or less of forest land and are not required to submit an RMAP for any block of forest land that contains

twenty contiguous acres or less (WAC 222-24-0511). The type and extent of an RMAP depends on whether a landowner is classified as a **large** or **small** forest landowner. See WAC 222-16-010, for the complete definition of “forest landowner.”

**Large** forest landowners are defined in rule as harvesting more than two million board feet of timber per year from their forest land in Washington State. Large forest landowner RMAP requirements are described in WAC 222-24-051.

- All large forest landowner forest roads under ownership at that time were included in approved RMAPs by July 1, 2006. Part 2.2 of this manual addresses how landowners amend RMAPs to include forest lands acquired since 2006.
- Road work in the approved RMAPs need to be completed by October 31, 2016 or by the extension deadline October 31, 2021 if approved by DNR per WAC 222-24-051(8).

**Small** forest landowners are defined in rule as landowners that:

- Harvest an annual average of two million board feet or less of timber from their forest land in Washington State;
- Have harvested at this level for the past three years; and
- Do not plan to exceed this annual average harvest level for the next 10 years, WAC 222-16-010.

For SFLs that do not meet an exemption to increase their annual timber harvest level over two million board feet, an RMAP will be required for their property (RCW 76.13.120).

SFL RMAP requirements are based on the size of forest land holdings (WAC 222-24-0511).

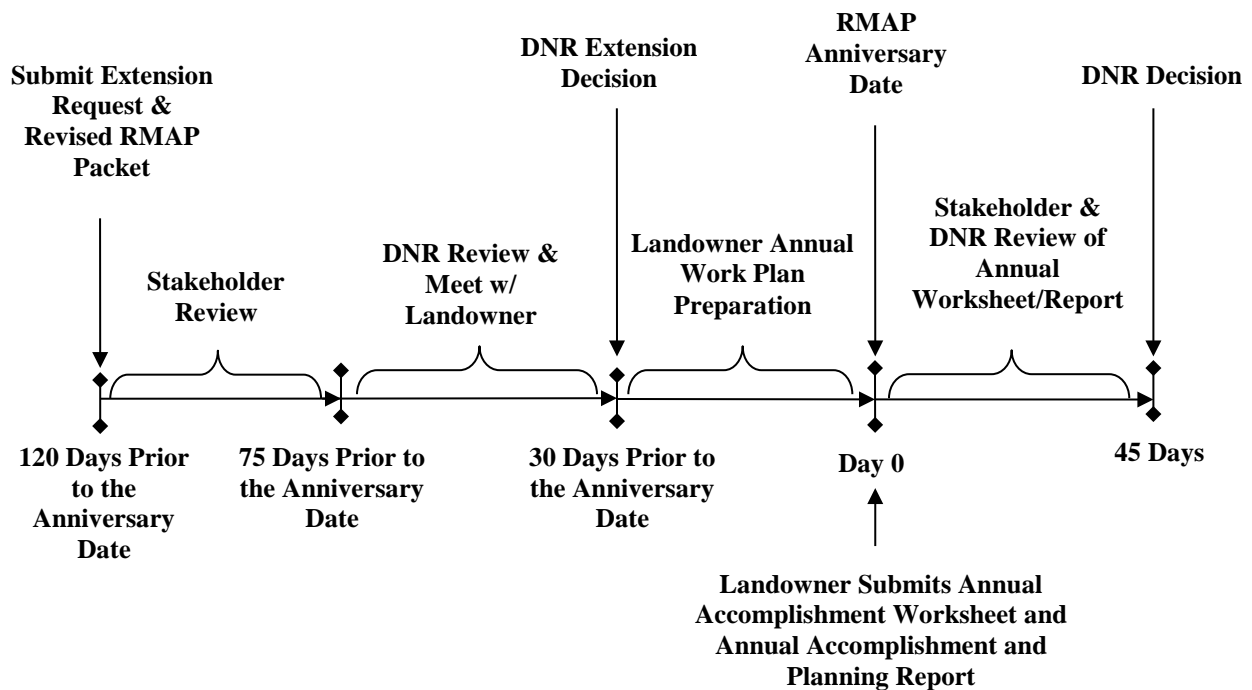
- DNR provides all SFLs with an educational brochure outlining road maintenance standards and requirements, regardless of whether or not the landowner has an RMAP or is required to complete a checklist RMAP with their forest practices application/notification (FPA/N) for harvest (RCW 76.09.420).
- No RMAP is required for 80/20 SFLs.
- A checklist RMAP is required with each FPA/N for timber harvest (including salvage) for SFLs that have ownership greater than 80 acres or have an individual parcel more than 20 contiguous acres.
- If an SFL submits an RMAP, other than a checklist RMAP, the following options apply:
  - Follow the RMAP schedule.
  - Ask DNR to approve changes to the RMAP schedule.
  - Cancel the RMAP by providing written notification to DNR. After cancelation of a RMAP all future timber harvest FPA/Ns must include an RMAP checklist.

### RMAP Review

The Departments of Ecology and Fish and Wildlife, affected tribes, and interested parties (stakeholders) have the opportunity to review existing approved RMAPs, revised RMAPs prepared for extension requests, and annual work plans and schedules for forest landowner road systems. Formal review opportunities for stakeholders will be offered prior to DNR’s decision to approve/disapprove an RMAP extension and/or annual work plans. Early, informal communication is encouraged between forest landowners and stakeholders about road concerns and priorities to help prepare all parties for the review.



Stakeholders will receive copies of all written documentation addressing changes to approved RMAPs.



### RMAP Extension

Large forest landowners operating under an RMAP, and small forest landowners who choose to operate under an RMAP, may apply for an extension of their RMAP completion deadline for up to five years (October 31, 2021). Landowners are strongly encouraged to provide adequate time for DNR and all other reviewers to assess the extension area for the revised RMAP. If the landowner's property is not accessible due to conditions such as inclement weather conditions, the extension may not be approved. Landowners are encouraged to submit their extension requests as early as possible. The last date an RMAP extension can be requested is 120 days prior to the initial RMAP's anniversary date in 2014. Upon receipt of a complete extension request, stakeholders will have at least 45 days to review a revised RMAP. See timeline below.

Requests for an RMAP extension require a revised RMAP that contains the following:

- Extension request form,
- Prioritization and tracking form,
- Maintenance and storm strategy form,
- Accomplishment scheduling worksheet (this schedule demonstrates all remaining RMAP work that will be completed through the extension performance period),
- Annual accomplishment and planning report (summary of all RMAP work), and
- Map(s), specific to the extension request area, showing fish passage barriers and road segments requiring work.

All the standardized forms listed above and detailed instructions on how to fill out the forms are available on DNR's website at

[www.dnr.wa.gov/BusinessPermits/Topics/ForestPracticesApplications/Pages/fp\\_forms.aspx](http://www.dnr.wa.gov/BusinessPermits/Topics/ForestPracticesApplications/Pages/fp_forms.aspx).

The revised RMAP needs to contain the following elements documented on the applicable forms and map(s):

1. An adjusted RMAP accomplishment scheduling worksheet describing how remaining work will be completed on a generally even-flow basis by the extension deadline. The RMAP accomplishment schedule shows how all remaining work will be prioritized using the worst first principle (how the worst problems will be addressed as the highest priority per WAC 222-24-051(3), (4) and (6)), see *Prioritizing RMAP Work* section below. Required road work that is scheduled needs to correspond with locations shown on the forest landowners' maps.
2. Assessment and documentation on the RMAP accomplishment scheduling worksheet of all remaining fish passage barriers, including the dates that fish passage barriers have been removed or fixed. The accomplishment scheduling worksheet needs to demonstrate how the work is being completed consistently on a generally even-flow basis throughout the remaining performance period. This will avoid planning and completing a disproportionate majority of the work at the end of the extended RMAP performance period. Scheduled fish passage barrier work needs to correspond with point locations shown on the forest landowners' maps.
3. Maps showing an inventory of existing conditions for the road system. Road locations need to correspond to the work listed in the adjusted scheduling worksheet. For consistent reporting, use DNR Section or Township base maps (or other comparable map(s); or DNR compatible GIS map products). DNR will accept a range of map(s) from 1:12,000 through 1:60,000 scale. The following elements need to be included on each map:
  - Current existing RMAP boundary as well as the boundaries for the RMAP extension area(s).
  - All forest roads including:
    - Roads and/or road segments requiring work to meet forest practices rule standards.
    - Roads and/or road segments proposed for abandonment (WAC 222-24-052(3)).
    - Stream adjacent parallel roads (identify segments) (WAC 222-16-010).
    - Orphaned roads, and specify those with potential resource risks.
  - All fish passage barrier locations.
  - Type A and B wetlands, as identified on the DNR forest practices wetland GIS layer that lie adjacent to or are crossed by roads.
  - Stream locations and water type(s) as identified on the DNR hydrography GIS layer.

Landowners may place additional work elements on the map that have been included in their RMAP accomplishment scheduling worksheet, such as replacing or removing undersized water crossing structures (non fish) or other road work necessary to minimize sedimentation to typed waters or wetlands (e.g., sidecast pullback, surface water management, etc.).

#### Field Assessment and Screening

Landowners will need to complete an on-the-ground assessment of any portion of the road system that has not already been assessed or when the initial assessment has been rendered inadequate because of major changes that occurred before the RMAP work was complete (e.g., storm damage, landslides or new property acquisition).

The on-the-ground assessment should include, but is not limited to review of the following elements associated with each road segment not meeting current forest practices rule standards:

1. Barriers to fish passage. Water crossing structures need to pass all fish at all life stages (WAC 222-24-010(2)).
2. Undersized culverts or other inadequate water crossing structures on non-fish habitat streams.
3. Mass wasting (landslides) from unstable areas that are affected by roads and threaten public resources and/or public safety.
4. Sediment delivery to typed waters or wetlands.
5. Stream adjacent parallel roads.
6. Interruption of natural drainage patterns where roads intercept springs, seeps, and typed water; including water that is routed out of its natural channel or flow pattern.
7. Road ditches that drain into streams or wetlands.

Refer to the maintenance and storm strategy form for more detailed guidance on road assessment. The form is located at [www.dnr.wa.gov/BusinessPermits/Topics/ForestPracticesApplications/Pages/fp\\_forms.aspx](http://www.dnr.wa.gov/BusinessPermits/Topics/ForestPracticesApplications/Pages/fp_forms.aspx).

#### Prioritizing RMAP Work

Prioritization needs to address the worst situations first, that is, on areas with the highest potential to damage public resources. Prioritization can take place after landowners assess road improvement work needed. In assessing priorities, landowners should consider locations where many small problems exist, and when combined, increase the potential to harm public resources at the watershed scale. Landowners are encouraged to work with the Departments of Ecology and Fish and Wildlife, affected tribes, and interested parties on prioritizing their RMAP work; this will facilitate the efficiency of RMAP review.

Work schedules within RMAPs should be based on each landowner's RMAP priorities (not necessarily in this order):

1. Restoration of fish passage beginning with barriers that affect the most stream miles of fish habitat above the blockage.
2. Repair or maintenance work to reduce sediment delivery from surface erosion and/or mass wasting.
3. Repair or maintenance work to disconnect road drainage(s) from streams.
4. Repair, maintenance, relocation, or abandonment of stream-adjacent parallel roads with an emphasis on reducing water and sediment delivery from the road to the stream.
5. Repair or maintenance work which keeps streams in their natural channels, route groundwater onto the forest floor, and drains ditchwater onto the forest floor and not into the stream.

6. Repair or maintenance work which can be undertaken with the maximum operational efficiencies, getting the maximum amount of work done with available landowner funds, and achieving the most improvement in resource protection as early as possible in the planning period.

#### RMAP Annual Review

Each year on the anniversary date of the plan's submittal, landowners need to report in the forms listed below a current RMAP summary, work accomplishments for the previous year, work proposed for the upcoming year. Any modifications, including storm damage, landslides or new property acquisition (Part 2.2), need to be incorporated into both forms

- Annual accomplishment and planning report (summary of all RMAP work), and
- Accomplishment scheduling worksheet (work accomplishments for the previous year, work proposed for the upcoming year, and any modifications to the existing plan)

The forms and instructions on how to fill out these forms are available on DNR's website at [www.dnr.wa.gov/BusinessPermits/Topics/ForestPracticesApplications/Pages/fp\\_forms.aspx](http://www.dnr.wa.gov/BusinessPermits/Topics/ForestPracticesApplications/Pages/fp_forms.aspx).

The annual accomplishment and planning report needs to illustrate the cumulative progress towards achieving the scheduled RMAP goal to determine if even flow is being met through reporting the percentage of roads improvement completed in each road management block contained within landowners RMAP. In order to meet the requirements in WAC 222-24-051, the annual accomplishment and planning report and the accomplishment scheduling worksheet need to include the following:

1. An annual accomplishment and planning report identifying:
  - Total miles of road within the plan, as well as miles of completed road improvement from the previous year and proposed road improvement for the upcoming year.
  - Total miles of roads needing abandonment, as well as miles of completed road abandonment from the previous year and proposed road abandonment for the upcoming year.
  - Total miles of orphan road within the plan, as well as miles of orphan road mitigated from the previous year and roads proposed for mitigation in the upcoming year.
  - Total number of fish passage barriers within the current RMAP.
  - Total number of fish passage barriers that have been removed/fixed from the previous year and barriers that have been proposed to be removed/fixed in the upcoming year.
  - Approximate number of stream miles of fish habitat access restored.

Locations of the RMAP work listed above needs to be documented on Geographic Information System (GIS) shapefile, electronic spreadsheet, and/or paper map(s).

2. All scheduled work within the last planning period that was not completed as specified on the accomplishment scheduling worksheet. The accomplishment scheduling worksheet needs to show how this work has been rescheduled for completion in subsequent years.
3. Any additional information pertaining to work that needs to be added or removed on the plan (e.g., purchasing new lands, storm damage, or unforeseen circumstances that have altered existing road networks that have not been brought up to forest practices rule standards) needs

to be explained on the annual accomplishment and planning report and added to the accomplishment scheduling worksheet.

4. Detailed scheduling information relating to work that is to occur within the next year (i.e., before the next accomplishment scheduling worksheet).

The DNR, in consultation with Departments of Ecology and Fish and Wildlife, affected tribes, and other interested parties will review the progress of the RMAP on an annual basis to determine if the RMAP is being implemented as approved. The DNR will notify the landowner about any concerns that may need further work or approval within 45 days of receiving the annual accomplishment and planning report and accomplishment scheduling worksheet.

#### Review and Reporting of RMAP Data

Data is reported by landowner's on revised RMAPs, annual reports and schedules, and is reviewed by DNR, landowners, and stakeholders. Landowner RMAP information is submitted to DNR on standardized forms, paper maps, electronic spreadsheet(s), and/or GIS spatial formats. After verifying that RMAP reports are complete and include all required elements, DNR will distribute the RMAP materials to the stakeholders for review.

The DNR distributes to stakeholders and publishes the annual forest practices habitat conservation plan (HCP) report summarizing annual RMAP work accomplished. The annual RMAP accomplishment report consists of RMAP data collected by each region which is combined to provide stakeholders with a statewide picture of the RMAP program status. The annual forest practices HCP report is located on DNR's Forest Practices website at <http://www.dnr.wa.gov/BusinessPermits/ForestPractices/Pages/Home.aspx>.

DNR has created an RMAP database to track large landowners' progress towards meeting RMAP obligations. RMAP stakeholders can use the database to review the work being completed by landowners on their RMAP(s). A year is assigned to each data location, communicating when the work is planned or was completed. This database can be represented spatially in GIS which will allow stakeholders to run limited queries on a watershed basis. This database and its narrative can be found on the DNR's website at [www.dnr.wa.gov/BusinessPermits/ForestPractices/Pages/Home.aspx](http://www.dnr.wa.gov/BusinessPermits/ForestPractices/Pages/Home.aspx).

#### RMAP Completion

Landowner's RMAPs will be considered complete when all roads within the RMAP have been brought up to forest practices rules standards and validated by DNR. The following elements describe the process DNR will follow.

- DNR will consult with the Departments of Ecology and Fish and Wildlife, affected tribes, and interested parties prior to issuing a final acceptance of the RMAP.
- DNR will provide, in writing, confirmation to the landowner that the RMAP(s) is complete.
- Written confirmation of completion will be distributed to the Departments of Ecology and Fish and Wildlife, affected tribes, and interested parties.

Upon completion of an RMAP, landowners will maintain all existing roads according to forest practices rules standards.

## **2.2 Changes in Ownership**

An approved RMAP is a continuing forest land obligation only for large forest landowners per WAC 222-20-055.

If you are a large forest landowner and purchase forest land with an RMAP, you have the following options:

- Follow the RMAP schedule.
- Ask DNR to approve changes to the RMAP schedule.

If you are a **large** forest landowner and purchase forest land without an RMAP, contact DNR for assistance in developing a plan and maintenance schedule.

If you are a **small** forest landowner and purchase land with an RMAP (other than a checklist RMAP), you have the following options:

- Follow the RMAP schedule.
- Ask DNR to approve changes to the RMAP schedule.
- Ask DNR to cancel the RMAP.

## **2.3 Family Forest Fish Passage Program**

Small forest landowners are eligible for the Family Forest Fish Passage Program. This voluntary cost-share program provides financial assistance for removing *fish passage barriers* and replacing them with fish passable structures. The *fish passage barrier* must be located on forest land and cross a Type S or F Water.

A *fish passage barrier* is determined by the state and is any artificial (human-caused) in-stream structure that impedes the free passage of fish. “Fish” includes all life stages of resident and anadromous fish. Cost share rates range from 75%-100%.

For an application and information, see [www.dnr.wa.gov/ffpp](http://www.dnr.wa.gov/ffpp) or contact the Small Forest Landowner’s Office at any DNR region office.

## **PART 3. ROAD LOCATION AND DESIGN**

(Rules are in WAC 222-24-015, WAC 222-24-020, and WAC 222-24-026.)

The location of a road may have long-term effects on construction and maintenance costs, safety, and public resources. A well located, designed, and constructed road balances current and future needs with construction and maintenance costs. Base the final road location on field verified information, BMPs, and local knowledge.

### **3.1 Location BMPs**

When necessary to cross water, find the optimal water crossings first and locate roads to:

- Utilize topographic features such as benches, ridges, and saddles.
- Use natural grade breaks to locate drainage structures. This prevents long continuous ditches.
- Avoid crossing or constructing roads adjacent to wetlands. When wetlands are present, refer to WAC 222-24-015(1) for an ordered list of choices for road location and construction. Recommendations on wetland restoration, enhancement or replacement are in Board Manual Section 9, Guidelines for Wetland Replacement by Substitution or Enhancement.
- Disconnect the road drainage from typed waters.

Reduce risks to public resources by minimizing the amount of roads in the following locations:

- On side slopes greater than 60%.
  - If you plan to construct roads in these areas, you may be required to use *full bench construction* techniques.
- On unstable slopes and landforms. For guidance, see Board Manual Section 16, Guidelines for Evaluating Potentially Unstable Slopes and Landforms.
  - If you plan to construct roads in these areas, you may need to perform additional environmental review (see WAC 222-16-050, Class IV-special).
- In areas with a history of road failures or slides.
  - If you plan to construct roads in these areas, research the factors that contributed to the failures and plan to avoid past road location, construction and maintenance techniques. You may be required to perform additional environmental review (see Board Manual Section 16, Guidelines for Evaluating Potentially Unstable Slopes and Landforms and WAC 222-16-050, Class IV-special).
- Within 200 feet of typed waters.
  - Note: New stream adjacent parallel roads require an interdisciplinary team.
- In or near seeps and springs.
  - If you plan to construct roads through seeps and springs, maintain the natural flow patterns around them. The flow pattern often has wetland indicator plants and soils.

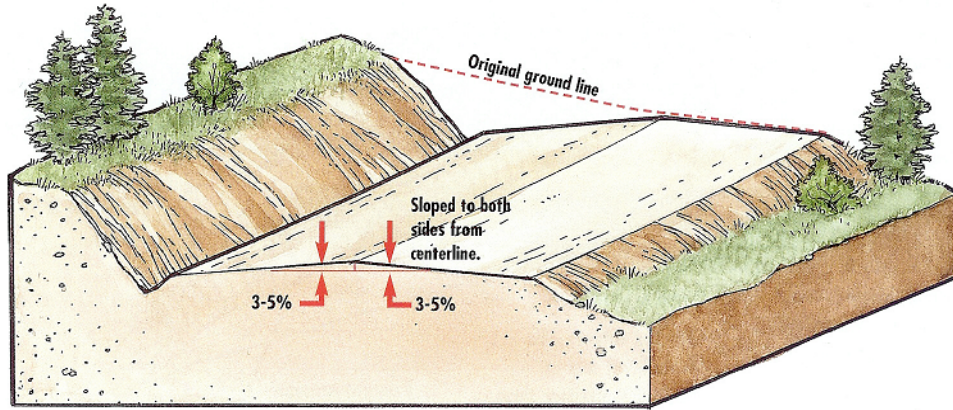
### **3.2 Design BMPs**

Once you have selected a road location, design the road to minimize sediment delivery to typed waters by:

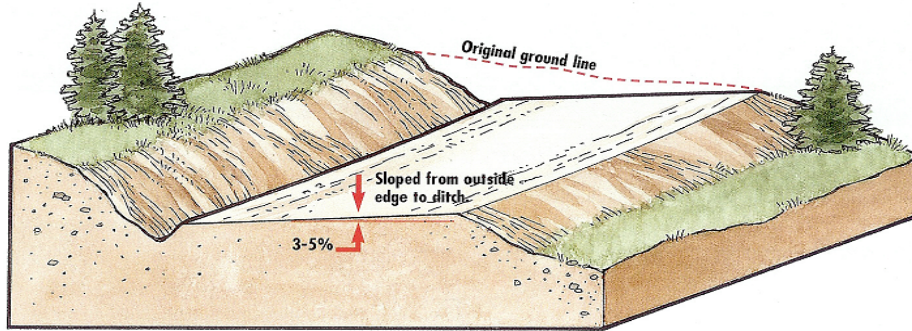
- Including adequate drainage structures for anticipated surface and intercepted sub-surface flow.
- Ensuring the sub-grade and surface can support log and rock haul during the planned season of road use.
- Not constructing sunken roads. These are roads lower than the surrounding ground level, and do not drain properly. Sunken roads occur on gently sloped land where cut and fill is unnecessary. In these locations, it may be necessary to build up the road surface so that water drains away from the road surface.
- Incorporating grade breaks to avoid long, continuous road grades.

Design the road shape (crowned, inslope, outslope) to support the anticipated haul of timber, rock, etc. Figure 3.1 shows cross section views of road sub-grades by type of road shape. Table 3.1 offers a comparison chart to help determine the best road design for your location.

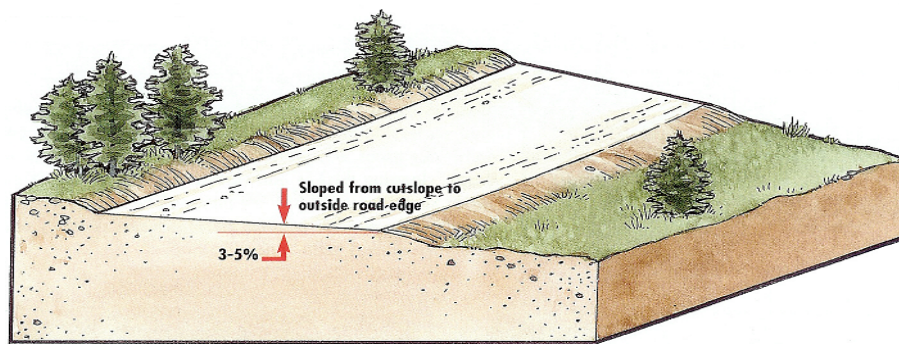
**Crowned**



**Inslope**



**Outslope**



*Figure 3.1 Road shape designs*



**Table 3.1 Comparison Chart for Road Shape**

	<b>Inslope</b>	<b>Outslope</b>	<b>Crown</b>
Road surface shape	Drains towards the <b>cut</b> slope using the road or ditches.	Drains towards the <b>fill</b> slope using dips, not ditches.	Drains <b>both</b> directions with high point in center of road.
Construction requirements	Requires more excavation and clearing.	Requires less excavation and clearing.	Will require excavation and clearing quantities between inslope and outslope.
Maintenance requirements	Road surface  Ditch and relief structures	Road surface  Dips  Fill slopes – vegetation or stabilization	Road surface  Ditch and relief structures  Fill slopes – vegetation or stabilization
Erosion concerns	Road surface  Ditches  At relief culverts and outlets	Road surface  Fill slope  Dips and dip outlets	Road surface  Ditches  At relief culverts and outlets  Fill slopes
Where to use	When keeping runoff water in the ditch is critical to controlling sediment delivery.  Unstable or erodible fill slopes  Steep grades  When hauling in ice or snow conditions	Rocky or well drained soils  Where unable to maintain ditches  Stable fill slopes  On temporary or spur roads that are less than 8% grade.	Unstable or erodible fill slopes  Steep grades  When hauling in ice or snow conditions  High traffic roads
Where not to use	Where ditches and relief culverts have high probability of clogging.  Where ditches cannot be constructed.	Steep road grades  High traffic roads  Unstable fill slopes  Where safety concerns exist, such as for use during ice or snow.	In areas, where outsloping the road is adequate.  Temporary roads

## **PART 4. ROAD CONSTRUCTION AND MAINTENANCE**

Road construction techniques are important to prevent potential and actual damage to public resources.

### **4.1 General Construction BMPs**

(Rules are in WAC 222-24-030)

- Provide road construction operators with well-marked road locations, readable road design information, and clear instructions.
- Supervise road construction operators to:
  - Ensure road width and cut depths match design specifications.
  - Respond to unanticipated circumstances.
- Construct roads when moisture and soil conditions are not likely to result in excessive erosion and/or soil movement.
- Minimize the area of soil disturbance during construction.
- Place all clearing debris and slash (such as tree limbs, stumps and brush) outside the road prism.
- For roads near typed water, place all clearing debris on the downhill side of the road at the toe of the road fill. This can trap sediment.
- New, non-compacted roads may need time to settle (several weeks or more) before rock or timber haul.
- Place a *geotextile fabric* over an inferior sub-grade before applying the surfacing material. This spreads vehicle load over the entire sub-grade and helps prevent the surfacing rock from sinking into the sub-grade soil.
- When crossing wetlands, follow the ordered list of choices for road location and construction in WAC 222-24-015(1). Recommendations on wetland restoration, enhancement or replacement are in Board Manual Section 9, Guidelines for Wetland Replacement by Substitution or Enhancement.

### **4.2 Compaction and Stabilization**

(Rules are in WAC 222-24-030 and WAC 222-24-035.)

#### **General Compaction BMPs**

Compaction of the embankment, road sub-grade and landings ensures a solid earthen structure.

- Compacting the embankment reduces potential failure and surface erosion.
- Compacting the sub-grade extends the life of the running surface. It also reduces sediment runoff from the pumping of fine sediments upward into the road ballast and surfacing.
- Compacting the road surface and landings can shorten the settling time, extend rock surface life, and reduce sediment production during rainy weather.

For best compaction results:

- Place soil in 1 to 2 foot layers and run excavation equipment over the entire width of the lifts.
- Avoid incorporating organic material into any area to be compacted.
- Compact during optimal soil moisture conditions. Determine this through observation and experience with different soil types. In soils with silt or clay, ideal soil moisture content is when you can squeeze the soil into a cohesive ball without having water form on the outside.

### Special Case BMPs

In some instances, apply these additional techniques to enhance the sub-grade and road surface:

- On heavily used roads or where rock is expensive, use a roller to compact the sub-grade and surfacing. This extends the life of the road by:
  - Reducing the water intrusion.
  - Reducing the wear.
  - Improving the sub-grade's durability.
  - Maintaining the crown.
  - Enhancing the surfacing.

For this technique:

- Place surfacing in layers before compacting.
- Compact in several passes depending on the layer thickness. When there is no visible deformation of the surface, compaction is complete.
- If the sub-grade or surface rock is dry, spray on water or use a roller with a built in spray bar.
- If using a vibratory roller:
  - Place surfacing in 4 to 6 inch layers before compacting.
  - Compact until a sheen of water and fines rise to the surface.
- Use hard, angular rock that has a full range of fragments to tightly pack the road surfacing.

### Stabilization BMPs

Stabilize all disturbed soils that have a potential to deliver sediment to typed waters. Stabilization methods include establishing vegetation and covering exposed soils with *bio-matting*, straw, tree boughs, or hydro mulching.

Waste soil (spoil) deposit areas should be located where material will not enter any typed waters if erosion or failure occurs. An area with stable, shallow slope topography is best suited for a spoil area. Compaction of spoil deposit areas reduces potential embankment failures, surface erosion, and helps fit material into waste areas. Apply the compaction techniques to spoil deposit areas:

- For best results, handle spoils when they are dry. Handling super-saturated material may require sediment controls (e. g., *silt fence*, berms, straw).
- Seed or plant disturbed soils with non-invasive plant species (native plants are preferred). Consider adding fertilizer and/or mulch if the site has poor nutrient quality and/or organic content.

### 4.3 Erosion Control

Erosion control measures are necessary if exposed soils can deliver sediment to typed waters. The key to controlling sediment is to control erosion. The best way to control erosion is to prevent it by:

- Covering all exposed soils with non-invasive plant species as soon as possible (native plants are preferred). Until the area can be vegetated, apply straw, logging slash or *fiber mats* to the exposed soil to prevent erosion from raindrop splash. This not only protects and holds soil particles from the erosive effects of rainfall; it also prevents the spread of noxious weeds.
- Scheduling construction during dry soil conditions.

#### **4.4 Sediment Control**

The goal of sediment control is to create a stable, dispersed, non-erosive drainage pattern. This minimizes potential or actual sediment delivery to typed waters. Where needed, sediment control BMPs include:

- Excavating *dead sumps* to intercept and settle sediment-laden water.
- Building *sediment traps* in ditch lines to create small sediment settling pools. Make *sediment traps* from rock, *straw wattles*, or sand filled bags. Orient the traps so they dip in the center and curve slightly. This keeps the flow centered in the ditch.
- Installing *slash filter windrows* to intercept sediment at the toe of fills over water crossings.
- Installing a secondary ditch or a raised berm over water crossings.
- Placing *straw wattles*, *silt fencing*, or *slash filter windrows* perpendicular to the hill slope to slow down and disperse water flow.

Use *sediment traps*, *silt fences* or *dead sumps* only as temporary or remedial measures because they require continuous maintenance. Install temporary *sediment traps* in any of the following situations:

- If erosion or sediment is likely to deliver to typed waters.
- If roads are built of erosive, native soils.
- If cut and fill slopes are difficult to vegetate.

#### **BMPs for roads within 200 feet of typed water**

Apply one or more of the following techniques on roads built of erosive native soils, or are likely to have ditch erosion, or have cut or fill slopes that are difficult to vegetate:

- Grass seeding.
- Armoring ditches.
- Constructing catch basins.
- Constructing temporary *sediment traps*.
- Rocking road surfaces near water crossings.

In situations where sediment control devices need to be used long-term consider surfacing that requires little to no maintenance such as chip sealing or paving portions of roads.

#### **4.5 Vegetation BMPs**

Consult with the Natural Resource Conservation Service, a county extension office or a State resource agency (DNR, Ecology, Agriculture) to determine the type of seeds and/or plants to use. Factors to consider are:

- Type of soils and soil conditions, including moisture content and degree of compaction.
- Available seed/plant sources (native plants are preferred).
- Costs and methods of seeding or planting.
- Avoiding invasive plant species.
- Matching the time of year the site is accessible with the appropriate planting of seed and/or plants.
- Topographic aspect, north or south facing slopes.

When applying grass seed to exposed soils:

- Consider using *straw blankets* or loose straw if soil moisture is low. Apply straw 3-6 inches thick.
- Seed during times of year that will allow germination without additional site visits to apply water.

#### **4.6 Grading**

To protect the sub-grade, grade a road before the surface reaches severe stages of pothole formation, wash boarding, or it begins to pool water. Grade only as needed to maintain the surface drainage and keep the sub-grade from becoming saturated.

##### **Grading BMPs**

- Determine the cause of potholes and wash boarding and fix the problem. The problem is usually standing water.
  - Cut out potholes and wash boarding. Pull road surfacing back onto running surface. This reduces water penetration and sub-grade saturation. Long-term solutions include restoring the road crown, adding rock, adding culverts, and ditching to reduce water in the road prism.
- Remove berms except those needed to carry water away from unstable slopes and/or typed waters.
- Compacting the graded surface with a roller will:
  - Seal the surface and retain fines.
  - Reduce potholes.
  - Reduce wash boarding.

Avoid the following practices:

- Unnecessary removal of all vegetation in functioning ditches.
- Undercutting the fill or cut slopes.
- Pushing sediment over steep slopes above typed waters.
- Burying vegetation, logging debris and slash into the road running surface or sub-grade. (Decomposition of this material will leave holes in the road surface. Traffic on this surface may cause sediment delivery to typed waters.)

#### **4.7 Roadside Vegetation Maintenance**

The purpose of roadside vegetation maintenance is to increase visibility, improve safety, control noxious weeds, and to keep roots from interfering with the roadbed and ditches. Methods include chemical application, hand brushing, and mechanical brushing.

##### **Roadside chemical application BMPs**

- Find and mark the location of all surface waters and wetland management zones immediately before applying roadside spray.
- Mix chemicals in upland areas away from all typed waters and Type A and B Wetlands.
- Prevent chemicals from entering any surface waters and Type A and B Wetlands and their buffers.
- Follow all label instructions.
  - Know and follow regulations regarding chemical storage, handling, application, and disposal.

- Develop a contingency plan for spills, including clean-up procedures and proper notification. Keep this plan on site during operations.
- Apply chemicals during optimum weather conditions and optimum times for control of target vegetation. See Board Manual Section 12, Guidance for Application of Forest Chemicals.

#### Mechanical Brushing BMPs

- Remove brush to a width that allows proper maintenance functions such as grading, trimming shoulders, pulling ditches, and cleaning headwalls.
- Upon completion, remove all debris and/or slash generated during mechanical brushing that will interfere with proper function of ditches or culverts.

### **PART 5. LANDINGS**

WAC 222-24-035(1) states, “Locate landings to prevent potential or actual damage to public resources. Avoid excessive excavation and filling. Landings shall not be located within natural drainage channels, channel migration zones, RMZ core and inner zones, Type Np RMZs, sensitive sites, equipment limitation zones, and Type A or B Wetlands or their wetland management zones.”

Landings can deliver sediment through runoff or mass failures (landslides). Reduce costs and risks to public resources by minimizing the number of landings on steep erosive slopes or large fills.

Utilize the road BMPs in Part 3 Road Location and Design and Part 4 Road Construction and Maintenance when locating, designing, and constructing landings.

#### General landing BMPs

- Use existing landings if properly located.
- Design landings to provide for drainage:
  - Slope landings 2-5%.
  - Install cross drains, ditch-outs, or other drainage structures to route runoff onto the forest floor away from typed waters. See Part 6 Drainage Structures.
  - Compact if appropriate. See 4.2 Compaction and Stabilization.
- Construct when moisture and soil conditions are not likely to result in excessive erosion and/or soil movement.
- After completion of harvest:
  - Pull back fill material and woody debris on steep slopes that have the potential to damage a public resource. Place debris in a stable location.
  - Install self-maintaining drainage structures. See Part 6 Drainage Structures.

### **PART 6. DRAINAGE STRUCTURES**

Landowners should take into account the need to reduce cumulative watershed effects from road sediment delivery to public resources. More intensive road work is needed in areas with closely spaced stream crossings and stream adjacent parallel roads. In these settings, not only are the potential impacts from road greater, but it may be difficult to find locations to direct sediment laden road run-off onto the forest floor. Where it is difficult to accomplish this there is greater value in applying BMPs that reduce sediment generation (e.g. improved surfacing) and ditch

transport (e.g. silt traps). Drainage structures include relief culverts, dips, water bars, diversions, ditch-outs, and ditches. Drainage structures divert water and sediment from the road to the forest floor. They also disconnect road drainage from typed waters or Type A and B Wetlands. The frequency of drainage structures depends on several factors, such as:

- Road grade.
- Surface material.
- Elevation.
- Expected rainfall.
- Soil type.
- Road shape (inslope, outslope, crowned).
- Topographic opportunities for road drainage.
- Location of existing and/or planned drainage structures.
- Opportunity created by the road configuration.
- Local experience.

Install drainage structures in the following locations and order of priority:

1. As close to the stream as possible, to accomplish the following:
  - Limit the distance between the last drainage structure and water crossing structure.
  - Drain away from unstable hill slopes and/or erodible soils.
  - Allow outflow to disperse and filter sediment away from the stream.
2. In natural drainage areas of seeps and springs. If unable to install a drainage structure in the natural drainage area, divert and transport seep or spring water in a ditch for less than 100 feet to the nearest drainage structure.
3. To prevent diverting water from one basin to another.
4. At the low point on the road profile (including the sag point of vertical curves).

You may need to install additional drainage structures or improve road surface where:

- Ditch water delivers sediment to typed waters.
- The road is a stream adjacent parallel road.
- The density of stream crossings is high, resulting in most of the ditch length draining to streams.
- Ditch scour, road surface erosion, or outlet erosion is occurring from high ditch flow.
- Ditch flow exceeds the capacity of the culvert.

Table 3.2 compares the construction costs, maintenance needs, and appropriate uses of relief culverts, dips, and water bars.

**Table 3.2 Comparison of Drainage Structures**

	<b>Relief Culverts</b>	<b>Dips</b>	<b>Water bar</b>
Construction costs	Highest	Medium	Lowest
Maintenance	Medium Needs frequent inspection and cleaning.	Lowest Needs occasional repair or reshaping.	Highest Needs frequent cleaning, reshaping and replacement.
When to use	On steep road grades. On high traffic roads. At the low point of the sag of vertical curves or dips.	On low traffic roads. On outsloped roads. To back up culverts. On dry sites and native surfaced roads.	On low traffic roads. On abandoned roads. To back up culverts. To winterize high traffic roads.
When not to use	On difficult to maintain roads. On seasonal roads. Below unstable or raveling cut slopes.	On steep grades (>12 %). On curves. On high traffic roads.	On high traffic roads.

### **6.1 Relief Culverts**

Relief culverts divert road and ditch water onto the forest floor. Improper location of relief culverts may result in significant road-related resource damage. Overloading a site with drainage water can result in soil saturation and may cause overland flow, gullyng and slope instability.

For guidance on planning and designing forest practices hydraulic projects, see Board Manual Section 5, Guidelines for Forest Practices Hydraulic Projects.

#### **Installation BMPs**

- Where practical, place the culvert on the natural slope of the land with the low end of the culvert at least 2 inches lower than the upper end. When impractical, keep the culvert grade at least 2% higher than the ditch grade.
- Skew the culvert so it directs water 30 to 45 degrees from perpendicular to road centerline.
- No skew is necessary on roads less than 3% grade or at a low point on the road profile.
- Anchor the culvert by packing fill material around it.
- Cover tops of culverts with 12 inches of fill or ½ the culvert's diameter whichever is greater. (This minimizes damage from vehicles by preventing the culvert from crushing.)
- Install energy dissipaters such as flumes and down spouts on slopes greater than 60% or where the outfall drains onto fill or other erosive material.

#### **Maintenance BMPs**

- Inspect and clean culverts routinely and after storm events.



- Check need for additional cross drains for springs, seeps, low spots in ditch lines, and areas where ditch line erosion is occurring.
- Mark hidden relief culverts with posts so heavy equipment operators can see and protect them.
- Remove brush from around inlets and outlets to see problems and reduce the risk of blockage.

## **6.2 Dips**

Dips are long, shallow road surface drainage structures that provide cross drainage on insloped road sections (Figure 3.2).

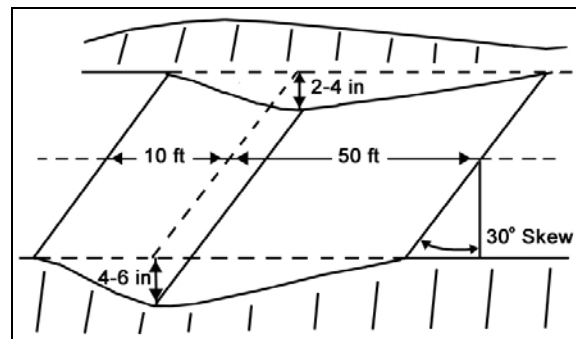


Figure 3.2 Diagram of a rolling dip

Road grades from 12% to 15% are the upper limits for dips because:

- If the dip becomes lower than the outfall it will not drain properly, impeding traffic and causing ruts and sedimentation.
- Truck frames can twist during passage over dips on steeper slopes.

Construct dips:

- To provide access for road maintenance and land management activities. When the dip is:
  - Short in length and traffic includes trucks with long frames, orient the dip perpendicular to the direction of traffic.
  - On steep road grades, skew the dip 30 degrees from perpendicular to provide drainage.
- With rock armoring on erosive native surface roads.
- With grass-seeded outflows when near typed waters.

## **6.3 Water Bars**

Water bars divert surface water directly across the road and fill slopes to the forest floor (Figure 3.3).

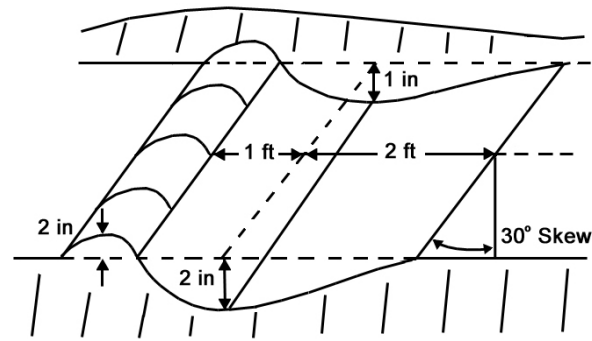


Figure 3.3 Diagram of a water bar

#### General water bar BMPs

- Install water bars at a gradient steep enough to provide self-cleaning drainage with minimal maintenance:
  - For roads greater than 3% grade, skew at least 30 degrees from perpendicular to the centerline.
  - For roads less than 3% grade or at the bottom of a dip, install them perpendicular to the centerline.
- Locate outflows on stable areas.
- Construct water bars into the cut slope to block the ditch. These act as “safety valves” for failed relief culverts. They work best as temporary measures on low traffic roads with an inadequate number of relief culverts.
- Armor water bars at potential scour points (outflows, trench bottoms) with rock or other energy dissipaters.
- Construct temporary water bars for over-wintering by dumping piles of surfacing rock on the road. Later, grade them out for surfacing material.

#### 6.4 Drainage Diversions

In rare circumstances (e.g., approaches to streams with wet weather haul), install diversion structures to drain the surface of the roadway (Figure 3.4). These work best on low traffic roads and include:

- I-beams set in the road surface with edges on grade and at a 30 degree skew to the road centerline. The I-beam acts as a gutter to collect surface runoff and carry it away from the road surface.
- Rubber strips installed in the road surface at a 30 degree skew to the road centerline (Figure 3.4). Mount the strips on buried wood or steel beams making sure that they stick above the road surface. Studies identified the following limitations to these surface water deflectors:
  - PVC belting tends not to rebound well under traffic and bends over parallel to the road grade. Rubber-laminated belting has less of this problem.
  - Road grading can rip these diversion structures out.
  - Heavy winter hauling causes the top of some belting to fray and delaminate.
  - On road grades less than 6%, potholes formed in the wheel ruts on the uphill side of the rubber strip.

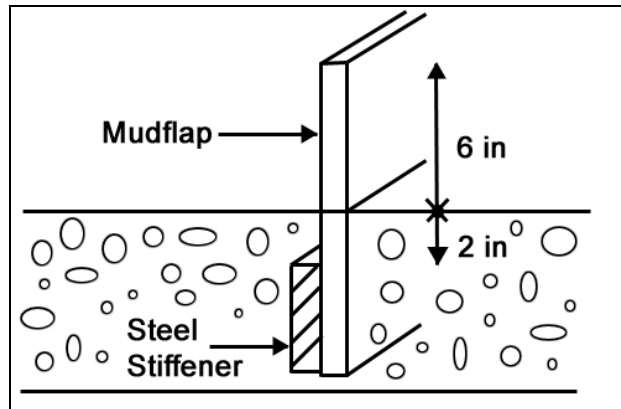


Figure 3.4 Diagram of rubber strip diversion structure

### **6.5 Ditches**

Ditches carry road runoff water to drainage structures.

#### **Installation BMPs**

- Typically, ditches should be at least one foot deeper than the road prism and have an approximate 2:1 slope on either side.
- If the ditch has the potential to drain a wetland, refer to WAC 222-24-015.

#### **Maintenance BMPs**

- Maintain ditch vegetation within 100 feet of water crossings. Vegetation filters sediment from ditch flow.
- Pull ditches only when necessary to maintain drainage. This helps maintain ditch function during a major storm event.
- Clean ditches of all debris generated during logging. Place this material on the downhill side of the road near the base of the fill.
- Do not undercut the road cut slope.
- Match equipment with the type of maintenance work required. Excessive excavation will create potential sediment delivery.
- Remove slides from the ditches and roadway. See 4.2 Compaction and Stabilization.

### **6.6 Energy Dissipaters**

The location and design of energy dissipaters is critical to prevent concentrated water runoff flows and gully formation on fill slopes or the forest floor. Install energy dissipaters on:

- Slopes greater than 60%.
- Erosive soils.
- Drainage structure outfalls.

Energy dissipaters include:

- Flumes or downspouts (half culverts staked into place).
- Large rock placed below outfall.
- Large woody material placed below outfall.

## **PART 7. ROAD ABANDONMENT**

(Rules are in WAC 222-24-052(3).)

An approved FPA for a forest practices hydraulic project (FPHP) may be required when abandoning roads within S, F or N Waters. For guidance when abandoning roads, see Board Manual Section 5, Guidelines for Forest Practices Hydraulic Projects.

The goal of road abandonment is to re-establish the natural drainage and to leave the *road prism* in a condition that will not damage public resources or pose a risk to public safety. Abandoned roads do not require maintenance. See 4.3 Erosion Control.

### **7.1 Prioritizing Roads for Abandonment**

Consider abandonment of chronic problem roads that require frequent maintenance to protect public resources, such as:

- Stream adjacent parallel roads.
- Roads within a riparian management zone.
- Areas with uncontrollable erosion and/or sediment delivery to typed waters.
- Water crossing failures.
- Cut and fill slope failures.

### **7.2 Side Cast and Fill Removal BMPs**

Remove side cast and fills if failures have the potential to damage a public resource or pose a risk to public safety. Areas to look for include:

- Cracks and slumps in the road surface or shoulder.
- On unstable slopes or landforms (see Board Manual Section 16, Guidelines for Evaluating Potentially Unstable Slopes and Landforms). The material should be end hauled to a stable location.
- Where the weight and volume of side cast material could cause a slide.

Removal methods:

- Place all excavated material against the cut slope or other stable location. Do not place in areas on the road surface that will allow water to pond.
- On steep slopes in high rainfall areas, do not place excavated material on the road surface. This material will become saturated and unstable.

### **7.3 Water Crossing Removal BMPs**

Removing water crossing structures restores the natural drainage of streams. When removing water crossing structures:

- Re-establish the natural streambed as close to the original location as possible and so it matches the up and downstream width and gradient characteristics.
- Place all excavated material in stable locations.
- Leave stream channels and side slopes at a stable angle.

### **7.4 Drainage BMPs**

Install self-maintaining drainage structures that will not require future maintenance. Provide for drainage by:

- Removing relief culverts. Make sure side slopes are left at a stable angle.
- Removing berms or punching holes in them so they drain to a stable location.
- Ripping the road surface to promote re-vegetation.
- Installing non-drivable water bars:
  - To intercept the ditch. Make sure to key the water bar into the road cut-slope.
  - To direct outflow onto stable locations.
  - That are appropriately skewed:
    - For roads greater than 3% grade, skew at least 30 degrees from perpendicular to the centerline.
    - For roads less than 3% grade or at the bottom of a dip, install them perpendicular to the centerline.
  - At a spacing to disperse runoff and minimize erosion and sedimentation.
  - At natural drainage points.

## **PART 8. ROCK PITS AND QUARRIES**

(Rules are in WAC 222-24-060.)

### General maintenance and operation BMPs

- Excavate and maintain sediment retention ponds when needed.
- Protect all typed waters from sediment delivery due to erosion. See 4.3 Erosion Control.
- Know and comply with regulations regarding storage, handling, application, and disposal of all chemicals and fuels. Follow all label instructions.
- Develop a contingency plan for spills, including clean-up procedures and proper notification. Keep this plan on site while operating.
- Store fuel and other chemicals in a bermed area to minimize potential delivery to surface waters or wetland management zones.

## GLOSSARY

**Bio-matting** is a biodegradable woven mat that comes in various lengths. It is rolled in place and then staked to help stabilize slopes. Includes **fiber mats**.

**Fish passage barriers** are any artificial in-stream structures that impede the free passage of fish.

**Forest practices hydraulic project** means a forest practices activity that includes the construction of performance of work that will use, divert, obstruct or change the natural flow or bed of any Type S, F or N Waters. Stand-alone proposals involving channel change and realignment, dredging in fresh water areas, and constructing outfall structures are not forest practices hydraulic projects and remain governed by chapter 77.55 RCW and chapter 220-110 WAC.

**Full bench road construction** is a road constructed on a side hill without using the material removed from the hillside as a part of the road (Figure 3.5). This is common on steep and/or unstable ground. Two methods to remove spoil material (excess material cut from the hillside) are:

- "End hauling", where the spoil material is hauled to a suitable waste area.
- "Overhaul", where the spoil material is pushed to a suitable waste area.

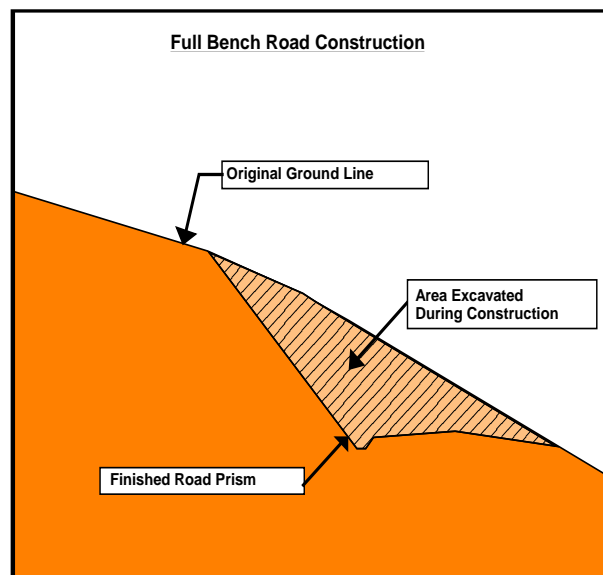


Figure 3.5 Diagram demonstrating full bench construction.

**Geotextile** is a fabric mat that allows water to drain through it while supporting the materials located above it.

**Mitered culverts** are culverts that have had the inlet or outlet cut to fit the angle of the fill slope.

**Road Prism** is the area of the ground containing the road surface, cut slope, and fill slope. See Figure 3.6.

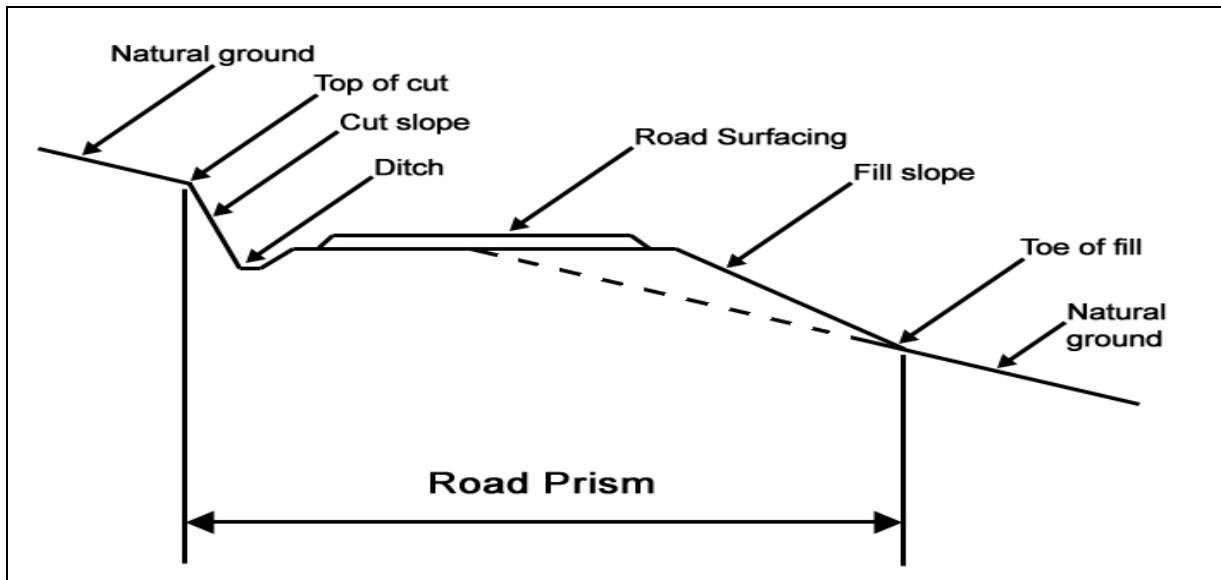


Figure 3.6 Diagram showing the road prism.

**Sediment traps** are small temporary pooling areas, which collect and store sediment before diverting runoff water onto the forest floor. Sediment traps are usually excavated or constructed earthen embankments with a gravel outlet. Examples include:

**Check dams** constructed in a ditch to decrease flow velocities, minimize channel scour, and capture and store sediment.

**Dead sumps** are sediment traps without an outlet.

**Silt fence** is a tightly woven plastic fabric that comes in long rolls. The fabric is strung between wooden stakes. Silt fences are often used adjacent to waterways to prevent sediment from entering water. They are also used adjacent to disturbed soil areas to control erosion.

**Spoils** are excavated soils deposited in approved waste soil areas.

**Straw blankets** are made of straw stitched to a single net.

**Straw wattles** are tubes of straw used for erosion control, sediment control and runoff control. Wattles help to stabilize slopes by shortening the slope length and by slowing, spreading, and filtering overland water flow. This helps to prevent sheet erosion as well as rill and gully development, both of which occur when runoff flows uninterrupted down a slope.

**Slash filter windrows** are erosion control structures constructed of piled slash in a continuous row along the base of fill slopes. They are especially useful on fill slopes above water crossing culverts to catch road surface runoff that is flowing on the outside of the road.

## RESOURCES

**British Columbia Ministry of Forests**, Forest Practices Code of British Columbia, Forest Road Engineering Guidebook, Second Edition, June 2002. [www.gov.bc.ca/](http://www.gov.bc.ca/)

**Fifield**, Jerals S. (2002). Field manual on sediment and erosion control best management practices for contractors and inspectors. Forester Communications. (Preface states that no part of book can be reproduced or utilized in any form or by any means, electronic or mechanical, including photocopying, recording, or by any information storage and retrieval system, without written permission from the publisher.)

**Johansen**, David Kim, 1997. Relief Culverts. San Dimas Technology and Development Center. United States Department of Agriculture, Forest Service, Technology and Development Program. 9777 1812-SDTDC.

**Minnesota Forest Resources Council**: <http://www.frc.state.mn.us>

**National Council for Air and Stream improvements**, Inc. (NCASI). 2000. Handbook of control and mitigation measures for silvicultural operations. Unpublished draft Technical Bulletin. Research Triangle Park, NC: National Council for Air and Stream Improvement, Inc.

**Oregon Department of Forestry**, Forest Roads Manual, June 2000.

**USDA Natural Resources Conservation Service**. 1996. Engineering Field Handbook - Stream bank and Shoreline Protection. Part 650, Chapter 16. [local NRCS office]

**USDA Natural Resources Conservation Service**. 1996. *Watershed Technology Electronic Catalog*. [<http://www.wcc.nrcs.usda.gov/wtec/wtec.html>]

**USDA Forest Service (USFS)**. 2000. Water/Road Interaction Technology Series: “Diversion Potential at Road-Stream Crossings”; “Response of Road-Stream Crossings to Large Flood Events in Washington, Oregon, and Northern California” By M. Furniss et al., Technology and Development Program. San Dimas, CA. [(909)599-1267]

**Washington State Department of Ecology**, Permit Assistance Center, <http://www.ecy.wa.gov>

**Washington Department of Fish and Wildlife**.

2003. Design of Road Culverts for Fish Passage. Bates, K.M. et al.

<http://wdfw.wa.gov/publications/00049/wdfw0049.pdf> **Wetland plant indicators:**

<http://plants.usda.gov>



## **Section 4**

### **Guidelines for Clearing Slash and Debris from Type Np and Ns Water**

In cases such as those described in WAC 222-24-030(5), channel clearance, slash and debris that may reasonably be expected to plug new culverts on Type Np or Ns Waters must be cleared from the channel for an upstream distance of 50 feet. Debris removed from the channel in these circumstances must be placed downstream from the culvert and outside the 100-year flood level, or as otherwise required in an approved FPA for a forest practices hydraulic project (FPHP). Slash and debris that are excluded from these cases include logs that are embedded along their length or at least substantially at one end, and slash buried under stable deposits of soil, rocks or woody debris. Do not limb, buck, notch, or remove trees and logs that are to be left in the stream channel or are firmly embedded.

Large accumulations of slash may contribute to the initiation or exacerbation of mass wasting events (e.g., debris slides and debris torrents); however, these events are expected to be rare because current forest practice rules prohibit the machine piling of slash and debris within 30 feet of unbuffered stream banks. Likewise, limbing and bucking within the bankfull channel of Type S, F, Np waters, RMZ core zones, sensitive sites, or open water areas of Type A wetlands is prohibited (WAC 222-30-050(2)). In the event that slash or debris must be removed from the channel within a Type S, F or Np Water, an approved FPA for a FPHP is required. For technical guidance, see Board Manual Section 5, Guidelines for Forest Practices Hydraulic Project.

The benefits of retaining slash are tied to soil, fish and wildlife, and other public resources. Small woody debris (<4 inches diameter) provides cover for a variety of riparian-dependent amphibians and small mammals. Green branches left over exposed soils may reduce erosion. Small woody debris in the water can provide important habitat for small fish (fry) and aquatic amphibians, and may trap leaf litter and other detritus. Debris left on flood plains trap leaf litter and other detritus, which subsequently decomposes and enriches the soil. Evidence also suggests that small accumulations of woody debris may moderate fine sediment transport to downstream reaches. Large woody debris (>4 inches diameter and >1.5 times bankfull width in length) may provide important structural components to stream channels, trapping beds of gravel that are used by fish for spawning, and as habitat for aquatic invertebrates. Floodwater flowing around large woody debris scours pools, which become habitat for more abundant and larger fish. While Type Np and Ns Waters are not fish bearing by definition, woody debris in these waters are important for helping to abate excessive erosion during peak flows and for providing recruitment of debris which if eventually moved down stream may become beneficial structures for fish habitat in Type F and S Waters.

## SECTION 5 GUIDELINES FOR FOREST PRACTICES HYDRAULIC PROJECTS

<b>PART 1. INTRODUCTION.....</b>	<b>2</b>
<i>Figure 1 Washington Department of Fish and Wildlife contact information.....</i>	<i>3</i>
<i>Figure 2 Washington Department of Natural Resources contact information.....</i>	<i>4</i>
<b>PART 2. FISH PROTECTION STANDARDS .....</b>	<b>4</b>
<b>PART 3. GUIDELINES FOR APPLICATION PREPARATION.....</b>	<b>5</b>
3.1 PRE-APPLICATION CONSULTATION .....	6
3.2 CONSIDERATIONS BEFORE COMPLETING AN APPLICATION.....	6
<i>Table 1. Best Management Practices (BMPs).....</i>	<i>7</i>
<b>PART 4. WATER CROSSING STRUCTURES IN TYPE S AND F WATERS.....</b>	<b>8</b>
4.1 BASIC APPLICATION INFORMATION FOR FPHPs INVOLVING TYPE S AND F WATERS .....	9
<i>Figure 3 Plan view.....</i>	<i>9</i>
<i>Figure 4 Culvert cross section view.....</i>	<i>10</i>
<i>Figure 5 Channel profile view .....</i>	<i>10</i>
4.2 STREAM AND CHANNEL ASSESSMENT.....	11
<i>Figure 6 Culvert invert below expected regrade .....</i>	<i>13</i>
<i>Figure 7 Perched culvert .....</i>	<i>14</i>
<i>Figure 8 Pebble count procedure .....</i>	<i>15</i>
4.3 CONSTRUCTION BMPs.....	16
<i>Figure 9 Typical bypass pump.....</i>	<i>18</i>
4.4 MITIGATING FOR UNAVOIDABLE IMPACTS FOR TYPE S AND F WATER CROSSINGS.....	21
4.5 CULVERT DESIGN.....	22
4.5.1 Culvert installation .....	22
4.5.2 Culvert design options .....	22
4.5.2.1 No-slope design.....	22
<i>Figure 10 Design elements of a no-slope culvert .....</i>	<i>23</i>
<i>Figure 11 No-slope minimum culvert width guideline .....</i>	<i>24</i>
<i>Figure 12 Culvert inlet area remaining versus percent of countersink.....</i>	<i>25</i>
4.5.2.2 Stream-simulation design.....	25
<i>Figure 13 Profile and cross sections for typical stream-simulation culverts for .....</i>	<i>26</i>
<i>low to moderate gradient settings.....</i>	<i>26</i>
<i>Figure 14 Profile and cross sections for typical stream-simulation culverts for .....</i>	<i>27</i>
<i>higher gradient settings .....</i>	<i>27</i>
4.5.2.3 Hydraulic Design .....	27
4.5.2.4 Alternative Design Methods.....	28
4.5.3 Culvert Retrofitting .....	28
4.6 BRIDGES.....	28
<i>Figure 15 Bridge cross section over a confined channel showing the relationship between .....</i>	<i>30</i>
<i>the channel bed width and the recommended width between abutment protections. ....</i>	<i>30</i>
4.7 FORDS IN TYPE S AND F WATERS .....	30
<b>PART 5. WATER CROSSING STRUCTURES IN TYPE N WATERS .....</b>	<b>32</b>

5.1 CULVERT DESIGN..... 32  
*Table 2. Three methods to size Type N Water culverts..... 33*  
*Table 3. Method A, culvert sizing table for Type N Waters..... 34*  
*Table 4. Three ways to estimate the 100-year flood level to be used with Method C Hydraulic Design..... 36*  
*Figure 16 Nomograph for calculating sizes for round corrugated metal culvert pipe on Type N waters..... 37*  
5.2 CONSTRUCTION BMPs FOR CULVERTS AND BRIDGES ..... 37  
*Figure 17 Design to prevent culvert plugging hazard..... 38*  
*Figure 18a Armored relief dip design ..... 39*  
*Figure 18b Armored Relief Dip Design..... 40*  
5.3 FORDS IN TYPE N WATERS ..... 41  
**PART 6. WATER CROSSING STRUCTURE MAINTENANCE AND REPAIR ..... 42**  
**PART 7. TEMPORARY CULVERTS..... 43**  
**PART 8. WATER CROSSING REMOVAL AND ABANDONMENT..... 44**  
*Figure 19 Plan view of road crossing abandonment showing excavation of road fill and placement of large wood when it is available on site and non-merchantable..... 46*  
*Figure 20 Profile view of road crossing abandonment showing the overall drop in water surface..... 46*  
*Figure 21 Stream profiles at road crossing abandonment sites..... 47*  
*showing two regrade treatments..... 47*  
**PART 9. FISH CAPTURE AND EXCLUSION..... 48**  
**PART 10. OTHER COMMON HYDRAULIC PROJECTS ..... 51**  
10.1 BEAVER DAM REMOVAL..... 51  
10.2 LOGGING CABLE SUSPENSION ACTIVITIES ..... 52  
10.3 LARGE WOOD PLACEMENT, REMOVAL, AND REPOSITIONING ..... 53  
10.4 STREAM BANK PROTECTION ..... 54  
10.5 OTHER HYDRAULIC PROJECTS ..... 56  
**GLOSSARY..... 58**  
**RESOURCES ..... 60**

**PART 1. INTRODUCTION**

The 2012 Washington State Legislature amended laws to integrate hydraulic projects associated with forest practices into forest practices application (FPA) review and approval.

As amended, RCW 76.09.040 directs the Forest Practices Board to:

- Incorporate applicable fish protection standards from the hydraulic code rules into the forest practices rules; and
- Establish and maintain technical guidance in the forest practices board manual to assist with implementation of those fish protection standards.

The resulting rules for s (FPHPs) can be found in chapters 222-12, 222-16, 222-20, 222-24, 222-30, 222-34, and 222-50 WAC. This board manual section contains the required technical guidance.

The guidelines in this board manual section are provided to help forest landowners and managers plan and design hydraulic projects that will protect *fish life* and water quality. However, they will not address every situation. You are encouraged to consult with the Department of Natural Resources (DNR) and the Washington Department of Fish and Wildlife (WDFW) while planning projects to make sure you are considering and addressing all important factors on a particular site. DNR and WDFW contact information is shown on the region maps in figures 1 and 2 below. Tribes may be consulted for additional expertise.



Figure 1 Washington Department of Fish and Wildlife contact information

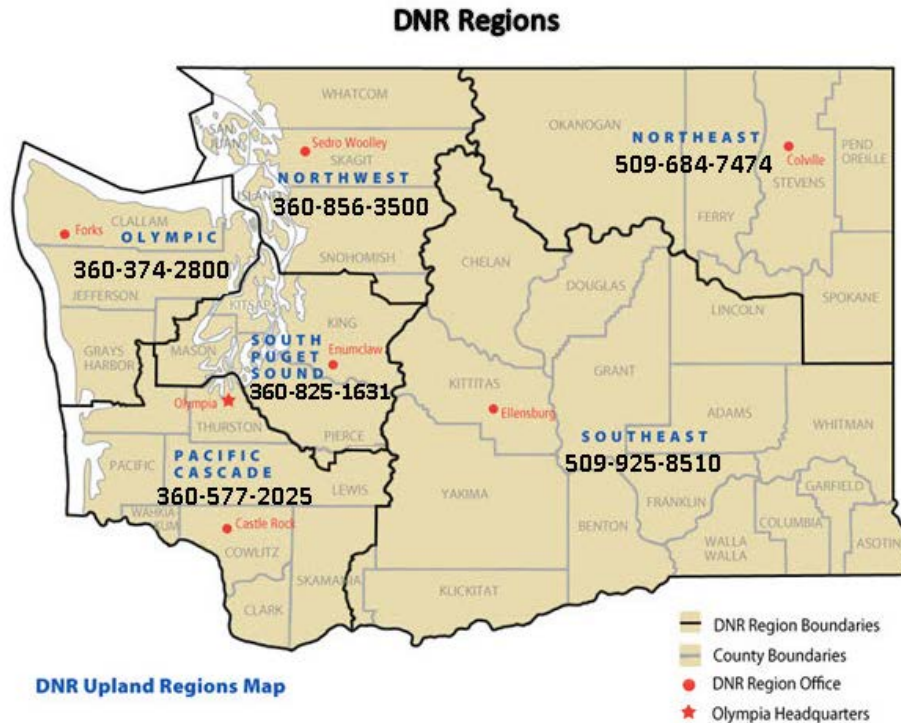


Figure 2 Washington Department of Natural Resources contact information

Certain technical terms throughout the guidance are defined in the glossary on pages B5-57 and B5-58. Each is italicized once per major part. For guidance on forest practices road construction and maintenance, please see Board Manual Section 3 Guidelines for Forest Roads.

**PART 2. FISH PROTECTION STANDARDS**

Fish protection standards are included in forest practices rules for specific FPHP types. The primary objectives of the fish protection standards are to:

- Protect *fish life*;
- Achieve *no-net-loss* of productive capacity of fish or shellfish habitat;
- Minimize project-specific and cumulative impacts to fish life; and
- Mitigate for unavoidable impacts from FPHPs to fish life and fish habitat.

Using the best management practices (BMPs) in this manual will increase the likelihood that your project will achieve the standards and result in approval of your application.

In general, you will need to:

- Restrict and mitigate for any disturbances from FPHPs to the existing stream channel, banks, and riparian vegetation;
- Preserve spawning and rearing habitat (examples: preserving recruitment and transport of bed load and large woody material downstream; preserving opportunities for natural rates of channel migration within the floodplain);
- Preserve fish life during the project;
- Preserve water quality and unobstructed flow;
- Ensure free and unimpeded adult and juvenile fish passage; and
- Design and maintain structures to withstand the *100-year flood level*.

### Mitigation

“Mitigation”, as defined in WAC 222-16-025, means actions required as provisions of FPHPs to avoid or compensate for impacts to fish life resulting from the proposed project activity.

Mitigation is achieved for most FPHPs in the forested environment through the proper use of forest practices rules and BMPs in this board manual section. Additional mitigation may be required for site-specific unavoidable impacts depending on the nature of the project. Therefore, DNR and WDFW should be consulted prior to FPA submittal. Affected tribes will also review proposed activities and can provide helpful technical input for minimizing and mitigating for unavoidable impacts to fish life or habitat.

The type(s) of mitigation required will be considered, and implemented where feasible in the following sequential order of preference:

- 1) Avoiding the impact altogether by not taking a certain action or parts of an action;
- 2) Minimizing impacts by limiting the degree or magnitude of the action and its implementation;
- 3) Rectifying the impact by repairing, rehabilitating, or restoring the affected environment;
- 4) Reducing or eliminating the impact over time by preservation and maintenance operations during the life of the action;
- 5) Compensating for the impact by replacing or providing substitute resources or environments; or
- 6) Monitoring the impact and taking appropriate corrective measures to achieve the identified goal.

For projects with potentially significant impacts, a mitigation agreement may be required prior to approval.

Possible unavoidable impacts and potential mitigation measures to compensate for those impacts are found for particular FPHPs within this manual (site restoration, beaver dam removal, logging cable suspension, and stream bank protection). The activities, possible impacts, and potential mitigation alternatives are not comprehensive but can be used to guide the development of proposals. Potential mitigation measures are best formulated and determined on site. Alternative mitigation measures not listed for particular FPHPs in this manual may also be deemed necessary on a case by case basis.

Consider the following points during the development of compensating mitigation proposals:

- Utilizing onsite materials where they are available and provide adequate function.
- Capitalizing on operational efficiency by implementing compensating mitigation measures in the same time period as the project.
- Coordinating early and often with DNR, WDFW, and affected tribes to plan for site-specific conditions.

### **PART 3. GUIDELINES FOR APPLICATION PREPARATION**

The purpose of this part is to help applicants prepare and complete applications that include an FPHP. FPA instructions specify the required information for FPHPs. The instructions are available at

[http://www.dnr.wa.gov/BusinessPermits/Topics/ForestPracticesApplications/Pages/fp\\_forms.aspx](http://www.dnr.wa.gov/BusinessPermits/Topics/ForestPracticesApplications/Pages/fp_forms.aspx).

FPA review time for applications that include FPHPs is described in detail in WAC 220-110-085, WAC 222-20-017, and WAC 222-20-020. FPAs containing the following types of FPHPs will take up to 30 additional days for approval or disapproval:

- Culvert installation or replacement, and repair at or below the *bankfull width* in fish bearing streams that exceed five percent gradient;
- Bridge construction or replacement, and repair at or below the bankfull width of fish bearing *unconfined streams*;
- Fill within the 100-year flood level of unconfined fish bearing streams.

The additional time for these FPHPs is required for concurrence review by WDFW. During the concurrence review, WDFW may contact the applicant requesting clarification or additional information, or to discuss changes to the project designs provided in the application to improve compliance with fish protection standards. The consultation process is limited to a maximum of 30 days, and therefore thorough planning is critical and pre-application consultation is encouraged.

### **3.1 Pre-application consultation**

Landowners are encouraged to consult with WDFW biologists and DNR forest practices foresters prior to submitting an FPA to ensure project plans and specifications meet fish protection standards. Tribes may also be consulted for additional expertise.

Pre-application consultation should take place well before submitting an FPA to DNR. It will save time in the long run and increase the likelihood of approval.

### **3.2 Considerations before completing an application**

FPHP design often depends on the water type; therefore, you should verify the water type with DNR prior to submitting an application.

FPHPs involving construction in fish bearing or flowing waters are usually conducted during times of low summer flow conditions outside of fish migration, spawning and incubation periods. Timing is site-specific and varies by fish species and stream location. Therefore, it is critical to contact WDFW for specific guidance on project timing.

If an FPHP is proposed for a Type S Water, any requirements of the local government's shoreline master plan must be reflected in the FPA; if the local government requires a Substantial Development Permit, a copy of the permit must be included with the FPA.

You should also determine:

- Your proposed start and end date;
- How the work will be sequenced; and
- All equipment that will be needed and how it will be used.

Depending on the potential impacts to *fish life* and water quality, all hydraulic projects will involve some combination of rule-required specifications and best management practices (BMPs) for the activities listed in Table 1. To prepare a complete plan, see Parts 4 through 10 as applicable to your project.

**Table 1. Best Management Practices (BMPs)**

<b>Project Activities</b>	<b>BMP Locations</b>	<b>Parts</b>
Controlling sediment and erosion	Water quality	4.3
	Equipment operation	4.3
	Dewatering	4.3
	Project site preparation	4.3
	Site restoration	4.3
	Culvert, bridge, ford installation and maintenance	4.5, 4.6, 4.7
	Water crossing structure maintenance and repair	6
	Temporary culverts	7
	Logging cable suspension activities	10.2
	Large wood placement, removal, and repositioning	10.3
	Stream bank protection	10.4
Clearing vegetation , minimizing disturbance, and replanting exposed areas	Project site preparation	4.3
	Equipment operation	4.3
	Site restoration	4.3
	Water crossing structure maintenance and repair	6
	Temporary culverts	7
	Water Crossing Removal and Abandonment	8
	Beaver dam removal	10.1
	Logging cable suspension activities	10.2
	Large wood placement, removal, and repositioning	10.3
Stream bank protection	10.4	
Operating and staging of heavy equipment	Water quality	4.3
	Equipment operation	4.3
	Project site preparation	4.3
	Site restoration	4.3
	Fords (Type N Waters)	5.3
	Water crossing structure maintenance and repair	6
	Beaver dam removal	10.1
	Large wood placement, removal, and repositioning	10.3
	Stream bank protection	10.4
Addressing oil or gasoline spills or leakages	Project site preparation	4.3
	Water quality	4.3
	Equipment operation	4.3
	Fords (Type N Waters)	5.3
	Water crossing structure maintenance and repair	6
Bypass methods to be used in flowing water	Dewatering	4.3
	Construction BMPs (Type N Waters)	5.2
	Water crossing structure maintenance and repair	6
	Fish capture and exclusion	9
Keeping fish life out of the work area, including fish capture and exclusion (Type S and F Waters only)	Fish capture and exclusion	9
	Dewatering	4.3
	Beaver dam removal	10.1
Ensuring fish passage after project completion (Type S	Culverts	4.5
	Bridges	4.6



Project Activities	BMP Locations	Parts
and F Waters only)	Temporary culverts	7
	Water crossing removal and abandonment	8
Considering the passage of woody debris and sediment (all typed Waters)	Culverts	4.5
	Bridges	4.6
	Construction (Type N Waters)	5.2
	Water crossing structure maintenance and repair	6

Alternatives to the BMPs in Parts 4 through 10 may be considered if they can be shown to meet or exceed fish protection standards. Alternative methods that haven't been demonstrated for their effectiveness in meeting fish protection standards are likely to require additional review.

**PART 4. WATER CROSSING STRUCTURES IN TYPE S AND F WATERS**

Whenever a roadway crosses a stream it creates some level of risk to fish passage, water quality, or specific aquatic or riparian habitats. Generally, the risk increases the more the roadway confines and constricts the channel and floodplain. When siting a water crossing structure, all practical alternatives should be investigated to prevent or minimize these risks. However, additional mitigation measures may be necessary to address unavoidable impacts from FPHPs to fish life and fish habitat.

**Family Forest Fish Passage Program (FFFPP)**

Small forest landowners may be eligible for the FFFPP, a state cost share program to help pay for fixing fish passage barriers. For information see *Family Forest Fish Passage Program* in Board Manual Section 3 Guidelines for Forest Roads, and go to [www.dnr.wa.gov/ffpp](http://www.dnr.wa.gov/ffpp), or contact any DNR region office.

When designed and constructed properly, water crossing structures in Type S and F Waters will protect fish life and habitat, and will meet fish protection standards by:

- Providing for unimpeded passage for all species of adult and juvenile fishes;
- Ensuring that the physical and biological characteristics of the natural stream channel are preserved throughout the water crossing structure, as well as the adjacent channel both upstream and downstream;
- Passing the *100-year flood level*; and
- Providing opportunity for passage of expected bed load and associated large woody material likely to be encountered during flood events.

Starting your design planning process with a site assessment will help you determine the appropriate water crossing structure for your site. The two primary options for water crossing structures are bridges and culverts. The appropriate option depends on the size and configuration of the stream channel; the size, character, location, and elevation of the watershed; and the frequency and timing of use. Generally, bridges are the preferred structure to ensure free and unimpeded fish passage, culverts are used to cross smaller streams, and fords are used for temporary purposes under limited circumstances.

For more information on culvert design, please see the guidelines in the WDFW publication, *Design of Road Culverts for Fish Passage* (Bates et al. 2003), which can be found at <http://wdfw.wa.gov/publications/00049/>.

**4.1 Basic Application Information for FPHPs Involving Type S and F Waters**

Applications that include FPHPs require the following basic information:

- Vicinity map and other drawings that show the project in relationship to the *channel bed width* or the channel migration zone, whichever is greater, and the 100-year flood level if a floodplain exists at the project location.
- If possible, the GPS-derived location for the project site expressed in terms of decimal degrees.
- Accurate drawings with dimensions of the plan view, cross section view, and channel profile view. Examples are shown in figures 3, 4, and 5.
- Establish and show the location of benchmarks, also known as reference points, at the project site as identified on the site plan. These are typically used to establish exact critical elevations and locations relative to the design plan and channel survey for upstream and downstream culvert elevation (*invert*), bottomless culvert footings, bridge abutments, etc. The reference points need to be durable and located on persistent objects like old growth stumps, large trees, or boulders that will survive the construction activity, and durable enough to facilitate post-project monitoring.

Figures 3, 4, and 5 are examples of a plan view, culvert cross section view, and channel profile view.

- The plan view shows a crossing structure in relation to road and stream alignment;
- The culvert cross section view depicts a crossing structure perpendicular to the axis; and
- The channel profile view shows the lengthwise dimensions of the crossing structure.

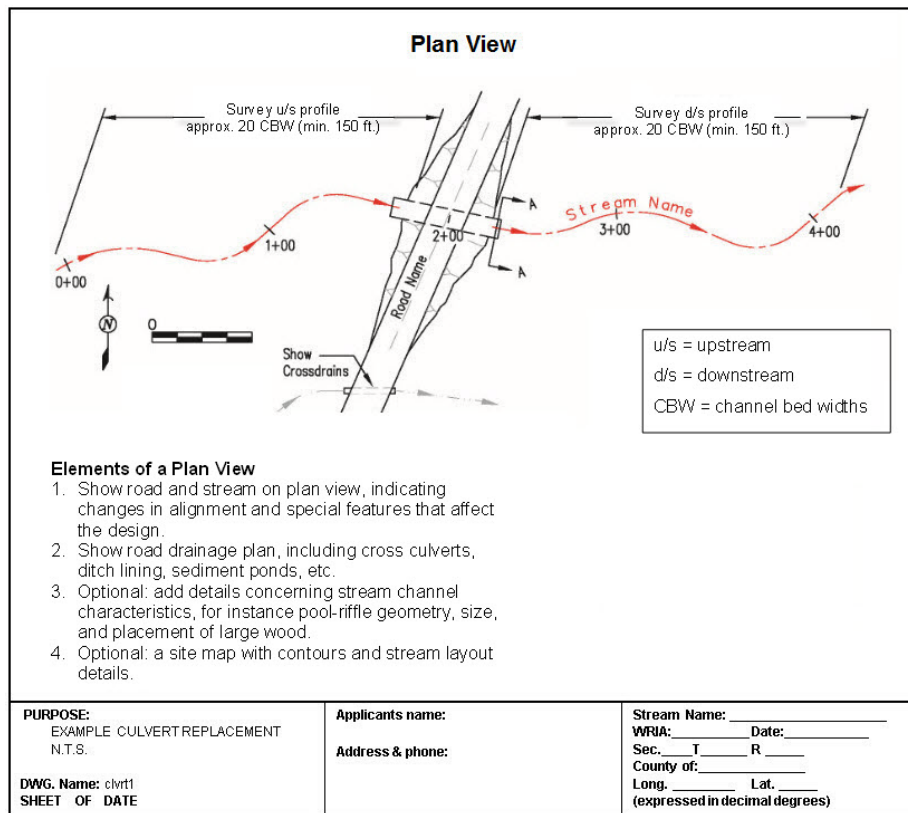


Figure 3 Plan view

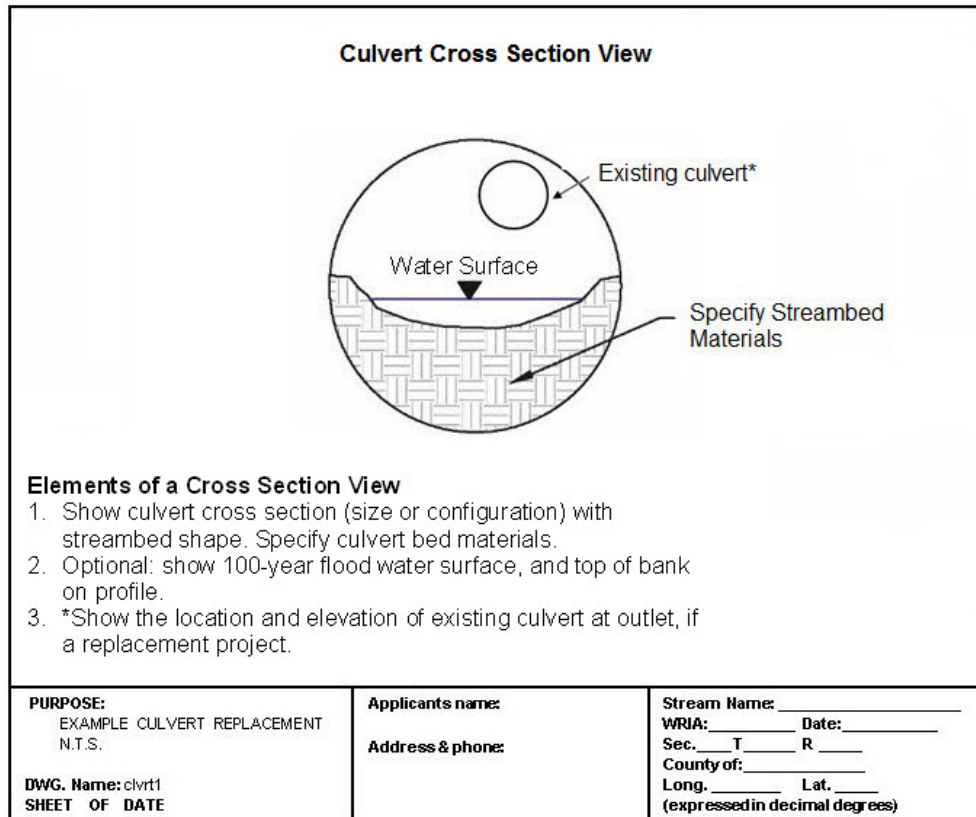


Figure 4 Culvert cross section view

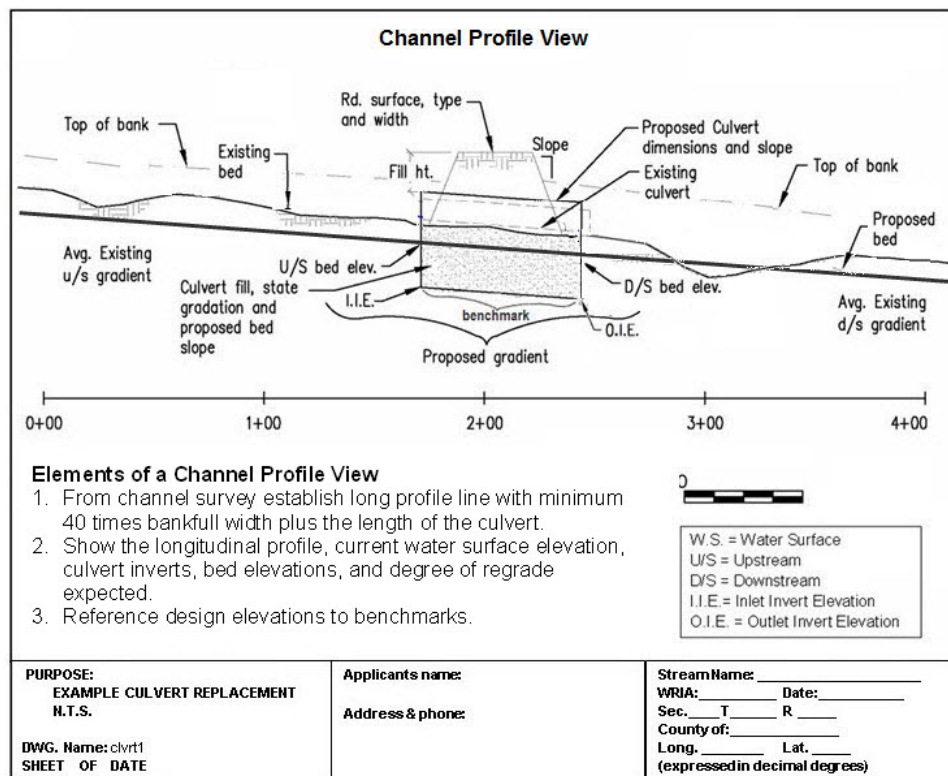


Figure 5 Channel profile view

## **4.2 Stream and Channel Assessment**

Before designing a water crossing, you should verify the water type with DNR. Please refer to the water type definition in WAC 222-16-031, and refer to Board Manual Section 13 Guidelines for Determining Fish Use for the Purpose of Typing Waters.

The following stream characteristics should be assessed to determine an appropriate water crossing design:

- channel bed width/channel migration zone
- channel profile
- channel pattern
- vertical and horizontal channel stability
- condition of channel banks
- sediment transport and deposition
- potential debris loading and transport
- hydrology and hydraulics (watershed size, location, elevation, rain-on-snow zone, anchor ice, ice jams, etc.)

Part 4.2 provides concise information on stream characteristics and their relevance to a water crossing design. You can get help from WDFW to determine the scope of the evaluation necessary for your site. You may also refer to the WDFW publication, *Integrated Streambank Protection Guidelines* (Cramer et al. 2003) at <http://wdfw.wa.gov/publications/00046/wdfw00046.pdf> for in-depth guidelines on site assessments.

### **Channel bed width/channel migration zone**

The channel bed width of a stream is by far the most important parameter in any crossing design. Accurate measurements are critical for a successful project. The method for determining channel bed width is described below and the methods for determining whether a channel migration zone is present can be found in Board Manual Section 2 Standard Methods for Identifying Bankfull Channel Features and Channel Migration Zones.

**Channel bed width**, as defined here, is the stream's width metric for FPHPs involving Type S and F Waters. *Bankfull width* is to be used as the stream width metric for FPHPs involving Type N Waters.

The channel bed width is defined as the width of the bankfull channel. The bankfull channel is defined as the stage when water just begins to overflow into the active floodplain. However, determining bankfull width requires the presence of a floodplain or bench, and depending on physical or geographical conditions, some streams have neither. When determining bankfull channel width for a stream where a floodplain or distinct bench is not present, features used in the general descriptions of active channel and ordinary high water will aid the project designer in determining channel bed width.

“Active channel width” is used to describe the stream's recent or current discharges. Outside the active channel are indicators, such as soil development and permanent vegetation, which show stability and that overland flow is rare. Inside the active channel are features indicating normal stream flow processes such as sediment deposits and bed scour. The upper limit of the active channel may occur at a “break” in slope separating a steeper active slope and a gentler upland slope.

“Ordinary high water line” is usually identified by physical scarring along the bank or shore and the action of water so common that it leaves a natural line impressed on the bank. The line may be indicated by erosion, benching, change in soil characteristics, lack of terrestrial vegetation or the presence of vegetative litter or woody debris. Soil characteristics or seasonal vegetation may make finding the high water line difficult and several locations should be observed to ascertain the correct location of the high water mark.

The following features, taken from the descriptions of active channel width and ordinary high water line, can be used for measuring channel bed width when a floodplain or bench is not present:

- changes in vegetation or a lack of vegetation (especially the lower limit of perennial species);
- changes in slope or topographic breaks along the bank;
- changes in the particle size of bank material, such as the boundary between coarse cobble or gravel with fine-grained sand or silt;
- the presence of bank undercutting, which usually reaches an interior elevation slightly below the bankfull stage;
- the height of depositional features, especially the top of the point bar, which defines the lowest possible level for bankfull stage; and/or
- stain lines/marks or the lower extent of lichens on boulders.

Landowners and project designers are encouraged to use a combination of the indicators listed above to more accurately estimate the channel bed width. Since stream anomalies, drought, flooding, or seasonal vegetation can mask or accentuate the targeted channel bed width, it is recommended that applicants observe several locations when measuring the channel bed width to achieve an accurate calculation.

### Channel profile

The channel profile is a longitudinal profile view along the length of the stream. An example is shown in Figure 5. It is critical for culvert design and forms the basis for the plan. It is developed by surveying the elevation of the bed or water surface along the stream reach that includes the water crossing, typically at least 200 feet upstream and downstream from the water crossing site.

The channel profile is used to determine stream slope, degree of upstream and downstream incision and deposition, the depth of pools, and the presence of *nick points*. Water surface measurements should be taken at the same flow level. The channel profile helps to determine the appropriate slope and elevation of the culvert and the strategy for dealing with channel regrade, including deposition, and incision. Channel elevation may respond when an existing in-stream structure is removed during the installation of a new crossing structure. Outfall drops and locally steepened sections immediately adjacent to the crossing structure are hallmarks of channel incision. Figure 6 shows the culvert invert, which is the bottom of the culvert at the inlet and outlet end, and which must be below the expected regrade line with an additional allowance for the necessary countersink.

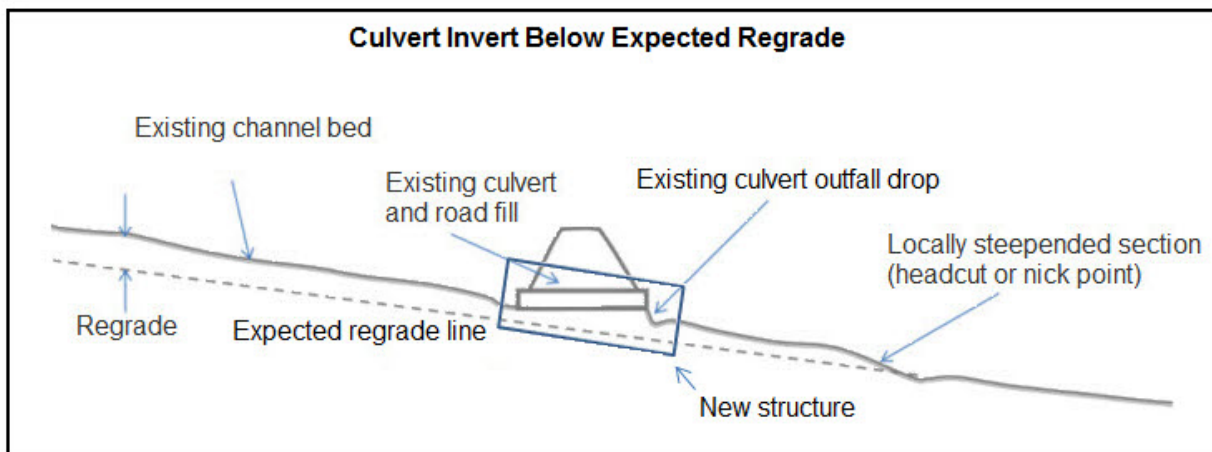


Figure 6 Culvert invert below expected regrade

### Channel pattern

Recognizing the type of channel pattern is essential for the selection of an appropriate water crossing structure. Stream processes form variable channel patterns. The most common channel pattern type associated with culvert crossings is a confined, non-meandering channel. This greatly simplifies the analysis because these channels, if stable, experience limited lateral channel movement and have a limited floodplain. Unconfined alluvial channels are characteristic of channel migration zones and are more complicated because they tend to experience more lateral channel migration and larger floodplains. Please see Board Manual Section 2 Standard Methods for Identifying Bankfull Channel Features and Channel Migration Zones. Part 2.5 of Section 2 includes a technical discussion describing how riverine processes form channels; and 2.1 through 2.4 provide standard methods to identify whether a channel migration zone exists. It is recommended that DNR and WDFW be consulted when these complicated channel types are encountered. Tribes may also be consulted for additional expertise.

### Channel stability

Channel stability can vary greatly along a stream course. To the greatest degree possible, stream crossings should be placed in locations of high channel stability. Channel characteristics indicating stability include:

- Straight segments with no evident signs of recent bank erosion;
- A single channel with minimal floodplain and no high flow channels;
- Relatively coarse streambed material such as cobbles or boulders;
- The absence of sediment deposits such as significant gravel and sand bars that are exposed at low flows; and
- The absence of “stair step” features in the streambed within at least 200 feet of the crossing location.

Aligning the crossing structure at right angles to a relatively straight stream course can minimize the length of the structure (and the length of affected stream channel) and avoid the potentially destabilizing effects of forcing the channel through abrupt changes in direction and elevation.

### Condition of channel banks

The condition of a channel’s banks is indicative of channel stability. Raw, vertical banks are a sign of recent incision (cutting or vertical degradation) and may be a reason to increase the estimate of channel width to accommodate future channel widening. The channel may also continue to incise, forcing the design to a bridge or a more deeply countersunk culvert to accommodate the additional downcutting. Removing the existing culvert, if perched, may result in upstream incision and possible impacts to habitat and channel conditions. Figure 7 shows a perched culvert.

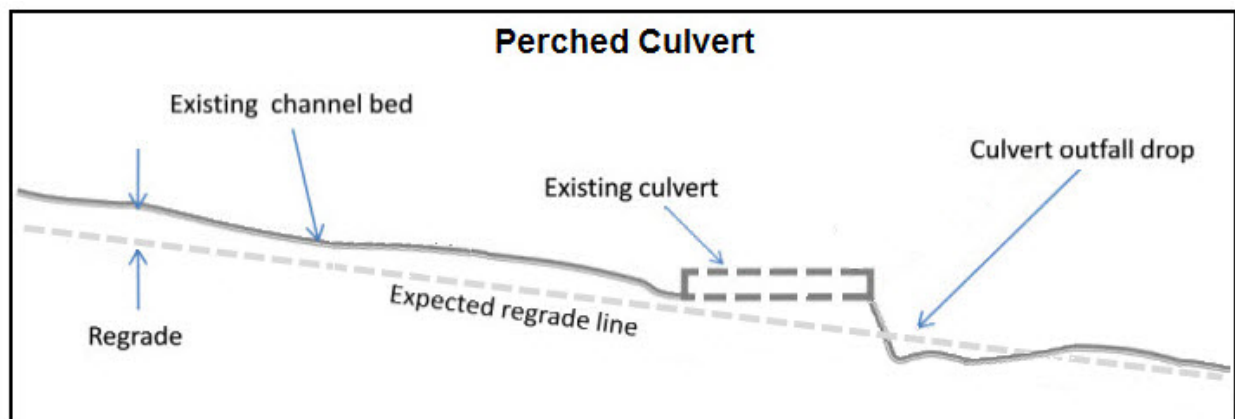
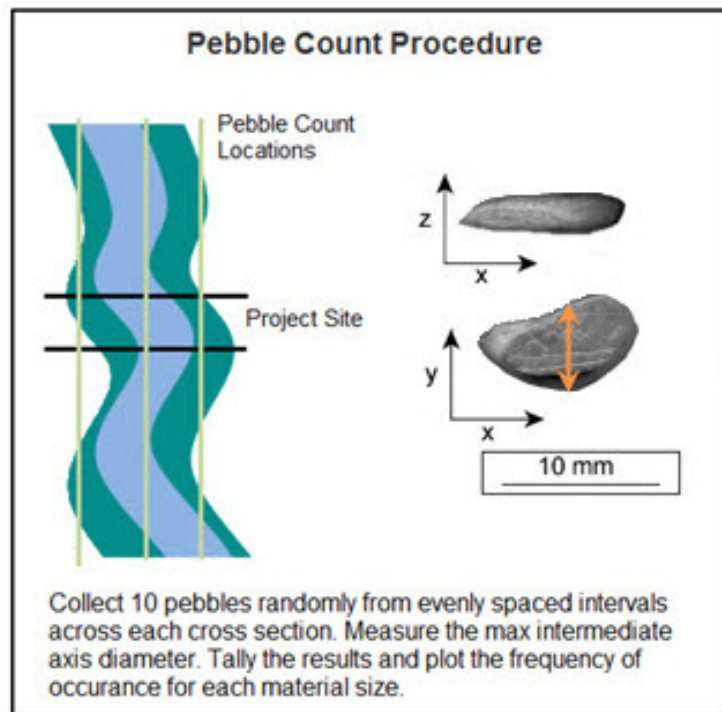


Figure 7 Perched culvert

Very low banks or no banks at all indicate heavy *aggradation*. The crossing is likely located at a gradient break or on an unconfined channel. This is a very challenging condition and the stream, without the road crossing determining the location of the channel, would move laterally to lower ground. Maintaining a static location often leads to designing a larger crossing to accommodate the sediment load, raising the road to allow sediment to build and scour, or using of alternative methods to maintain the crossing. For more information regarding alternative methods, please see the WDFW website at <http://wdfw.wa.gov/conservation/habitat/planning/ahg/>, Aquatic Habitat Guidelines.

### Sediment transport and deposition

Sediment deposition, supply, and transport must be considered in selecting an appropriate water crossing structure. The resulting streambed at the crossing must be similar to the streambed upstream and downstream of the structure. Streambed composition can be measured in a variety of ways. See Figure 8. Another source of information on pebble count is available on the West Virginia Department of Environmental Protection website at <http://www.dep.wv.gov/WWE/getinvolved/sos/Pages/SOPpebble.aspx>.



*Figure 8 Pebble count procedure*

Depositional areas, such as alluvial fans or where the channel gradient transitions from steep to flat, pose additional design considerations. A channel spanning bridge may be a better choice than a culvert for a stream crossing location with high sediment supply and deposition. A culvert located in a depositional reach may be overwhelmed with sediment, making it dysfunctional.

Similarly a channel spanning bridge may be a better choice for stream crossing locations with limited sediment supply where a culvert installation may eventually erode the outfall and result in the loss of fish passage.

### Potential debris loading and transport

Large woody debris (LWD) is an important ecological and habitat-forming component in fish bearing streams, and serves as a sediment retention mechanism in fish and non-fish bearing streams. LWD includes boles, root wads, and whole trees. Delivery of LWD into the stream depends on factors such as tree proximity, lean and direction, and the degree and evenness of forest cover. Transport of LWD is dependent on the size and power of the stream. The potential debris loading and transport in the vicinity of the water crossing structure needs to be considered in order to design the proper size structure.



### Hydrology and hydraulics

Water crossing structures should be designed to pass ice, debris and sediment likely to be encountered at the 100-year flood level. Bridges should have at least three feet of clearance between the bottom of the bridge structure and the water surface at the 100-year flood level. A clearance greater than 3 feet is typically necessary in locations of high transport of sediment and/or wood, or in locations where sediment and wood accumulate.

When designing a stream crossing, it is important to gather precipitation, forest hydrology, and peak flow data pertinent to the behavior of the stream. Hundred-year flood flows can be determined with gage data or regression analysis, allowing the determination of design discharge values. Methods to determine culvert sizing based on the 100-year flood level can be found in Part 5.1 Culvert Design. Also, it is important to consider the low flows in the channel to assure fish passage through the area of the water crossing structure. At the site of a structure it is essential to know the discharge and its variation over time.

### Important considerations

Design crossings to allow for natural stream processes, including the transport of wood, water, and sediment, while maintaining the natural movement pattern of the stream.

- Cross streams at right angles to the natural flow of the stream. Avoid critical areas such as wetlands and spawning habitat.
- Avoid reaches showing signs of channel instability.
- Avoid areas that require constraining, re-aligning, or altering the natural channel.
- Consider possible mitigation measures for unavoidable impacts from FPHPs to fish life and fish habitat.

If you have a difficult situation such as a channel with no discernible channel bed width, a road that crosses a delta or high depositional area, or a tidal crossing, consider:

- Moving the crossing upstream of depositional area.
- Oversizing the culvert crossing or using a bridge to accommodate sediment deposition.
- For bridges, raising the crossing to allow for deposition and transport of wood and debris.
- Proposing an alternative design such as a ford or *vented ford*.

Finally, pre-application consultation with DNR and WDFW will help you evaluate and plan for construction or removal of your water crossing structures. Please refer to Part 1 for DNR and WDFW contact information. Tribes may also be consulted for additional expertise.

### **4.3 Construction BMPs**

Use of the following BMPs during the construction of water crossing structures will minimize potential impacts to fish, fish habitat, water quality, and the riparian environment.

#### Project Site Preparation BMPs

- Minimize clearing limits associated with site access and construction to reduce disturbance of riparian vegetation, wetlands, and other sensitive channel features. Trimming and cutting is preferred to grubbing. Clearing limits for site disturbance should be clearly marked.
- Utilize established benchmarks for construction controls as described in Part 4.1.

- Establish staging areas (for construction equipment storage, vehicle storage, fueling, servicing, hazardous material storage, etc.) in a location and manner that will prevent erosion or contamination to typed waters.
- Prior to starting work in areas where the bank will be disturbed, install temporary erosion control measures such as a filter fabric fence or straw wattles to prevent sediment from entering the stream. During construction, cover erodible soils with a mulch or matting to prevent erosion, and slope erodible soils to route water into settling areas away from streams. Recommendations on the appropriate erosion control measures can be found in the Department of Ecology's stormwater management manuals at <http://www.ecy.wa.gov/programs/wq/stormwater/manual.html> (Western Washington); or <http://www.ecy.wa.gov/programs/wq/stormwater/easternmanual/manual.html> (Eastern Washington).
- After completion of work, but before removing the temporary erosion control measures, remove sediment accumulated during the project from behind the erosion control measures and deposit it in a location where it cannot enter typed water.

#### Fish capture and exclusion BMPs

Please see Part 9 for fish capture and exclusion BMPs. If personnel and resources are available, WDFW and affected tribes may assist with capturing and moving fish from the job site to free-flowing water. DNR can help identify affected tribes in a given area.

#### Dewatering BMPs

Construction site dewatering is often necessary to ensure the *protection of fish life* and habitat, as well as meet water quality standards. Dewatering of stream crossing construction sites is typically necessary because of potential impacts to the channel. Maintain clean water by diverting the stream before it enters the construction site and return the flow to the channel downstream from the project. Figure 9 illustrates this process.

- Passive gravity flow diversions are generally preferable to pumping. Pumps can be inefficient and unreliable, but may be necessary in some cases.
- Isolate the work area at both the upstream and downstream ends by placing coffer dams made of gravel filled bags, ecology blocks or a similar device and then diverting the flow around the work area before beginning any work in the channel.

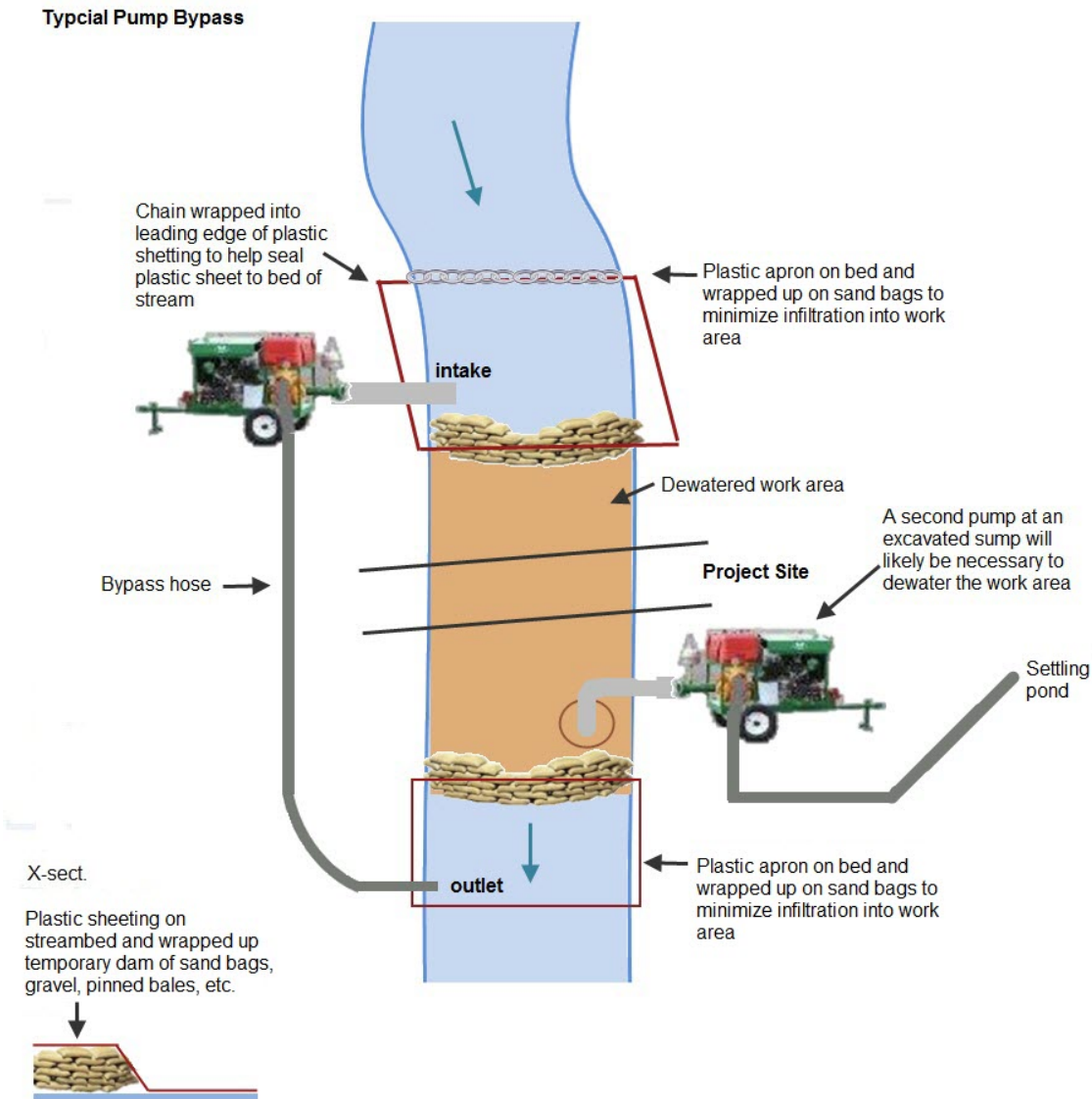


Figure 9 Typical bypass pump

- Cofferdams should be overlain with plastic or filter fabric on the upstream side to contain sediment. Accumulated silt should be removed with the filter fabric upon completion of the project.
- If gravel bags are used as coffer dams, after project completion the bags can be slit to allow the gravel to disperse downstream, provided the gravel is rounded and clean (e.g., pea gravel). Remove the bags and any associated debris from the site. If necessary, hand tools can be used to ensure stream flow and fish passage is not impeded by the gravel.
- Discharge clean diverted water back into the channel downstream as close as possible to the project site to maintain flows for fish and reduce the length of stream that needs to be dewatered.
- Stream beds typically have substantial subsurface water flow which must be captured and removed from the construction site. This dirty water (i.e., wastewater) cannot be discharged directly into typed waters. Install a *sump* within the work area for dewatering. Place pump

outlets upland a sufficient distance from the stream channel to allow the natural vegetation to filter sediments before waste water reaches the channel.

- Equip pumps used for dewatering the job site with screens to prevent injury of fish pursuant to RCW 77.57.010 and RCW 77.57.070. The pump intake must be screened by one of the following:
  - Perforated plate: 0.094 inch (maximum opening diameter)
  - Profile bar: 0.069 inch (maximum width opening)
  - Woven wire: 0.087 inch (maximum opening in the narrow direction)
- Ensure that the open area for all types of fish guards is a minimum of 27 percent and that the screened intake consists of a facility with enough surface area to ensure that the velocity through the screen is less than 0.4 feet per second.
- Keep the screen in place whenever water is withdrawn from the stream through the pump intake and maintain the screen to prevent injury or entrapment of juvenile fish.
- If pumps are used as the primary or secondary method of diverting flow around the isolated work area, plans should be in place for accessing additional backup pumps in the event of extremes in flow caused by weather or other factors. Once started, bypass pumps typically need to be run continuously through project completion. This requires 24 hour monitoring for refueling and pump maintenance. Pump failure is also common and requires backup pumps ready on site to replace the failed pump.



*Bypass pump*

#### Water quality BMPs

- Establish a site-specific spill prevention and erosion control plan prior to beginning work. Such a plan may include:
  - a site plan with a description of the methods of erosion/sediment control;
  - methods for confining, removing and disposing of excess construction materials;
  - measures for washing and maintaining equipment;
  - a spill containment plan;
  - measures to reduce and recycle hazardous and non-hazardous wastes; and
  - measures to disconnect road surface and ditch water from all typed waters (see BMPs in Board Manual Section 3 Guidelines for Forest Roads).
- Do not use wood that has been treated with creosote or pentachlorophenol for any part of the structure, including pilings, beams, structural supports, and decking. These components must remain free of these toxic substances for the duration of their functional lives. Detailed information about preservative options can be found on the Western Wood Preservative Institute web site at <http://www.wwpinstitute.org/aquatics.html>.
- Ensure that no chemicals or any other toxic or harmful materials are allowed to enter or leach into the stream.
- Minimize sediment delivery to typed water.

- Dispose of all project waste material such as construction debris, silt, excess dirt or overburden material above the limits of floodwater in an approved upland disposal site.
- Stop work if high flow conditions that may cause siltation are encountered during the project or if the coffer dams are compromised. Do not re-start work until the flow subsides.
- Do not allow uncured concrete or concrete by-products to enter the stream at any time during construction. Completely seal all forms used for concrete to prevent uncured concrete from getting into the stream.
- Ensure that all materials and equipment used for construction, monitoring, and fish salvage are free of aquatic invasive species. Decontaminate all materials and equipment so that no viable invasive species are transported to or from the job site.

#### Equipment operation BMPs

- Where practical, based on project scale and site conditions, accomplish the work by hand or with hand-held tools.
- Where possible, operate equipment from the road, road shoulder, bridge, top of the bank, dry gravel bar, work platform, or similar out-of-water location. Work within a dewatered channel or a channel with diverted flow is acceptable with the use of BMPs. In-water equipment operation should be avoided, but where necessary it should be identified and addressed in the spill prevention and erosion control plan.
- Check equipment daily for leaks and make any necessary repairs prior to commencing work activities along the stream. Ensure equipment is free of external petroleum-based products while working around the stream. Remove accumulations of soil or debris from the drive mechanisms (wheels, tires, tracks, etc.) and undercarriage of equipment prior to working near or in the stream.
- Equipment crossings of the stream are discouraged and should be proposed only when and where necessary to complete a project or access a project site.
- Operate equipment in the stream channel only if the drive mechanisms do not enter the channel or when the work area is dry or within an area where the stream flow is bypassed.
- Limit equipment use near the stream to specific access and work corridors to minimize disturbance to stream banks and vegetation. Service, refuel, and maintain equipment in an upland area to prevent contamination of surface waters. When practical, this service site should be located at least 200 feet from any receiving waters. Fueling areas should be equipped with sufficient spill containment supplies to prevent a spill from reaching typed waters.

#### Site restoration BMPs

Alteration or disturbance of the bank and vegetation should be limited to that necessary to construct the project. Trimming and cutting riparian vegetation is preferred to stump removal. Affected bed and bank areas should be restored to pre-project condition. This includes regrading and restoring banks and channel beds back to natural contours, removing unnecessary fill, controlling the potential for invasive species, revegetating disturbed areas with native vegetation, and restoring wood loading in the channel consistent with the rest of the stream.

- Place any trees cut during the project, that otherwise would be required to be left by forest practices RMZ rules, on the bank or in the stream to provide fish habitat and restore natural stream processes.

- Do not return in-stream flows to the project area until all in-channel work is completed and the banks are adequately stabilized to minimize sediment delivery to the stream or stream channel.
- Remove all structures, materials or equipment from the site and dispose of all excess spoils and/or waste materials properly upon completion of the project.
- Restore the channel bed, bank, and shoreline areas similar to their pre-project natural condition.
- When preparing a revegetation plan for the site, consider the precipitation zone, species native to the site, and the likelihood of natural revegetation.
- Site restoration includes replacing woody vegetation generally representative of the species and densities of adjacent undisturbed riparian vegetation. Plant a native erosion control grass seed mix immediately after construction to prevent future erosion, stem the invasion of noxious weeds, and stabilize the soil on any disturbed areas (see Board Manual Section 3 Guidelines for Forest Roads, Part 4.5 Vegetation BMPs). Spreading hay over the seed can help anchor the seed to the soil and reduce erosion.
- To the extent necessary to replace woody vegetation removed during construction, plant site-appropriate conifer or hardwood seedlings and/or transplant local shrubs no later than the fall or spring dormant periods following project completion. Generally, the replanting of woody vegetation should take place between October 31 and March 30.
- Where planting is needed, overplant, monitor, and maintain the plantings to assure that woody plant density is in compliance with the revegetation plan.

#### **4.4 Mitigating for unavoidable impacts for Type S and F water crossings**

- Possible impacts should be considered on site and may include:
  - Channel simplification resulting in loss of spawning and/or pool habitat.
  - Significant riparian stand removal or modification.
- Potential mitigation measures:
  - Installation of logs with root wads in the channel downstream of the new crossing is preferred. The intent is to install the largest functional pieces possible that would have otherwise contributed riparian function from a mature riparian stand. Conifer species such as Douglas fir or cedar provide habitat forming function in the stream for longer periods than hardwood species. Based upon stream size and existing riparian condition, strategies could include the following:
    - Installed wood should be a minimum of 12 inches diameter and 6 feet in length in streams under 4 feet channel bed width.
    - In streams over 4 feet channel bed width, installed wood should be a minimum of 12 inches in diameter and 1.5 times the channel bed width of the stream in length.
    - Wood should be placed so as to interact with stream flow.
    - Wood should be placed so as not to create fish passage barriers.
    - The total number of installed pieces should be determined on a case by case basis, and should be proportionate to the size of the affected stream.
  - In-channel work to restore channel geometry and substrate typical of undisturbed reaches.
  - Riparian replanting of disturbed areas with appropriate species.

## **4.5 Culvert Design**

Culverts installed in Type S and F Waters must be large enough to transport water, sediment, and wood likely to be encountered during all flows, up to and including *100-year flood* events. DNR and WDFW can help the landowner choose which culvert option is appropriate for the site.

### 4.5.1 Culvert installation

In this manual “culvert installation” includes culvert replacement projects.

If culverts are not installed and maintained properly, they have the potential to:

- Create fish passage barriers due to excessive stream velocities, headcuts upstream, or scouring downstream.
- Reduce downstream transport of sediment, LWD, and organic material resulting in decreased habitat complexity and food web productivity in downstream reaches.
- Alter natural channel forming processes.
- Disconnect floodplains and off-channel habitat.
- Damage the road and disrupt access.

### 4.5.2 Culvert design options

#### *4.5.2.1 No-slope design*

The no-slope culvert method is expected to pass fish when sized appropriately and installed on a flat gradient. It allows for the natural movement of bedload and a stable channel bed inside the culvert.

A no-slope culvert is designed to have the following characteristics:

- The culvert width is equal to or greater than the active channel width at the dimension where the culvert meets the streambed.
- The culvert is set at a flat zero slope gradient.
- The outlet invert (bottom of the culvert at the outlet or downstream end) is countersunk below the channel bed by a minimum of 20 percent of the culvert diameter or height.
- The inlet invert (bottom of the culvert at the inlet or upstream end) is countersunk by a maximum of 40 percent of the culvert diameter or height.
- The culvert has adequate capacity to accommodate the *100-year flood* flow and associated debris likely to be encountered.

The no-slope design option is usually applicable in the following situations:

- Small channels generally less than 10 feet channel bed width.
- New and replacement culvert installations in simple channel conditions.
- Low to moderate natural channel gradient (generally less than 3 percent slope but may be acceptable for higher stream gradients with appropriate countersink requirements and based on site specific conditions). The “generally less than 3 percent” recommendation gives the designer the option to use the no-slope method in a variety of rise and length combinations. Steeper slope channels generally require a deeper fill and a sloped culvert, i.e., stream simulation. Low energy stable streams that are over 3 percent may be appropriate for no-slope culverts. Pre-application consultation with DNR and WDFW is recommended for no-slope culvert designs in channel segments exceeding 3 percent gradient.

- Stream gradients up to 5 percent may be considered based on site-specific situations where the natural gradient of the stream can be maintained upstream and downstream of the installation of a culvert set at zero grade. No-slope culverts are not appropriate for high gradient channels. This is because an improperly installed culvert set at a slope less than the gradient of the stream can over steepen the upstream channel, often leading to a headcut that can degrade fish habitat, destabilize the channel, and release sediment that can bury the culvert. It can also deposit large quantities of sediment downstream resulting in channel impacts, bank erosion, and flooding.
- Streams with little evidence of instability (mass wasting, high sediment transport).
- Where site conditions permit a culvert width of at least 1.25 times the natural channel width upstream of the structure.
- Where the likelihood of upstream head cutting can be avoided.

The no-slope culvert option is appropriate where the channel gradient (percent slope) multiplied by the culvert length do not exceed 20 percent of the culvert height. In other words, the steeper the stream gradient, the larger and/or the shorter the culvert must be to fit within a no-slope design. This can be applied with a certain degree of flexibility around these limits, provided the necessary hydraulic engineering expertise is available to account for the implications of constricting the upstream end of the culvert with the accreted bed or by installing a larger culvert. Figure 10 illustrates the elements of a no-slope culvert design.

For more information on the no-slope culvert design, please see the guidelines in the WDFW publication, *Design of Road Culverts for Fish Passage* (Bates et al. 2003), which can be found at <http://wdfw.wa.gov/publications/00049/>.

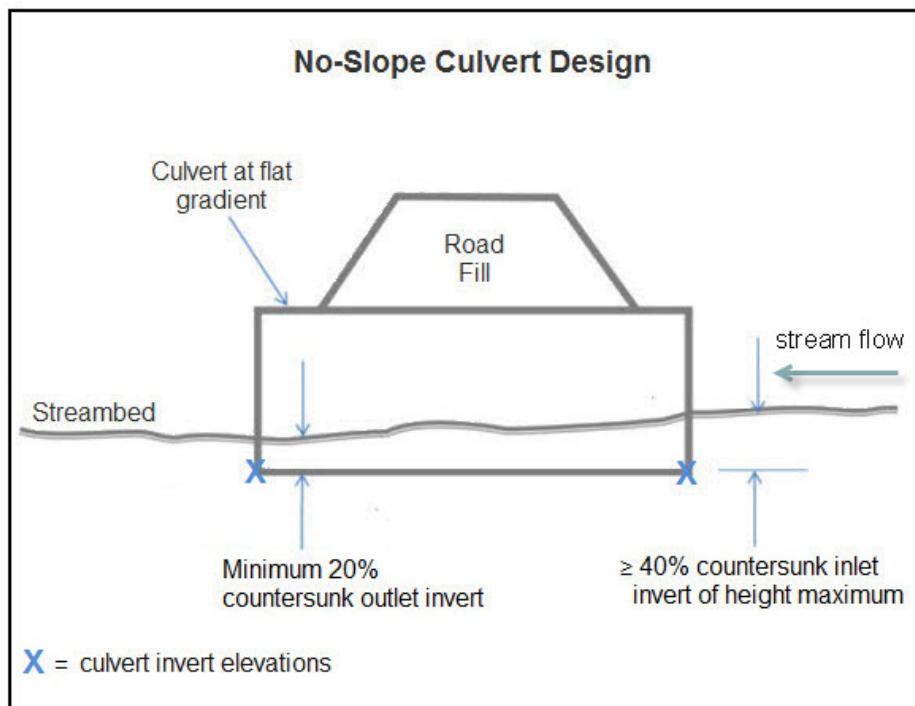


Figure 10 Design elements of a no-slope culvert



The culvert outlet invert must be countersunk a minimum of 20 percent of the culvert height (round culvert diameter or vertical measure of an arch, box or elliptical structure). Adequate culvert countersink is vital for proper performance and fish passage. When the stream gradient is low, it is recommended that the culvert be countersunk more so long as the inlet is not countersunk more than 40 percent. Inlet countersink designs greater than 40 percent may be appropriate under certain situations such as wetlands or wetland channels, where head cut is likely to occur that will flatten the stream gradient. The culvert outlet invert must be installed at the correct elevation relative to the downstream channel bed and overall channel profile. Since this outlet elevation is critical for any successful culvert design, it must be established and clearly benchmarked for post-project review prior to commencing any excavation for the project. While a full channel profile is not always necessary for new no-slope installations, it is critical for culvert replacements where the channel will adjust upon removal of the previous grade controlling structure. In all cases, the outlet invert must be accurately identified and surveyed prior to construction in order to establish a benchmark that relates to reference points outside of the project. This benchmark will confirm proper invert elevation and serve as post-project reference.

The width of the stream bed inside the culvert, based on the designed outlet countersink elevation, will be as wide as the average channel bed width of the streambed. The formula for the minimum culvert width to channel bed width is:

Minimum culvert diameter = 1.25 x channel bed width; conversely

Width at 20% countersink = 0.8 x culvert diameter

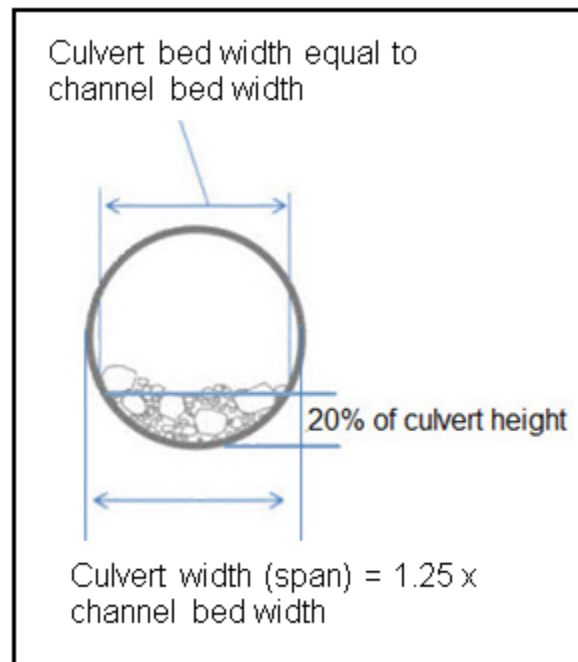


Figure 11 No-slope minimum culvert width guideline

The area at the inlet remaining open (above countersinking) must provide enough opening to pass the 100-year flood level with consideration for debris likely to be encountered (Figure 12). *Mitering* the culvert *inlet* may aid in peak flow and debris transport.

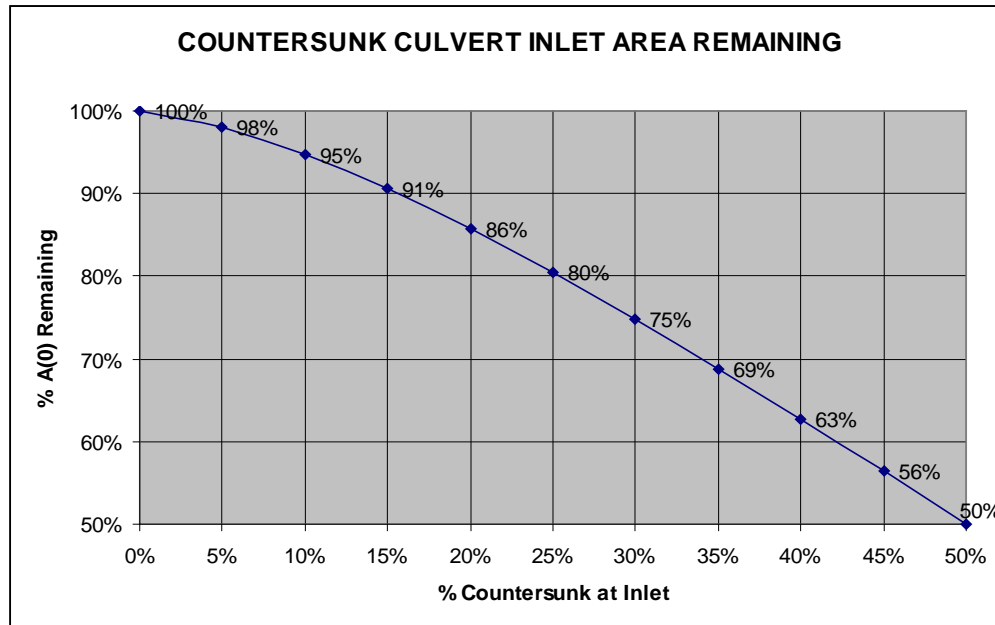


Figure 12 Culvert inlet area remaining versus percent of countersink

No-slope culverts countersunk deeper than 20 percent of the culvert height have the greatest possibility of providing for fish passage over the long term. Consider designing from the top-down (i.e., start at 40 percent/50 percent countersink at inlet, so the outlet countersink is maximized >20 percent). For no-slope culvert design with a countersink at or near 20 percent, or in high energy systems, there is a high likelihood of failure. The designer may want to consider a larger structure. Pre-application consultation is encouraged.

Culverts are filled with well-graded material consistent with the surrounding channel characteristics when natural processes are not expected to fill the culvert within two years (and there is no significant wedge of material upstream of crossing). No filling is required in wetland situations because the culvert will naturally backwater when set at proper elevations, which will provide pool habitat for fish species.

Pipe arches, also known as squashed pipes, need to be sized and designed to meet the above guidelines using the *Handbook of Steel Drainage & Highway Construction Products* from the American Iron and Steel Institute, 1994 edition, for geometry, sizing, and flow calculations.

#### 4.5.2.2 Stream-simulation design

The stream-simulation method is intended to mimic a stream channel, allowing for minor adjustments in response to changes in upstream and downstream channel dynamics. The structure is placed at or near the natural channel slope and incorporates natural substrate features that mimic the adjacent streambed, provide for fish passage, and allow for the natural transport of sediment, wood, and organic debris.

Generally, the stream-simulation option is an appropriate method in the following circumstances (Bates et al. 2003):

- New and replacement culvert installations.

- Complex settings, including sites with moderate to high natural channel gradient and/or sites requiring long culverts.
- Narrow stream valleys.
- Locations where passage is required for a broad range of aquatic species.
- Systems where passage must be provided for species with poorly understood requirements.
- Ecological connectivity; downstream transport of wood, sediment, and organic material is required.

Culverts designed to simulate streambeds are sized wider than the channel width, and the bed inside the culvert is sloped at a similar or greater gradient than the upstream channel stream reach (no more than 125 percent of the upstream gradient). This type of culvert is filled with substrate material that emulates the natural channel, erodes and deforms similar to the natural channel, and is unlikely to change the channel gradient unless specifically designed to do so.

The most basic stream-simulation culvert is a bottomless culvert placed over a natural streambed. Here, the natural streambed remains in place. More complex designs may involve substrate intermixed with immobile bedform elements (e.g., boulders) to maintain bed conditions within the structure. Typical low gradient and high-gradient stream-simulation schematics are shown in figures 13 and 14.

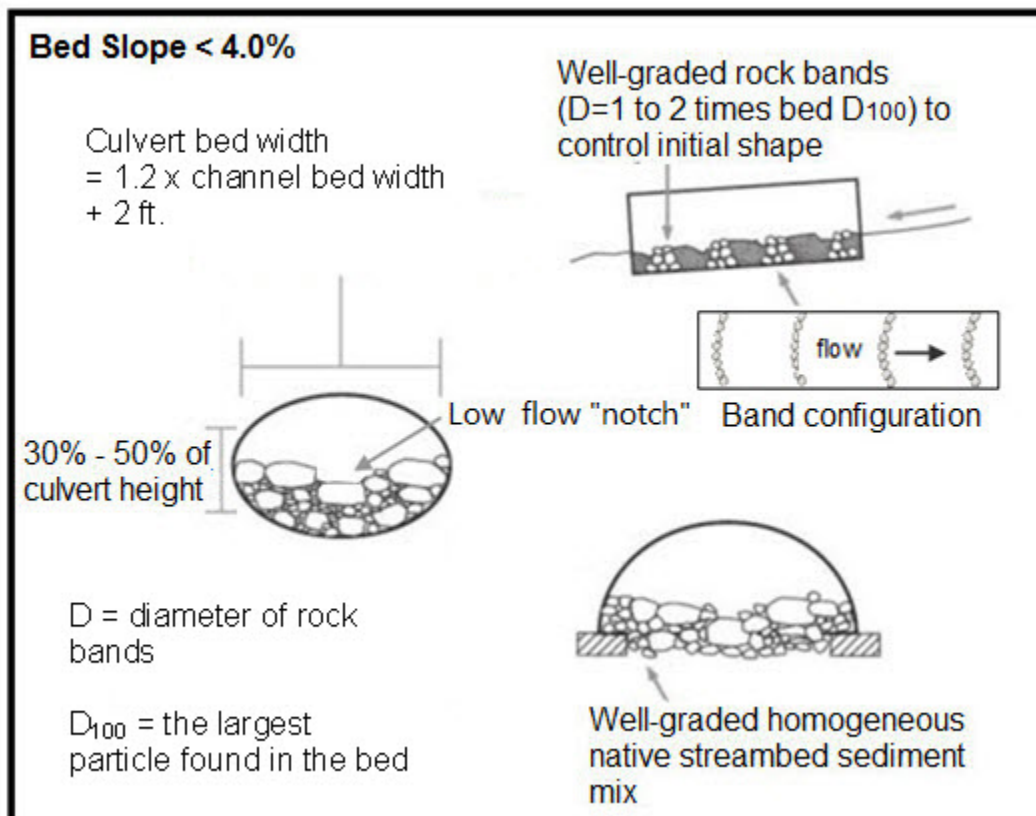
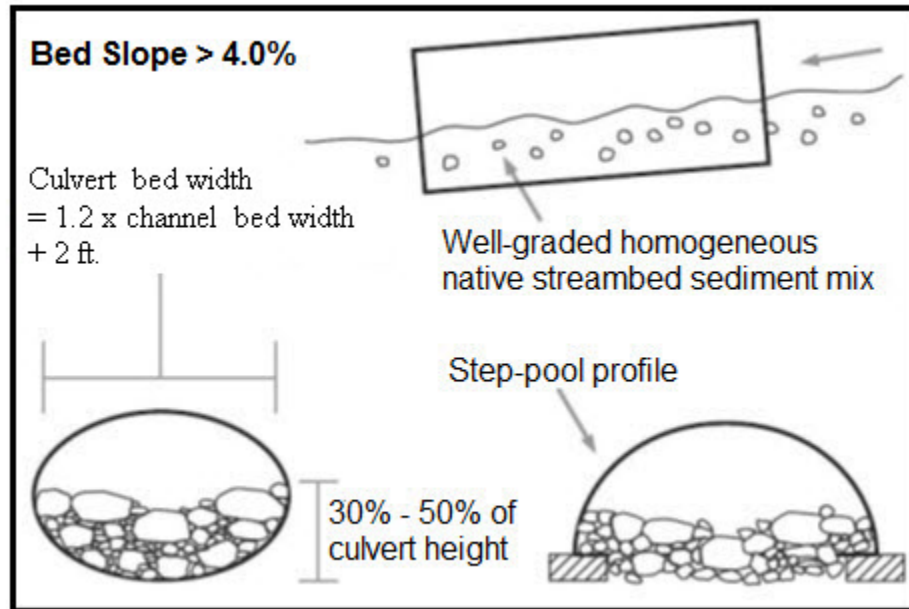


Figure 13 Profile and cross sections for typical stream-simulation culverts for low to moderate gradient settings (<4 percent slope) Source: Bates et al. 2003

Stream-simulation projects should be surveyed, designed and constructed in a manner consistent with the WDFW publication, *Design of Road Culverts for Fish Passage* (Bates et al. 2003), Chapter 6 - Stream Simulation Design Option. This publication can be found at <http://wdfw.wa.gov/publications/00049/wdfw00049.pdf>.



*Figure 14 Profile and cross sections for typical stream-simulation culverts for higher gradient settings (>4 percent slope) Source: Bates et al. 2003*

Stream simulation is achieved when physical conditions in the culvert look and function similarly to those in the adjacent natural channel. These conditions imply acceptable passage for fish and other aquatic organisms.

Typically, culverts are set along the natural stream gradient, countersunk 30 to 50 percent, filled with a range of streambed gravel sized to match the naturally occurring ambient substrate, resist scour, and are sized to a diameter  $D = 1.2$  times the channel bed width plus 2 feet.

#### 4.5.2.3 Hydraulic Design

This design option requires a high degree of expertise in hydraulic engineering and hydrologic and geomorphic modeling capabilities, a thorough understanding of the swimming performance and biological requirements of the target species, and site-specific survey information.

Historically, this method was a standard approach used to design culverts for fish passage. It has become less favored, however, because of uncertainty related to fish passage performance, a limited range of applicable settings, and a number of ecological limitations. Specifically, the passage requirements of many target species are poorly understood, which contributes to design uncertainty. Even when the passage requirements of target species are adequately addressed, the structure may fail to provide passage for non-target species. This may lead to a range of unforeseen ecological consequences. Considering the above, this design option is unlikely to achieve the objective of the forest practices rules to pass all fish species at all life stages.

Finally, this type of structure may not provide adequate transport of sediment and organic material, contributing to broader effects on ecosystem function, degradation of the adjacent stream channel, and declining performance over time.

Because of these limitations, the hydraulic design option is most commonly used for temporary retrofits of existing barrier culverts in circumstances where replacement or removal is not practical in the immediate future. See WDFW's *Design of Road Culverts for Fish Passage* manual (Bates et al. 2003) for additional guidance on this method.

#### *4.5.2.4 Alternative Design Methods*

Alternative design methods may be considered if they can be shown to meet or exceed fish protection standards. Alternative methods that haven't been demonstrated for their effectiveness in meeting fish protection standards are likely to require additional review. In addition, projects constructed under an alternative design method must be monitored for effectiveness. If the structure is shown to be ineffective over time, it will need to be replaced with a proven design method.

#### 4.5.3 Culvert Retrofitting

A culvert retrofit is a modification placed in an existing culvert in order to improve fish passage. Retrofits commonly include baffles and/or weirs inside the culvert barrel. However, baffles reduce the hydraulic capacity of culverts. These structures are complicated as they must alter water velocities to allow for fish passage in culverts that do not pass all fish. (See 4.5.2.3 Hydraulic Design above.) Retrofitting a culvert is not a long-term solution, but may be used in some instances until the culvert can be replaced with a fish passable structure such as a bridge or a stream-simulation culvert.

### **4.6 Bridges**

If properly located, sized, and installed, bridges provide the most protection to fish life and unimpeded fish passage, maintain natural channel processes, and provide the least risk of failure. Bridges are far less susceptible to plugging than culverts, and fish passage conditions under bridges are less likely to be affected by changes in streambed elevation. Pre-fabricated bridges are available that eliminate the complexity of engineering and may prove to be more cost effective than a culvert alternative. Bridge installation can be significantly simpler than culvert installation, with less in-water work, excavation, fill, and need for dewatering.

A bridge should be constructed in fish bearing waters where the site assessment indicates that a culvert is not a viable option. This is particularly true for larger streams and steeper channels, or when the movement of large debris or excessive sediment is frequent. See 4.2 Stream Channel Assessment.

The following guidelines apply both to new bridges and to the replacement of existing crossing structures. For the purpose of these guidelines, a bridge is any crossing that has separate structural elements for the superstructure, piers, abutments, and foundations.

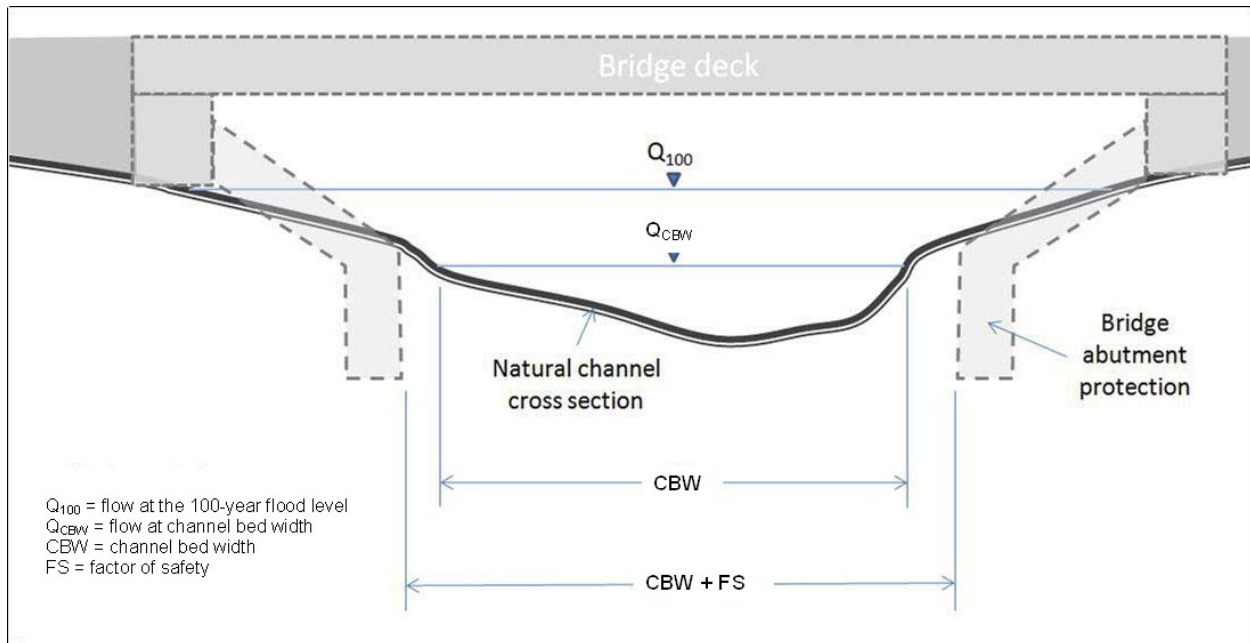
Appropriately designed bridges should protect natural geomorphic and fluvial processes. These goals can be achieved by:

- Preventing excessive backwater during floods that could lead to scour of the stream bed within the waterway.
- Preventing deposition of sediment upstream which could increase lateral shifting of the river channel and therefore require future bank armoring.
- Preventing or limiting local scour or coarsening of the stream substrate.
- Allowing free passage of woody debris expected to be encountered in the stream. This reduces maintenance and allows for distribution of wood downstream.
- Allowing natural evolution of the channel longitudinal profile (meander and vertical scour) to the extent compatible with safety of the bridge, its road approaches, and adjacent private property.
- Allowing continued down-valley flow of water onto the floodplain, thereby reducing flood height, providing flood capacity, and permitting side channel development and other riparian processes.
- Reducing the risk of bridge failure from catastrophic floods.

All items in the list above may not apply to every bridge crossing. In many cases, existing site constraints may have already reduced the natural level of the channel and fish habitat productivity as a result of past man-made features.

#### Bridge design and construction considerations

- Pier placement within the wetted area of channel bed width should be avoided.
- Existing channel spanning bridges that have exhibited no channel effects may be replaced with a similar bridge span.
- For confined channels, the distance between bridge abutments should be at least channel bed width and may need to be placed further apart to pass 100 year flood flows without causing backwater elevations to exceed 0.2 feet. Consultation with DNR and WDFW is advisable. Figure 15 illustrates the relationship between channel bed width and the bridge structure for confined channels. This figure shows a bridge founded on spread footings, and the abutment protection required to protect the bridge footings. Other foundation and abutment protection methods are possible and preferred, but the width required between them remains the same.



*Figure 15 Bridge cross section over a confined channel showing the relationship between the channel bed width and the recommended width between abutment protections. The factor of safety is determined by the designer. The bridge may also be founded on piling or drilled shafts which would eliminate scour risk.*

- Bridges should account for lateral channel movement (meandering) that will occur in their design life.
- In general, the bottom of the superstructure (stringers, girders, etc.) should be at least three feet above the 100-year flood level.
- The stream channel created or restored near and beneath the bridge should have a gradient, cross-section, and general configuration similar to the existing channel upstream and downstream of the crossing, provided that the adjacent channel has not been previously channelized.
- Bridge designs constructed in unconfined channels and floodplains can be more complex. Therefore, it is important that pre-application consultation occur with DNR and WDFW when anticipating bridge construction in such areas. Tribes may also be consulted for additional expertise.
- Floodplains adjacent to the channel also provide critical habitat for fish; therefore, impacts must be minimized. Spanning the entire width of the channel plus the floodplain is not usually practical, but preserving natural function of the floodplain is important. Therefore, careful consideration should be given for minimizing the possibility of floodplain areas being blocked or impeded by road approach embankments.

#### **4.7 Fords in Type S and F Waters**

Fords are a type of water crossing where vehicles drive through stream channels. They must be constructed and maintained in a manner that will prevent damage to fish life, habitat, and water quality. Fords have a high potential to generate and deliver sediment and may impede fish passage, both of which represent actual damage to public resources and must be avoided. However, under limited circumstances fords may be considered when they provide better public

resource protection than other water crossing structures. A well designed and maintained ford creates no channel constriction, passes debris, and poses no hazards associated with road fill.

Fords are only appropriate to use during periods of low or no stream flow (whether dry or frozen) and if sediment delivery is minimized or avoided. If flow conditions change, a ford crossing may no longer be an appropriate stream crossing method. Vehicular traffic should be isolated from flowing water whenever possible.

Fords should be used only in locations where the *protection of fish life*, habitat, and water quality can be assured. Whether a ford is appropriate or not depends on the characteristics of the stream to be crossed, local topography, and management of traffic on the road.

Fords should be the last resort and only used in cases where other crossing methods have been considered and rejected. Fords may be considered for temporary use in watercourses where:

- Stream banks are naturally low and channel depths shallow;
- There is gentle topography with low bank height and low gradient approaches;
- The stream has low flow or no flow during the anticipated season of use;
- The stream is associated with a spur road rather than a mainline, and where there is minimal traffic; and/or
- The stream is subject to mass wasting events, debris transport, or extreme seasonal peak flows.

In order to avoid resource impacts and minimize delays, it is strongly recommended that pre-application consultation occurs with DNR and WDFW when anticipating ford construction. Tribes may also be consulted for additional expertise. Timing restrictions or use conditions may be applied because fords have the potential to generate sediment delivery or harm fish. Therefore, anticipate that a written plan for ford construction and maintenance, and restoration of the stream crossing may be required upon application.

#### Construction BMPs

- Separate traffic from flowing water by utilizing a vented ford.
- Construct fords at right angles to the stream.
- Construct fords outside of all known or suspected spawning areas such as pool tailouts.
- Inspect and maintain fords to provide for fish passage and maintain water quality, and notify DNR if fish passage is impeded or water quality is impacted.
- If the streambed does not have a firm rock or gravel base, install clean, washed rock or gravel to reduce sedimentation. Concrete, pavement or other debris should not be used to construct hardened fords. Placement of material should be limited to the approaches and crossing.
- Restoration of a ford after it is used should include restoring the slope and revegetating/stabilizing the banks of the stream, as well as removing any non-native material that may alter stream flow.
- To complete restoration, block vehicular access to the crossing location.

#### Maintenance BMPs

Streambeds are part of a dynamic system where storm events frequently change the stream bed and banks. Fords should not require maintenance after every such event. Re-evaluate the use of a ford if frequent or extensive maintenance is required.



Maintain fords to:

- Keep road approach ditch-outs and water bars functioning.
- Minimize road surface runoff and control stream bank erosion. See Board Manual Section 3 Guidelines for Forest Roads, Part 4.3 Erosion Control.
- Prevent multiple approaches.
- Provide for unimpeded fish passage.

Construction and maintenance BMPs for fords in Type N Waters can be found in Part 5.3.

## **PART 5. WATER CROSSING STRUCTURES IN TYPE N WATERS**

### **5.1 Culvert Design**

Before designing a water crossing, you should verify the water type with DNR. Please refer to the water type definition in WAC 222-16-031. If unsure about how to determine *bankfull width*, see Board Manual Section 2 Standard Methods for Identifying Bankfull Channel Features and Channel Migration Zone. Contact DNR if you have questions.

This section includes three common methods to determine culvert sizing based on the *100-year flood level*, any one of which can be used. See Table 2. Alternative methods may be considered. To facilitate the application review process, you are encouraged to explain how you determined the appropriate culvert size if your proposed water crossing structure is less than bankfull width.

**Method A (Sizing Table Method)** uses field-verified bankfull width and average bankfull depth and Table 3 to determine the diameter of the culvert. You may need a larger size to accommodate debris if the culvert diameter is less than bankfull width.

**Method B (Bankfull Width Method)** uses field-verified bankfull width at the stream crossing to determine the diameter of the culvert.

**Method C (Hydraulic Design Method)** is a hydraulic-based crossing design method that uses estimated stream flows. The size of the culvert is based on the local 100-year flood level calculations and the nomograph in Figure 16. Use local knowledge of wood loading to appropriately size culverts for the passage of woody debris.

**Table 2. Three methods to size Type N Water culverts**

	<b>Method A Sizing Table</b>	<b>Method B Bankfull width</b>	<b>Method C Hydraulic Design</b>
<b>Summary</b>	Enter bankfull width and average bankfull depth into the culvert sizing table (Table 3).	Choose culvert diameter equal to or greater than bankfull width.	Calculate 100-year flow, determine culvert size using nomograph (Figure 16), and account for debris.
<b>Complexity</b>	Medium/Low	Low	High
<b>Data Required</b>	Measured bankfull width and average bankfull depth.	Measured bankfull width only.	100-yr flow (various methods and data requirements).
<b>Analysis Required</b>	Table 3	None	Peak flow calculation, use of nomograph (Figure 16).
<b>Does Method provide for passage of debris?</b>	No – needs additional consideration.	Yes	No– needs additional consideration.
<b>Where to use</b>	Where bankfull width and depth is easily determined.  Where basin area and/or hydrology are uncertain.	When simplicity is required.  Where bankfull width is clear, but depth uncertain.  Where abundant mobile debris is present at the site.	Where hydraulic expertise is available.  Where site-specific design and/or a non-round culvert are desired.  Where bankfull width and depth is difficult to determine.

**Table 3. Method A, culvert sizing table for Type N Waters**

Bankfull width (BFW) in Feet	Average Bankfull Depth in Inches											
	3	6	9	12	15	18	21	24	27	30	33	36
1	*15	*18	24	30	--	--	--	--	--	--	--	
2	24	30	30	36	42	42	48	48	--	--	--	B
3	30	36	42	48	48	48	54	54	54	60	60	60
4	30	42	48	54	54	54	60	60	66	66	72	72
5	36	48	54	54	60	60	66	66	72	72	78	78
6	36	48	54	60	66	66	72	72	78	78	84	84
7	42	54	60	66	72	72	78	78	84	84	90	90
8	42	60	66	72	78	78	84	84	84	90	90	90
9	48	60	66	78	78	84	84	90	90	90	96	96
10	54	66	72	78	84	84	90	90	96	96	96	--
11	60	66	72	84	84	90	90	96	96	--	--	--
12	66	72	78	84	90	90	96	96	--	--	--	--
13	66	78	78	90	90	96	--	--	--	--	--	--
14	72	78	84	90	96	96	--	--	--	--	--	--
15	78	84	90	96	96	--	--	--	--	--	--	--
16	78	84	90	96	--	--	--	--	--	--	--	--
17	84	90	96	--	--	--	--	--	--	--	--	--
18	84	90	96	--	--	--	--	--	--	--	--	--
19	90	96	--	--	--	--	--	--	--	--	--	--
20	96	96	--	--	--	--	--	--	--	--	--	--

\* See WAC 222-24-042(2) for details relating to size restrictions when installing culverts.

Method A (Sizing Table Method)

Step 1: Verify the stream is a Type N Water and then determine the bankfull width and average bankfull depth using methods shown in Board Manual Section 2 Standard Methods for Identifying Bankfull Channel Features and Channel Migration Zones.

Step 2: See the culvert sizing table (Table 3) to determine the diameter of the culvert. Consult with DNR for culvert diameters larger than 96 inches. For culvert sizes in the shaded areas of chart, it is recommended to use bridges, pipe arches, or open bottom culverts.

Method B (Bankfull Width Method)

Step 1: Verify the stream is a Type N Water. Measure the bankfull width in the field using the methods shown in Board Manual Section 2 Standard Methods for Identifying Bankfull Channel Features and Channel Migration Zones.

Step 2: Size the culvert diameter no smaller than bankfull width. *Note: This method may not be possible in areas that are difficult to accurately measure bankfull width.*

### Method C (Hydraulic Design Method)

Method C is a hydraulic-based crossing design method that uses an estimate of stream flow for a 100-year flood level to size culverts based on a nomograph. Figure 16 is a nomograph for calculating sizes for round corrugated metal culvert pipes on Type N Waters.

Limitations to the use of Method C:

- Hydraulic design method assumes there is culvert inlet control. This is a condition where the hydraulic capacity of the culvert is limited by the inlet configuration. This generally occurs in culverts steeper than 2 percent with unrestricted outflow.
- Flow measurements of past 100-year flood level may be unavailable.
- Estimated 100-year flow volumes may be hard to predict because of rain-on-snow events and inaccurate calculations of basin size.

Step 1: Verify the stream is Type N Water. Then determine the flow volume of the 100-year flood event ( $q$  value on the nomograph in Figure 16) by:

- Using stream flow records from gauged streams.
- Estimating the 100-year flood level. Table 4 lists three methods to estimate stream flows for the 100-year flood level.

Step 2: Use the nomograph in Figure 16 to determine the culvert diameter:

- Select culvert entrance type (armored headwall, mitered to slope, projecting).
- Select maximum headwater to culvert diameter ratio ( $HW/D$ ). Do not exceed 0.9 when using native soils for the fill. This will ensure performance without reliance on hydraulic pressure to pass storm events.
- Project a line from the Entrance Type bar through the Water Discharge bar ( $q$ ) to arrive at a point on the Culvert Diameter bar ( $D$ ).
- Round up to the nearest culvert diameter listed.
- Consider adding additional size to the culvert if debris is present in the stream.

**Table 4. Three ways to estimate the 100-year flood level to be used with Method C Hydraulic Design.**

	COMMENTS
<p><b>Regression Equations Method</b></p> <p>Follow instructions at <a href="http://wa.water.usgs.gov/pubs/wrir/flood_freq/">http://wa.water.usgs.gov/pubs/wrir/flood_freq/</a></p> <p>Further information may be found at <a href="http://water.usgs.gov/osw/streamstats">http://water.usgs.gov/osw/streamstats</a></p>	<p>Easy to use web-based method.</p> <p>Uses a prediction equation with a standard error of 37 to 77 percent.</p> <p>Best used for basins greater than 50 acres.</p> <p>Developed using lower elevation stream flow gauge stations that measured larger basin areas typical in forest culvert design.</p>
<p><b>Flow Transference Method</b></p> <p>Follow instructions at <a href="http://wa.water.usgs.gov/pubs/wrir/flood_freq/">http://wa.water.usgs.gov/pubs/wrir/flood_freq/</a></p>	<p>Useful method when water-crossing structure is in or near a gauged basin.</p> <p>Transfers in-stream gauge station information to an un-gauged drainage area.</p>
<p><b>Rational Method</b></p> <p>Follow instructions in chapter 2.5 of the Washington State Department of Transportation’s Hydraulics Manual at <a href="http://www.wsdot.wa.gov/Publications/Manuals/M23-03.htm">http://www.wsdot.wa.gov/Publications/Manuals/M23-03.htm</a></p>	<p>Uses rainfall intensity charts and equations to calculate flow for small basins less than 300 acres.</p> <p>Maps may be difficult to obtain for forested basins.</p>

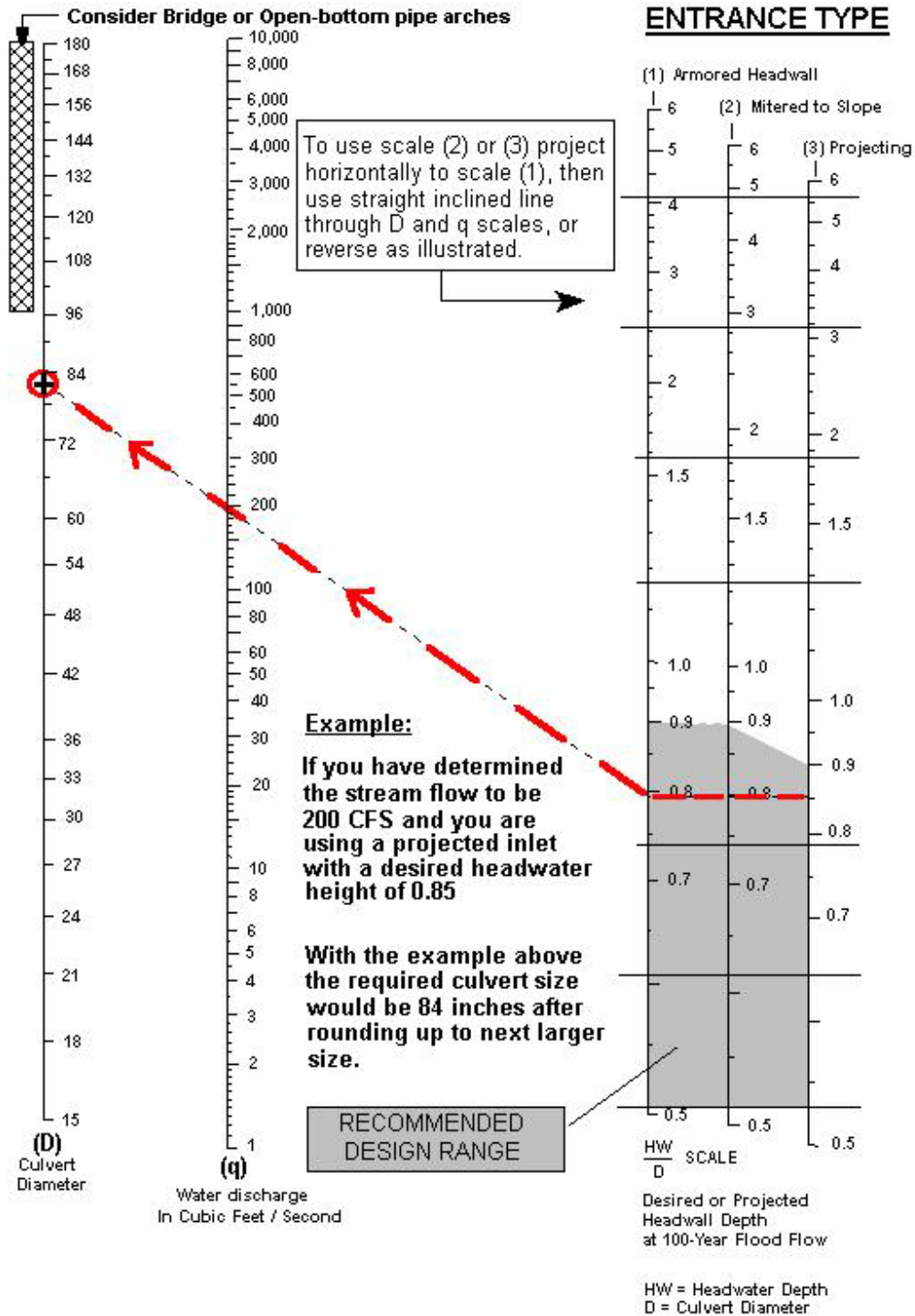


Figure 16 Nomograph for calculating sizes for round corrugated metal culvert pipe on Type N waters.

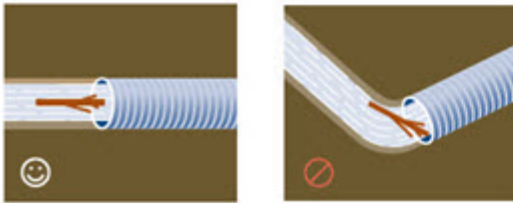
**5.2 Construction BMPs for Culverts and Bridges**

Minimizing the number of water crossings in the following locations will reduce road costs and risks to water quality and other public resources:

- In areas requiring steep road approaches.
- Across braided stream channels.

- On flat stream gradients immediately downstream of steep stream gradients. (These areas are susceptible to high sediment deposition.)
- In areas requiring deep fills.
- Immediately downstream of unstable slopes or landforms (see Board Manual Section 16 Guidelines for Evaluating Potentially Unstable Slopes and Landforms).

Figure 17 provides guidance for culvert design and installation that will reduce potential catastrophic failures due to debris (wood and sediment) blockages.



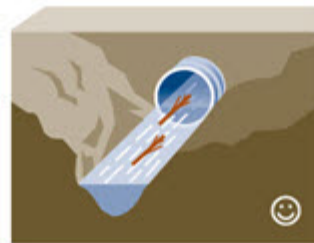
Align culvert with the stream channel.



In determining culvert size, be sure that the headwater depth at the 100-year flood level is no greater than 90% of the culvert diameter (HW/D ratio of 0.9 or less)



Match the culvert to the channel slope and elevation. This avoids pooling of the stream above the culvert.



Match the culvert width to the natural channel to reduce ponding. Do not widen the channel at the inlet. This will help keep woody debris oriented to pass the culvert.

Figure 17 Design to prevent culvert plugging hazard

### Deeper fills and streams with greater debris transport potential BMPs

Steeper gradient streams often require deeper fills over the crossing structure, increasing the amount of sediment that would be delivered if the fill fails. Steeper gradient streams also have the potential to transport more woody debris, increasing the risk of a plugged culvert. In these situations, where water is more likely to come over the road and cause fill failure, select the BMPs or other measures from the following list that best fit the local conditions:

- Construct an armored dip on the fill over the stream crossing structure. This reduces fill erosion potential and improves resistance to road failures resulting from high water flows and debris. Use coarse material, compact the fill, and armor with large rock.
- Dip the road grade and armor the fill to direct water onto stable vegetated ground within the natural drainage (see figures 19a and 19b).
- Outslope the road at the crossing.
- Construct an armored spillway at the intersection of the stream's gorge wall and the water-crossing fill.
- Place large riprap on the upstream fill slope and at the dip on the downstream fill slope.
- Install oversized culverts or *miter* the culvert inlet to improve flow characteristics and to help orient debris.
- Consider installing trash racks or debris deflectors above the inlet in channels with high debris transport.

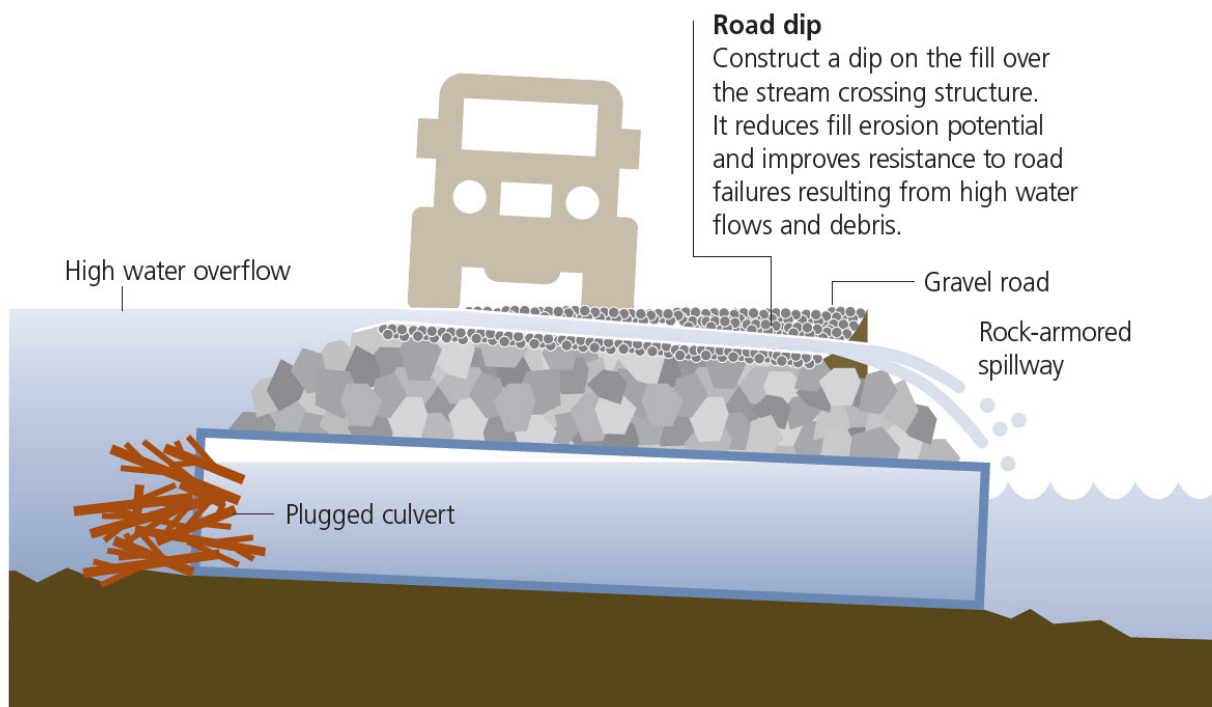
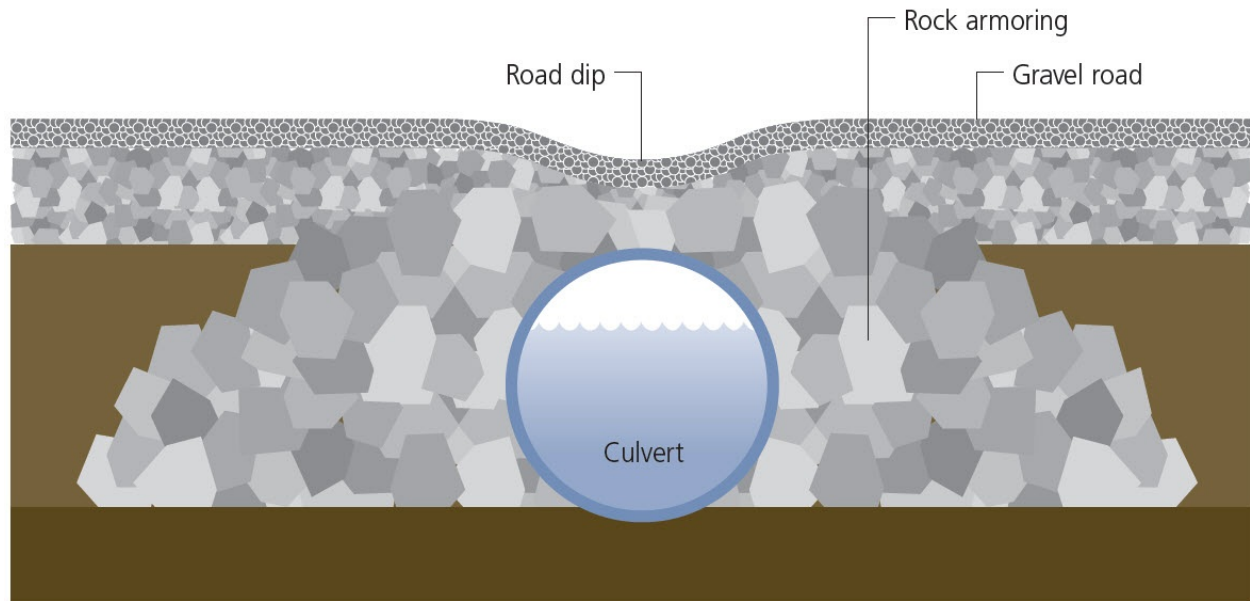


Figure 18a Armored relief dip design





*Figure 18b Armored Relief Dip Design.*

Consider increasing the size of a crossing structure when:

- The crossing is in the rain-on-snow zone.
- The crossing is in a location where ice jams or anchor ice can occur.
- The stream contains large amounts of mobile debris (wood, gravel).
- The crossing is inaccessible during winter.
- The crossing requires deep fills.
- Crossing a flat, broad area with poorly defined channels.
- You are considering installing a new culvert with a diameter equal to or less than bankfull width.

Water crossing construction BMPs

- Cover culverts with adequate fill according to manufacturer specifications. This minimizes damage to culverts during road maintenance. It also distributes the weight of passing vehicles, preventing culverts from being crushed.
- Prevent stream flow erosion by sizing culverts adequately. Placement of riprap around the inlet and/or outlet of a culvert may also prevent erosion.
- Use erosion control measures to armor fills to minimize erosion and sediment delivery. See Board Manual Section 3 Guidelines for Forest Roads, 4.3 Erosion Control.
- For roads with natural surfacing, apply surface rock at culvert approaches.
- In areas where beavers are present, consult DNR and WDFW.
- Place slash and/or debris above the 100-year flood level outside of the riparian management zone or wetland management zone in a stable location except where the material is used to construct sediment filters on road fill slopes.
- When within a quarter of a mile from a fish bearing stream, consult with DNR and WDFW to determine if there is a need for a bypass structure during installation to divert flowing waters and prevent delivery of sediment to the fish bearing water.
- Ensure that the culvert is set and bedded at an even grade without a hump, belly, or curves.

### Water crossing maintenance

Inspect all water crossing structures regularly and after storm events to ensure proper function. The following may indicate the need for maintenance or replacement:

- The stream flows regularly over the road.
- The stream flow is diverted from the culvert inlet and into the ditch.
- Severe erosion or scour within the ditch located downhill from the crossing.
- Stream flows diverted from the culvert inlet into another stream channel (basin).
- Streambed material accumulations at the culvert inlet.
- Down-cut channel bottoms and eroded stream banks occur immediately downstream of the culvert (outlet scour/drop).
- Erosion of the fill located above the culvert inlet.
- The culvert inlet is crushed or severely dented.
- The culvert inlet is damaged (inspect entire culvert to ensure it is fully functional).
- Sediment is delivering to typed waters.
- Evidence of head-cutting upstream of the water crossing structure.

### **5.3 Fords in Type N Waters**

Fords are a type of water crossing where vehicles drive directly through streams. They have a high potential to generate and deliver sediment, and are only appropriate to use during periods of no or low stream flow. If flow conditions change, a ford crossing may no longer be an appropriate stream crossing method. Vehicular traffic should be isolated from flowing water whenever possible.

Fords may be suitable in the following circumstances:

- Where there is minimal vehicle traffic.
- In sites where access limits regular maintenance.
- Where variable stream widths exist from frequent landslides, debris flows, or ice flows originating upstream.
- When culverts or bridges are not an option because:
  - The crossing is too difficult to maintain.
  - High debris loading is present in stream channel.

### Construction BMPs

- Fit the ford to the conditions on site (e.g., stream substrate and stream bank stability, stream width, depth and flow volume, lateral and vertical channel stability, flood frequency, debris loading).
- Install stabilizing material if the streambed does not have a firm rock or gravel base. Use reinforced concrete planks, crushed rock, riprap or rubber mats.
- Make sure equipment is in good working condition and doesn't leak oil.
- Install ditch-outs or water bars on each side of the approaches to divert water away from the stream.
- Construct the ford so you can maintain it.
- Construct temporary fords to facilitate abandonment and site rehabilitation.

### Maintenance BMPs

Streambeds are part of a dynamic system where storm events frequently change the streambed and stream banks. Fords should not require maintenance after every such event. If frequent or extensive maintenance is required, re-evaluate the use of the ford.

Maintain fords to:

- Keep road approach ditch-outs and water bars functioning.
- Minimize road surface runoff and control stream bank erosion. See Board Manual Section 3 Guidelines for Forest Roads, 4.3 Erosion Control.
- Prevent multiple approaches.

## **PART 6. WATER CROSSING STRUCTURE MAINTENANCE AND REPAIR**

Even when water crossing structures exceed *channel bed width*, they can require maintenance to provide for the transport of water, sediment, and wood, and in Type S and F streams, the free passage of fish. Large storm events can create high stream flows that transport large quantities of sediment and debris that can quickly overwhelm a culvert inlet. Culverts and most bridges are not designed to withstand debris flows, dam break floods, lahars, etc. Typically, properly designed and installed water crossing structures survive these catastrophic events and with proper maintenance their transport functions can be restored. However, chronic maintenance situations are usually a symptom of undersized or poorly performing water crossing structures and replacement should be considered when repeated maintenance responses are required to service the crossing structure. Although bridge piers and abutments can require some maintenance following peak flow events, culvert maintenance is the most common maintenance activity.

Maintenance activities should be accomplished whenever possible during low summer flows to:

- avoid times when fish are spawning;
- reduce impacts to the stream channel and flow; and
- to simplify and expedite the maintenance activity by taking advantage of low stream flows.

In seasonal streams, it is always best to conduct maintenance activities when dry or non-flowing.

Water crossing maintenance activities conducted outside the normal summer operating season should be considered an “emergency situation” requiring an expedited response to protect the structure or the road, or restore fish passage. This action should only occur when the road, the stream, or fish are immediately threatened.

### Maintenance and repair BMPs

Lengthening an existing bridge or culvert in a Type S or F Water is considered a new project rather than simple maintenance.

- Limit disturbance to the stream bank, stream bed, and riparian vegetation to that necessary to complete the maintenance or repair project.
- Where practical, accomplish work by hand or with hand-held tools in order to minimize disturbance to the stream.
- Stop work if fish are observed in distress, a fish kill occurs, or water quality problems develop.

- In Type S or F streams, the completed project must provide or maintain fish passage. This includes culvert repair activities.
- If the project is sufficiently large, bypass the stream flow to minimize disturbance to the stream and fish habitat. For additional guidance, see 4.3 Dewatering BMPs, and Part 9 Fish Capture and Exclusion.
- Operate equipment from the road, road shoulder, or bridge deck to reduce stream bank and riparian vegetation impacts.
- Clean equipment of soil, debris, and external petroleum products before working near the water. Also, inspect equipment daily for leaks and immediately repair it when detected. For additional guidance that may apply, see Equipment BMPs in Part 4.3.
- Restrict sediment removal from the culvert crossing to that necessary to restore flow through the structure and do not extend more than 25 linear feet upstream from the inlet or downstream from the outlet.
- Do not conduct sediment removal where fish are spawning or are known to spawn.
- Limit sediment removal to deepening the streambed; do not widen the streambed. Stream banks should not be modified or disturbed.
- Once the project is completed, the stream bed should not contain pits, *sumps* or depressions that can trap fish or create a fish passage barrier when water levels fluctuate.
- Relocate all excavated material to an approved waste site where it will not reenter typed waters unless directed otherwise by DNR.
- Relocate LWD whenever practical downstream from the culvert or bridge structure. See Part 10.3 Large Wood Placement, Removal or Repositioning for additional guidance.
- Remove and reposition debris in a manner that minimizes the release of bedload, logs or debris downstream.
- Repair culverts to restore their original, as-built condition, and provide unimpeded fish passage.
- Culvert repair may include headwall construction. Bridge repair may include replacement or installation of new bank armor. In all cases, limit rip rap installation to that necessary to protect the structure. See Part 10.4 Stream Bank Protection for additional guidance.
- When replacing bridge decking, do not deliver bridge parts to the stream. New decking material should not include creosote or pentachlorophenol.
- When painting a bridge, do not deliver paint chips or overspray new paint to the stream.
- Once the project is completed, protect the disturbed or exposed areas from erosion to ensure that fine sediment does not deliver to the stream.
- Depending on project scope and scale, re-vegetation or other activities may be necessary to restore the site to pre-project conditions. See Site Restoration BMPs in 4.3 for additional guidance.

## **PART 7. TEMPORARY CULVERTS**

In general, temporary culverts are used for a limited time and when streams are at low flows. In some instances, and depending on the location, temporary culverts may be used for more than one season within the effective period of an FPA to extract timber or provide temporary access. However, temporary culverts left in place September 30 to June 15 need to be designed to pass fish and accommodate the *100-year flood level* and anticipated debris. In these situations, and when designed properly, temporary culverts will have a minimal effect on stream processes and fish habitat.

Temporary culverts should be designed and installed to:

- Minimize the disturbance to the bed and bank of the stream;
- Safely pass the flows and debris expected during the time they will be in place; and
- Provide passage for fish migrating in the stream for the time the culvert will be in place.

#### Temporary culvert BMPs

- Placement and timing limitations for allowing temporary culverts in Type S and F Waters is determined based on the species of fish present at the proposed crossing location.
- Maintain unimpeded fish passage in all fish bearing streams. The best crossing locations have a low approach elevation and a narrow stream channel.
- Locate the crossing where the stream is relatively straight and minimal riparian vegetation is growing on the bank.
- Place the pipe on top of geotextile fabric and cover it with clean fill to minimize disturbance and easily restore the bed and banks of the stream. Log puncheon can be used alone or in association with a culvert to pass expected flow.
- Maintain the temporary culvert throughout the life of the project.
- Remove the culvert, associated fill, including log puncheon, and geotextile material in a manner that restores the site to pre-project conditions.
- Remove temporary culverts and all road approaches, and block traffic by a predetermined date.

### **PART 8. WATER CROSSING REMOVAL AND ABANDONMENT**

Road abandonment is the complete removal of bridges, culverts, fords, and associated fill, and the elimination or water barring of the connected roadways. For forest practices purposes, road abandonment is defined in WAC 222-24-052(3). Removal means a crossing is taken out with the intention of replacement at a later time. Both operations will re-establish fish passage, although the intended purpose of abandonment is to re-establish the natural drainage with no additional maintenance required.

Water crossing removal or abandonment should re-establish channel connectivity and the passage of fish if the stream is a Type S or F Water.

Generally, a water crossing removal should include:

- Creation of a channel that is similar in size and configuration to channel conditions upstream and downstream;
- A natural transition to the channel upstream and downstream of the crossing;



*Properly abandoned road crossing*

- Incorporation of large wood pieces, which can help expedite the restoration of the channel and fish habitat conditions. This wood is commonly available from trees removed from the road fill;
- Ensuring stable side slopes that do not exceed 2:1 unless matching the natural stream bank or valley walls; and
- Appropriate erosion control to address sediment delivery from exposed slopes.

Where water crossings are permanently abandoned, restoration of the channel and floodplain should include:

- Complete removal of the culvert or bridge support structures and all imported road fill material;
- Re-sloping of the banks to the original valley width, or at a minimum restoring the flood prone width of the stream to its natural capacity; and
- Re-vegetation and/or replanting of exposed stream banks or valley walls with native trees and shrubs to help expedite development of a functioning riparian condition.
- It is recommended that the road fill be excavated back to the flood prone width or the original valley width. This allows the stream to use its floodplain and re-establish the full riparian zone.
- In cases where the channel occupies a valley formed by glacial or fluvial processes far in excess of those present today (an *underfit channel*), it is recommended that the fill be pulled back to the flood prone width (the horizontal extent at a height of twice the bankfull depth).

Where water crossing removal is temporary and another structure is expected to be installed, the site may not require the same level of fill removal. In this case, water crossing removal should include removal of the culvert or bridge structure and associated fill. Typically, removal of fill should occur to at least *channel bed width + 2 feet*, or *channel bed width x 1.2*, whichever is greater. It is always preferable to pull fill back to at least the flood prone width (see Figure 19). In totally confined channels where channel bed width equals valley width, the fill removal need not exceed the channel bed width.

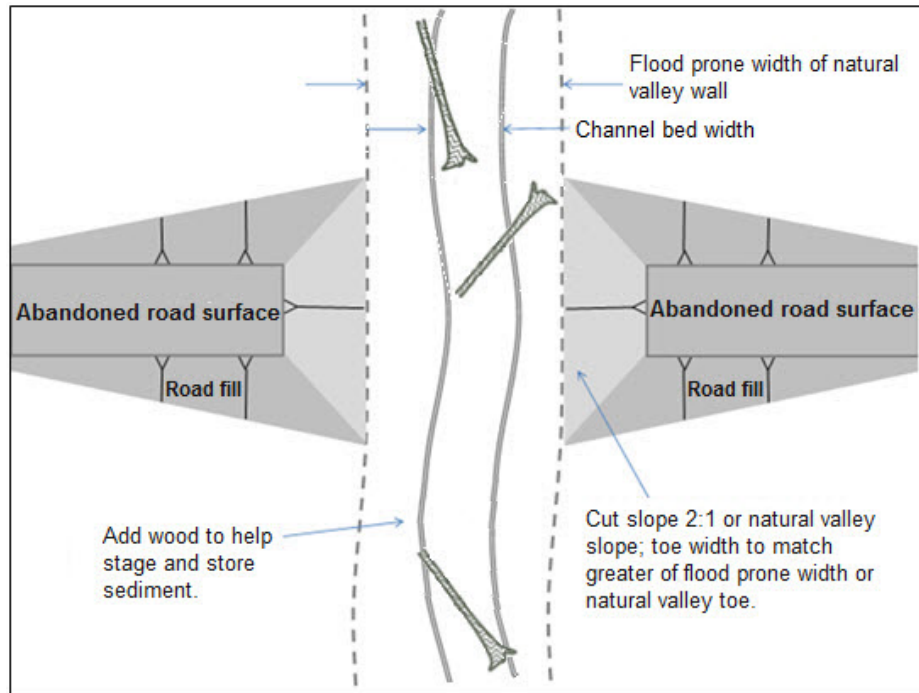


Figure 19 Plan view of road crossing abandonment showing excavation of road fill and placement of large wood when it is available on site and non-merchantable

When planning culvert removal, the overall drop through the culvert should be measured. The overall drop is the outfall height plus the vertical drop through the culvert (slope times length). See Figure 20. When the culvert is removed this overall drop will be expressed as a single vertical face at the inlet end of the excavation. This face will either regrade (downcut) or remain, depending on the height and the vertical face material.

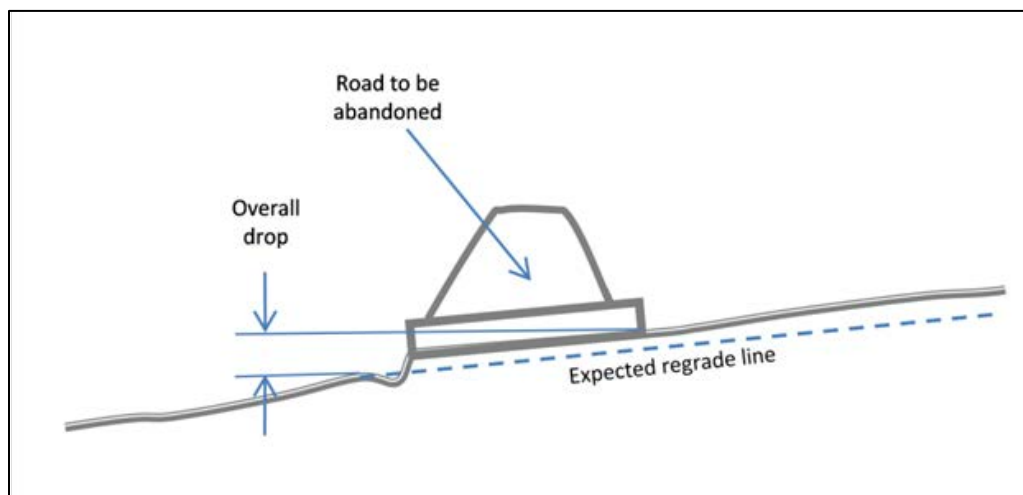


Figure 20 Profile view of road crossing abandonment showing the overall drop in water surface

When the outfall drop is moderate and the bed material mobile, the crossing can be abandoned and the regrade expected to resolve itself over time without repercussions. The concern is if the bed materials or the underlying soil or rock does not readily erode, there will be a distinct drop that can be a barrier to fish passage for a long time.

The following guidelines are recommended:

- If the overall culvert outlet drop is greater than one foot and the channel bed is composed of or underlain by soft or weathered bedrock, cemented glacial till, or hard clay, then the upstream bed should be excavated to form a continuous profile of a similar slope as the adjacent channel. A hard bedrock sill was probably present before the culvert was installed and will be the same challenge to fish passage as it was before. Adding wood and gravel from the fill slope to the excavation will improve channel recovery in this latter instance (shown in the upper profile in Figure 21).
- If the overall drop is less than 2 feet and the bed is gravel, then the culvert can be removed without further work done to the channel.
- If the drop is in excess of 3 feet, then the upstream channel should be regraded to form a continuous profile through the worksite and into the upstream channel (shown in the lower profile in Figure 21).

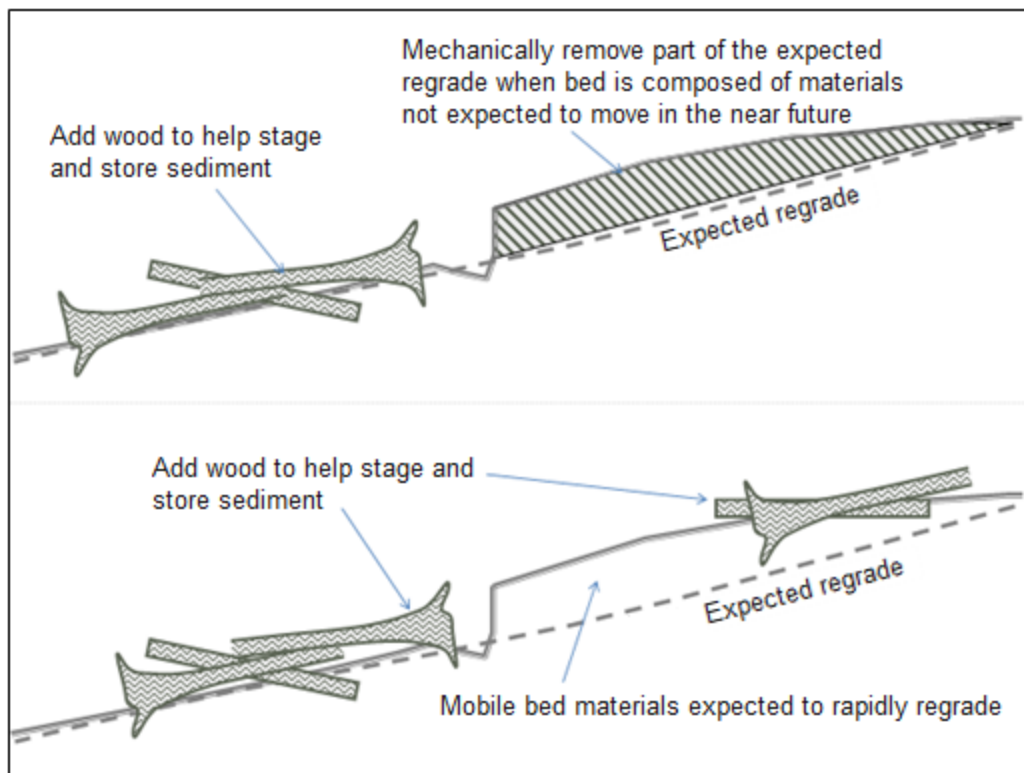


Figure 21 Stream profiles at road crossing abandonment sites showing two regrade treatments.



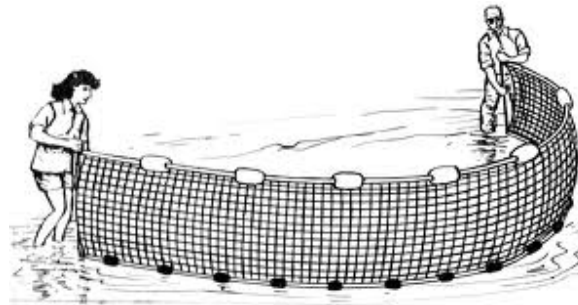
## PART 9. FISH CAPTURE AND EXCLUSION

If personnel and resources are available, WDFW and affected tribes may assist with capturing and moving fish from the job site to free-flowing water. DNR can help identify affected tribes in a given area.

- Generally, work below the *channel bed width* should be conducted in isolation from flowing waters.
- In most cases gradual dewatering or bypass should be done in conjunction with exclusion of fish from the work site.
- All individuals participating in fish capture and removal should have training, knowledge, and skills in the safe handling of fish.
- A plan should be designed to consider the channel characteristics and size of the area to be isolated, dewatering methods (diversion with a bypass flume or culvert, sandbags, sheet pile cofferdam, etc.), and the sequence of activities that will provide the best conditions for the safe capture and removal of fish.
- If the stream is small, where seasonal flows are substantially diminished and conditions of elevated temperature or reduced oxygen may be present, fish should not be herded upstream.
- In rare instances fish may have to be relocated a greater distance up or downstream to ensure fish are not concentrated in areas where their habitat needs cannot be met.
- Concentrate fish where they can be easily seined but not where they may be stressed for more than 30 minutes.
- If flows within the work area are gradually reduced over the course of a day or longer, fish may move downstream on their own, preventing the need for capture and relocation. However, if there is sufficient cover such as that provided by a culvert, fish will not likely move, making capture and relocation necessary.

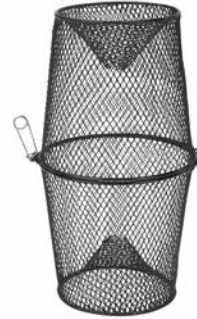
### Seining

- If listed fish are present, dip nets and seines must be composed of non-abrasive nylon material.
- Fish capture using a seine net is the preferred method of fish capture.
- For easier capture and to minimize stress, use seines with a bag built into the net.
- Seining during low light conditions such as at dawn and dusk is most effective.
- Snorkeling to help herd fish, in conjunction with the use of a seine net, will improve the success of fish capture.
- Small net mesh sizes usually work best unless water velocities are high.



Baited minnow traps

- Baited minnow traps may be used in conjunction with seining.
- To minimize predation, check traps at least four times per day.
- If water temperatures exceed 15 C, traps should be checked more frequently.

Dip nets

- When gradually dewatering a job site, dip nets are an effective way to capture fish.
- Aquarium nets may work best in very shallow locations for small fish.

Work area isolation using block nets

- If during the course of in-water work fish may re-enter the work area from downstream, a downstream block net should be installed.
- Select sites that exhibit reduced flow volume or velocity, uniformity of depth and good accessibility.
- Avoid sites with heavy vegetation, large cobble or boulders, undercut banks, deep pools, etc., due to the difficulty of securing and/or maintaining nets.
- Once the first block net is secured at the upstream end, a second block net should be used to herd fish downstream and out of the project area.
- Block nets will need to be composed of 9.5 millimeter stretched nylon mesh and installed at an angle to the direction of flow (not perpendicular to the flow) to avoid impinging fish in the net.
- To anchor block nets, bags filled with clean gravel should be placed along the bottom of the nets.
- Block nets must be secured along both banks and the channel bottom to prevent failure as a result of debris accumulation, high flows, and/or flanking.
- In order to keep fish out of the work site, block nets should be left in place until the work is complete and conditions are suitable for fish.
- Block nets require frequent inspection and debris removal and should be checked three times a day.

*Use of a block net*

Using electrofishing equipment to capture fish

- Electrofishing should not be used unless other methods of removing fish are unsuccessful. Attempts to seine or net fish should always precede the use of electrofishing equipment.
- Electrofishing methods and equipment must comply with National Marine Fisheries guidelines: *National Marine Fisheries Service. 2000. Guidelines for electrofishing water containing salmonids listed under the Endangered Species Act, [http://swr.nmfs.noaa.gov/sr/Electrofishing\\_Guidelines.pdf](http://swr.nmfs.noaa.gov/sr/Electrofishing_Guidelines.pdf).*



*Electrofishing to capture fish*

- A biologist with at least 100 hours of electrofishing experience should be on-site to conduct or direct all electrofishing activity.
- Visual observation techniques such as snorkeling or surveying with polarized glasses may be used to assess effectiveness of fish removal from the site.
- In order to minimize the risks to both personnel and fish, use the minimum voltage, pulse width, and rate setting necessary to create the desired response (galvanotaxis).
- Use only straight DC or pulsed DC current; never use AC current.
- Use low setting for larger fish because they are more susceptible to electrofishing injury than smaller fish.
- Electrofishing should not be used where spawning adults or redds may be exposed to electrical current.
- Electrofishing should not be conducted under conditions of poor water visibility.
- In order to provide a higher likelihood of detecting fish and to reduce injury to fish, a second person with a dip net should be positioned to catch stunned fish before they become impinged in block nets or are lost downstream.
- Immediately remove captured fish from nets and electrical field, and either relocate them downstream or hold in appropriate containers.
- Keep water in holding containers cool and well oxygenated.
- Do not hold ESA listed fish listed in containers for more than 10 minutes, unless containers are dark-colored, lidded and fitted with a portable aerator.
- If dark bands are observed on fish, or signs of stress or injury are noticed, immediately reduce electrofisher settings.

Fish handling, holding, and release

- Plan and conduct fish capture and removal to minimize the amount and duration of handling.
- Ensure that those handling fish have clean hands free of lotion, sunscreen, insect repellent, and other harmful substances.
- Ensure that capture buckets, coolers or holding tanks are maintained with clean, cold, well-oxygenated water.
- Captured fish should be held in containers that are large enough to avoid over-crowding of fish.

- Report any ESA listed fish accidentally killed as a result of fish capture and removal operations.

#### Reintroduction of flow and fish into isolated work area

- Reintroduce flows gradually into the isolated work area to prevent channel bed or bank instability, excessive scour, turbidity, or sedimentation.
- Make sure each fish is capable of remaining upright and actively swimming prior to release.
- Consider fish habitat characteristics such as flow, temperature, and cover when selecting locations to release fish.

## **PART 10. OTHER COMMON HYDRAULIC PROJECTS**

### **10.1 Beaver Dam Removal**

Beavers play an important ecological role in creating and maintaining ponds and wetlands for fish and wildlife habitat, as well as improving water quality through stormwater and sediment retention. Where beaver activity occurs in narrow bands of riparian habitat, it is often compatible with the management of forested uplands. However, beaver activity can negatively impact water crossing structures. Beaver impacts are often controlled through trapping to keep populations from reaching nuisance proportions. Beaver dam removal is an FPHP. For information or authorization related to beaver removal through trapping, go to <http://wdfw.wa.gov/licensing/trapping>.

When beavers build dams at bridges or culvert inlets, the pond created by the dam can result in a collapsed or compromised water crossing structure or a flooded stream-adjacent haul road. When the dam impounds a Type N Water, its removal can simply be accomplished in a manner that prevents a sudden release of scour-force flows and/or sediment or debris. When dam removal impacts a Type F or S Water, additional impacts must be considered. Beaver dams that do not pose an imminent threat to roads are to be left undisturbed.

Beaver dams should be removed or modified only when:

- The continued existence of the beaver dam poses an imminent danger as defined in to [RCW 77.55.011\(12\)](#) to the integrity of bridge piers, culverts, or roads; and
- The beaver dam has been in existence for one year or less. Older dams will be considered on a site-specific basis.

#### Beaver dam removal BMPs

- Avoid dam removal when fish are spawning or when spawning habitat is within 300 feet of the dam. Consult with WDFW for the appropriate work window.
- Leave large wood (>12 inches diameter and  $\geq 6$  feet length) in place or move it downstream of the crossing.
- Leave LWD imbedded in the stream bed or banks undisturbed.
- Remove and dispose of smaller limbs and bark debris where they will not re-enter the stream or be available for further beaver activity.
- Streambed or bank excavation, or channel realignment, are not authorized.
- Do not use explosives.
- Remove the dam by hand or with hand tools. Chain saws or vehicle winches may be used to dislodge some of the debris, provided siltation to the downstream areas can be held to a minimum and impacts to *fish life* avoided.

- Station large equipment needed to remove the dam on the bank. However, if equipment is used, it should be operated from the roadway, the road shoulder, or the crossing structure to minimize disturbance to the stream banks and riparian vegetation.
- Remove the dam and debris in a manner that results in a controlled, slow release of impounded water. Down-ramping of the water should not result in stranding fish, or cause damage or erosion to the stream bed or banks.
- Ensure that equipment is free of external petroleum-based products while working near the water.
- Take extreme care to ensure that no petroleum products, hydraulic fluid, sediment-laden water, chemicals, or any other toxic or harmful materials are allowed to enter or leach into the stream.
- Inspect dewatered areas to ensure fish are not stranded. If fish are stranded, capture and move them to the nearest free-flowing water.
- Minimize damage to stream-adjacent vegetation. Re-vegetate disturbed areas and protect against erosion.
- An alternative to removing a beaver dam may be to install a structure like a beaver deceiver which will allow stream flow through the landowner's structure without eradicating the animal. For more information on preventing beavers from plugging culverts, see <http://www.wdfw.wa.gov/living/beavers.html>.

#### Mitigating for unavoidable impacts for beaver dam removal or modification

- Possible impacts should be considered on site and may include:
  - Loss of pool habitat.
  - Removal of habitat forming wood from the channel.
  - Possible scour of downstream channel if difficulty implementing BMPs is encountered, resulting in uncontrolled, rapid releases of impounded water.
- Potential mitigation measures:
  - Repositioning or installation of large wood downstream of the beaver-influenced infrastructure.
    - Installed or repositioned wood should be a minimum of 12 inches in diameter and 6 feet in length.
    - Wood should be placed so as to interact with stream flow.
    - Wood should be placed so as not to create fish passage barriers.
    - The total number of installed pieces should be determined on a case by case basis, and should be proportionate to the size of the stream.
  - Planting of appropriate species within the riparian zone formerly inundated by beaver activity.

#### **10.2 Logging Cable Suspension Activities**

In the simplest case, this activity category refers to the suspension of logging cables across fish bearing waters to establish tailholds in locations that facilitate “lift” or deflection for tower logging activities. Increased lift results in less soil disturbance during upland logging activities, as well as improved logging safety. A more complex case includes the suspension of payloads (cable yarding) across fish bearing waters. This facilitates landowner access to properties on both sides of a stream where terrain, ownership boundaries, or timber type lines preclude environmentally sensitive road access alternatives.

General BMPs applicable to all cable crossings across streams

- Fully suspend logs transported across Type S or F Waters so no portion enters the stream or damages the bed and banks.
- When changing tailholds over Type S or F Waters, move the lines over or around leave trees and riparian vegetation prior to re-tightening. Suspend cables at a height that minimizes damage to riparian vegetation during yarding activities.
- Do not fell trees into or across Type S or F Waters. However, if this does occur, leave the tree where it entered the water. Do not disturb large woody material in place prior to logging.
- With each cable road change, remove and dispose of limbs and other small debris that enter the stream during logging activities where they will not re-enter the stream.
- Stop cable logging activities if sedimentation occurs in Type S or F streams until the proper erosion control measures are put in place.

BMP applicable to cable suspension only (i.e., not involving timber yarding)

- Work across Type S or F Waters is allowed year-round and limited to the placement, suspension, repositioning, and removal of cables over the stream.

BMPs applicable to yarding timber over streams

- Year-round yarding across Type S or F Waters is allowed when the logs are fully suspended over the trees within the RMZ and the stream.
- Use yarding corridors if full suspension over the trees within the RMZ is not achievable.
- Yarding across Type S or F Waters is generally appropriate from June 1 through September 30 when fish are not spawning. However, consult WDFW for specific spawning timing.
- To maintain the integrity of the riparian zone, yarding corridors must be no wider or more numerous than necessary to accommodate safe and efficient transport of logs. Use natural openings where practical.
- Use the equipment and methods that minimize the number of corridors and RMZ impacts such as skyline yarders with drop-line carriages or other lateral yarding capabilities. For DNR to assess RMZ impacts, provide yarding profiles and the number and locations of proposed corridors in the FPA.
- Use directional felling techniques to fall corridor trees away from the stream channel unless directed by DNR. Leave riparian trees on site.

Mitigating for unavoidable impacts associated with cable suspension through Type F riparian buffers with removal of riparian trees

- Possible impacts should be considered on site and may include:
  - Loss of riparian function.
- Potential mitigation measure:
  - Felling of timber into riparian buffer or across stream (if appropriate) for possible recruitment by stream.

**10.3 Large Wood Placement, Removal, and Repositioning**

Large wood is an essential component of the stream system both in terms of biological diversity and structural complexity. It maintains channel stability and provides shelter for fish from high flows and predators. Large wood traps sediment that can create spawning habitat and provides a medium for aquatic insect production. In forests, wood is typically placed or repositioned as part of an FPHP, either for mitigation purposes or simply to complete the project. It is often necessary

to remove or reposition large wood from the channel that is threatening an existing structure such as a bridge pier or a culvert. In these cases it is always best to retain the wood in the stream system if possible. This can be accomplished by relocating the wood downstream from the structure, but not if it could jeopardize downstream structures.

#### Large wood placement, repositioning or removal BMPs

- Only remove large wood from a stream where necessary to address safety or infrastructure concerns.
- Relocate large wood removed for maintenance or to reduce infrastructure risk downstream whenever possible so as not to reduce the large wood loading in the stream.
- Incorporate relocated large wood into the channel to provide stable, functional fish habitat. This may include placing channel-spanning logs, creating log jams, or introducing a single large log or rootwad to the channel.
- Lift and elevate above the stream when removing and placing large wood to minimize disturbance to the stream bed or banks.
- Leave large wood embedded in the bank or bed undisturbed and intact unless authorized for removal or repositioning.
- Activities should not occur where fish are spawning, or where spawning beds (redds) are visible or documented. Consult with WDFW for spawning and incubation location and timing.
- Remove unattached limbs, bark, and other small woody debris from the stream and place in a location where it will not reenter the stream.
- Large wood repositioning should not result in the release of stream substrate, logs, or debris downstream from the project that could impact the channel, impair fish habitat, or threaten other infrastructure.
- Large wood repositioning should be conducted to avoid or minimize damage or disturbance to the bed, banks, or riparian vegetation.
- Level depressions in gravel bars resulting from the wood repositioning that could strand fish.
- Operate equipment used for repositioning from the road, bridge surface, or road shoulder whenever feasible to reduce disturbance to the stream bank or sensitive riparian vegetation.
- For mitigation purposes or large wood enhancement projects, use the largest wood available, preferably cedar or Douglas fir, with attached roots and a length that will exceed the channel width. If the large wood is without attached roots, the wood length will need to exceed the channel width in order to remain stable in the stream.

#### 10.4 Stream Bank Protection

A bank protection structure is constructed to protect a stream bank from anticipated erosion or to stabilize an eroding stream bank. For forest practices purposes, this activity is typically associated with forest road or water crossing structure protection.

Water crossing bank protection is commonly applied under bridges to stabilize banks and protect abutments and soils around culvert inlets as headwalls to guard against scour and/or stabilize road fill material. Stream bank protection is typically restricted to the water crossing structure site and is relatively simple.

Protection of forest roads is more complicated and involves careful planning and design. It requires a clear understanding of why the erosion is occurring based on some knowledge of

stream channel dynamics (for example, the channel migration, channel configuration, and stream energy). This understanding will influence the bank protection design or the decision to simply move the road away from the stream.

It is highly recommended that landowners review WDFW's guidelines regarding channel processes, site assessment, and bank protection solutions in the *Integrated Streambank Protection Guidelines* (Cramer et al. 2003) at <http://wdfw.wa.gov/publications/00046/wdfw00046.pdf> . Landowners are also encouraged to consult with DNR and WDFW prior to submitting an FPA for bank protection projects that involve stream-adjacent road protection.

#### Guiding principles for stream bank protection along stream adjacent parallel roads

- Natural erosion processes and rates are essential for ecological health of the aquatic system.
- Human-caused erosion that exceeds natural rates is usually detrimental to ecological functions.
- Natural processes of erosion are expected to occur throughout the channel migration zone (CMZ). Project considerations should include the CMZ and potential upstream and downstream effects.
- Preservation of natural channel processes will sustain opportunities for continued habitat formation and maintenance.

Stream bank stabilization will alter the bed and banks and the physical processes that form and maintain fish habitat. Direct impacts to habitat may include loss of hiding cover, spawning beds, large woody material, riparian function, and channel alteration that decreases complexity and diversity of fish habitat. Therefore, it is usually best to relocate the road or other structure away from the eroding bank to allow natural channel functions to continue. If relocation is not possible and bank protection is necessary, then it should be designed and installed in the least impacting way.

Bank protection methods are either hard approaches utilizing rip rap, concrete, or timber, or soft approaches that incorporate biotechnical methods and materials such as live plantings, root wads, and LWD to mimic natural stream processes. Biotechnical approaches are preferable to hard approaches and should be considered first. Additional mitigation may be necessary if a hard approach is selected. Such mitigation may include the addition or incorporation of root wads, LWD, or other biotechnical elements such as plantings and soil lifts into the bank protection structure.

#### Stream bank protection BMPs

- Conduct a site and stream assessment to help understand the failure mechanism(s): toe erosion, scour, mass failure, avulsion, etc.
- Determine the level of risk to both the stream and the stream-adjacent road associated with the options:
  - No action; move the road
  - Soft armor
  - Hard armor
- Attempt to utilize soft protection methods. Consider riparian plantings in combination with LWD placement or log jam installation, soil lifts, etc.



- Restrict the bank protection project to the work necessary to protect the eroding banks.
- Restrict the bank protection footprint within the channel to the minimum necessary to protect the toe of the bank, or for the installation of mitigation features approved by DNR.
- Do not disturb or remove LWD that is embedded in the channel or banks except where unavoidable and/or where DNR authorizes removal.
- Design and install the toe of the structure to protect the integrity of the bank protection materials. In other words, use sufficiently sized rock or logs keyed for stability, and bury them below the scour elevation to serve as a foundation to hold the entire structure in place.
- Slope and configure the bank to a stable configuration; rock slopes should not exceed 1.5:1; soft armor should not exceed 2:1 (expressed in run over rise).
- If rip rap is utilized for bank protection material:
  - Conduct the project so spoils and overburden material are retained on the bank face and do not enter the stream channel. Use angular rock to maximize integrity and install to withstand 100-year flows.
  - Do not use rounded material or river rock as it does not provide a stable configuration.
  - Operate equipment from the top of the bank whenever possible to minimize impacts to the stream or channel.
  - Do not end dump rip rap but rather individually place the rock to interlock the material into a stable structure.
  - Protect from erosion all exposed or disturbed areas with the potential to deliver sediment using wheat straw blankets, fabric, wood chips, etc.

#### Mitigating for unavoidable impacts associated with stream bank protection

- Possible impacts should be considered on site and may include:
  - Disconnecting the stream from its floodplain and/or CMZ (when present) resulting in accelerated velocities during flood flows.
  - Hardening of banks or simplification of bank texture, resulting in reduced energy dissipation, accelerated velocities, and potential scour of the channel and adjacent banks.
  - Channel simplification resulting in loss of spawning and/or pool habitat.
  - Removing habitat forming wood in the channel or banks to install bank protection.
- Potential mitigation measures:
  - Repositioning or installing large wood downstream of or adjacent to treated sections of bank.
    - The total number and size of installed pieces should be determined on a case by case basis and should be proportionate to the size of the stream. For guidance on appropriate placement piece diameters, please see Board Manual Section 26 Guidelines for Large Woody Debris Placement Strategies.
    - Wood should be placed so as to interact with stream flow.
    - Wood should be placed so as not to create fish passage barriers.
  - Planting appropriate vegetation species on disturbed areas within the project limits.

#### **10.5 Other Hydraulic Projects**

Hydraulic projects covered in this Board manual commonly occur on forest land in association with other forest practices activities and are regulated by DNR. Occasionally, hydraulic projects may occur on forest land that fall under WDFW's jurisdiction and are regulated under the Hydraulic Code rules (chapter 220-110 WAC). Forest landowners should contact WDFW and

DNR for guidance on best management practices and permitting processes for these hydraulic projects, including but not limited to:

- channel change and realignment
- dredging in fresh water areas
- outfall structures
- tide gates
- bulk heads
- salt water bank protection
- conduit crossings

## GLOSSARY

“**Aggradation**” means the geologic process by which a streambed is raised in elevation by the deposition of additional material transported from upstream.

“**Bankfull width**” means:

- (a) For streams - The measurement of the lateral extent of the water surface elevation perpendicular to the channel at bankfull depth. In cases where multiple channels exist, bankfull width is the sum of the individual channel widths along the cross-section (see board manual section 2).
- (b) For lakes, ponds, and impoundments - Line of mean high water.
- (c) For tidal water - Line of mean high tide.
- (d) For periodically inundated areas of associated wetlands - Line of periodic inundation, which will be found by examining the edge of inundation to ascertain where the presence and action of waters are so common and usual, and so long continued in all ordinary years, as to mark upon the soil a character distinct from that of the abutting upland.

“**Channel bed width**”, for the purposes of the guidelines in this board manual, is defined in the text box in Part 4.2.

“**Fish life**” means all fish species including but not limited to food fish, shellfish, game fish, and other non-classified fish species and all stages of development of those species.

“**Forest practices hydraulic project**” (FPHP) means a forest practices activity that includes the construction or performance of work that will use, divert, obstruct, or change the natural flow or bed of any Type S, F, or N Water. Stand-alone proposals involving channel change and realignment, dredging in fresh water areas, and constructing outfall structures are not forest practices hydraulic projects and remain governed by chapter 77.55 RCW and chapter 220-110 WAC.

“**Invert**” means the bottom of the culvert.

“**Mitered culvert**” means a culvert that has the inlet or outlet cut to fit the angle of the fill slope.

“**Nick point**” means an abrupt change in gradient in the stream profile such as a waterfall, typically due to a change in rate of erosion.

“**No-net-loss**” means:

- (a) Avoidance or mitigation of adverse impacts to fish life; or
- (b) Avoidance or mitigation of net loss of habitat functions necessary to sustain fish life; or
- (c) Avoidance or mitigation of loss of area by habitat type.

“**Protection of fish life**” means the prevention of loss or injury to fish or shellfish, and the protection of the habitat that supports fish and shellfish populations.

“**Sump**” means a low or recessed area created for collecting water or sediment. Sumps are created to capture water when pumping or acting as filtration.

**“Unconfined stream”** means a stream with a 100-year floodplain width greater than two times the channel width. Typically, channel confinement is a description of how much a channel can move within its valley before it is stopped by a hill slope or terrace (Rosgen 1996). Unconfined channels can display visible changes in channel characteristics when flow, sediment supply, or the supplies of roughness elements such as LWD are altered. These areas are commonly referred to as response reaches, and usually possess an active floodplain.

**“Underfit channel”** means a stream that appears to be too small to have eroded the valley in which it flows; a stream whose volume is greatly reduced or whose meanders show a pronounced shrinkage in radius. It is a common result of drainage changes affected by capture, glaciers, or climatic variations.

**“Vented ford”** means a crossing structure where relatively frequent overtopping is expected, but where the driving surface is elevated some distance above the streambed. Culverts (vents) allow low flows to pass beneath the roadbed.

**“100-year flood level”** has the same meaning as “flood level – 100 year” in WAC 222-16-010: **“Flood level - 100 year”** means a calculated flood event flow based on an engineering computation of flood magnitude that has a 1 percent chance of occurring in any given year. For purposes of field interpretation, landowners may use the following methods:

- (a) Flow information from gauging stations;
- (b) Field estimate of water level based on guidance for "Determining the 100-Year Flood Level" in the forest practices board manual section 2.

The 100-year flood level shall not include those lands that can reasonably be expected to be protected from flood waters by flood control devices maintained by or under license from the federal government, the state, or a political subdivision of the state

## RESOURCES

American Iron and Steel Institute. 1994. *Handbook of Steel Drainage & Highway Construction Products*.

Bates, K. M. et al. 2003. *Design of Road Culverts for Fish Passage*. Washington Dept. of Fish and Wildlife. <http://wdfw.wa.gov/publications/00049/wdfw00049.pdf>

Cramer, Michelle et al. 2003. *Integrated Streambank Protection Guidelines*. Washington Department of Fish and Wildlife. <http://wdfw.wa.gov/publications/00046/wdfw00046.pdf>

National Marine Fisheries Service. 2000. *Guidelines for electrofishing water containing salmonids listed under the Endangered Species Act*.  
[http://swr.nmfs.noaa.gov/sr/Electrofishing\\_Guidelines.pdf](http://swr.nmfs.noaa.gov/sr/Electrofishing_Guidelines.pdf)

Rosgen, D., Ed. (1996). *Applied River Morphology*. Pagosa Springs, CO, Wildland Hydrology.

Sali-Caromile, Kay et al. 2012. *Stream Habitat Restoration Guidelines*. Washington Department of Fish and Wildlife. <http://wdfw.wa.gov/publications/01374/>

Washington Department of Ecology. 2012. *Stormwater Management Manual for Western Washington*. <http://www.ecy.wa.gov/programs/wq/stormwater/manual.html>

Washington Department of Ecology. 2004. *Stormwater Management Manual for Eastern Washington*. <http://www.ecy.wa.gov/programs/wq/stormwater/easternmanual/manual.html>  
(Eastern Washington)

West Virginia Department of Environmental Protection. 2013. *Pebble Count*.  
<http://www.dep.wv.gov/WWE/getinvolved/sos/Pages/SOPpebble.aspx>

Western Wood Preservative Institute. 2012. <http://www.wwpinstitute.org/aquatics.html>

Wolman, M. G. 1954. A method for sampling coarse riverbed material. *Transactions of the American Geophysical Union*. 35(6): 951-956.

## Section 6

### Guidelines for Determining Acceptable Stocking Levels

<b>PART 1. PROCEDURES</b> .....	<b>1</b>
<b>PART 2. REFORESTATION PLANS</b> .....	<b>3</b>
Table 6.1 Stocking and spacing guide .....	4

These guidelines may be used with **Chapter 222-34 WAC** to determine acceptable stocking levels of harvested areas. See **WAC 222-34-010** for Western Washington or **WAC 222-34-020** for Eastern Washington.

#### **PART 1. PROCEDURES**

1. Sample entire harvested area at two plots per acre. For seedlings use a plot radius of 9.6' in Western Washington and 10.8' in Eastern Washington. For larger trees, use plot radius of 10.2' in Western and Eastern Washington. Establish plot centers one chain (66') apart along lines spaced five chains (330') apart. Begin plot line 2.5 chains (165') from harvest unit boundary. Sample the range of elevations and conditions on the site. Shift plot lines if necessary to get representative sampling.
2. Shift or delete plots on areas unsuitable for commercial timber production such as: roads, stumps, logs, rocks, slides, water bodies and other areas that will not support reasonable tree growth.
3. Count up to two established seedlings, or count one advanced reproduction, sapling or merchantable tree per plot. Record and total separately for *one seedling/plot* or *one tree/plot*, for *two seedlings/plot* and for *plots not stocked*. Do not count seedlings or trees less than half the height of the dominant seedling or tree in the plot. Also note whether conifer or hardwood, or indicate actual species.
4. Seedlings, advanced reproductions, saplings and merchantable trees must be vigorous, without damage to roots and stem that would cause mortality or reduce merchantability, free from competing vegetation, and must have survived at least one growing season on the site.
5. Acceptable stocking with seedlings means at least 55% of all the plots have two or more established seedlings/plot while 20% of all the stocked plots have at least one established seedlings/plot.
6. Acceptable stocking with advanced reproductions, saplings, or merchantable trees means 75% or more of all the plots are stocked with one or more trees/plot.
7. Calculation of seedlings/plot data.

Seedlings Plots	Plot Radius in Feet	Seedlings/Acre at 100% Stocking
Western Washington (190 seedlings/acre)	9.6	
Plots w/at least 2 or more seedlings		300
Plots w/only 1 seedling		150
Eastern Washington (150 seedlings/acre)	10.8	
Plots with at least 2 or more seedlings		240
Plots with only 1 seedling		120

Calculate the average number of well-distributed seedlings or trees per acre using procedures 1, 2, 3, and 4 and the arithmetic steps described in A or B.

- A **Western Washington** - 190 well-distributed seedlings per acre are required. Multiply 150 by the number of plots with only 1 seedling. Next, multiply 300 by the number of plots with 2 or more seedlings. Add the answers and divide by the **total** number of plots taken. If the answer is less than 190, the area may be under stocked.
- B **Eastern Washington** - 150 well-distributed seedlings per acre are required. Multiply 120 by the number of plots with only 1 seedling. Next, multiply 240 by the number of plots with 2 or more seedlings. Add the answers and divide by the **total** number of plots taken. If the answer is less than 150, the area may be under stocked.

The average number of established, well-distributed seedlings/acre is calculated by using the following formula:

<b>Western Washington</b>		
Multiply 150 x _____ # of plots with only 1 seedling		= _____ Total 1
Multiply 300 x _____ # of plots with 2 or more seedlings		= _____ Total 2
Add Total 1 and Total 2		= _____ TOTAL 3
Divide TOTAL 3 by the total number of plots taken (Including the total number of plots with NO seedlings.)		
This answer is the average number of well-distributed seedlings/acre.		= _____

<b>Eastern Washington</b>		
Multiply 120 x _____ # of plots with only 1 seedling	=	_____ Total 1
Multiply 240 x _____ # of plots with 2 or more seedlings	=	_____ Total 2
Add Total 1 and Total 2	=	_____ TOTAL 3
Divide TOTAL 3 by the total number of plots taken (Including the total number of plots with NO seedlings.)		
This answer is the average number of well-distributed seedlings/acre.		
	=	_____

8. Calculations of plot data for larger trees.

Statewide (100 Trees/Acre)	Plot Radius in Feet	Trees/Area At 100% Stocking
Plots with 1 or more advanced reproduction, sapling, and merchantable tree	10.2	133

Calculate the average number of established, well-distributed trees/acre using this formula:  
**Both Western and Eastern Washington:** 100 well distributed merchantable trees, saplings or advanced reproductions per acre are required. Multiply 133 by the number of plots with 1 or more trees. Divide the answer by the **total** number of plots taken. If the answer is less than 100, the area may be under stocked.

<b>Plot Data for Larger Trees</b>		
Multiply 133 x _____ # of plots with 1 or more trees	=	_____ Total 1
Divide Total 1 by the total number of plots taken (The answer is the average number of well-distributed trees/acre.)		
	=	_____

The department may approve lower stocking levels that reasonably utilize the timber growing capacity of the site.

**Note:** Plot size and sampling procedures allow for some variation in distribution and stocking. Further adjustments are not needed.

**PART 2. REFORESTATION PLANS**

1. Adequate site preparation, vegetation control, and proper handling and planting of seedlings is required. When planting or seeding, a reasonable allowance must be made for expected mortality.



2. With favorable conditions, good planting stock, and skilled people, 80% - 90% seedling survival, after two full growing seasons, is possible. More typically, 70% - 80% survival may be expected after the second full growing season. Adverse conditions, delays in planting, and inexperienced planters may result in a second growing season survival of 60% or less.
3. Where natural seeding is reasonably reliable, natural reforestation can be considered and planting reduced, EXCEPT where mixed hardwood and conifer areas have been harvested. Reforestation of the mixed stands requires pure conifer plantations proportional in area to the percentage of conifer trees to hardwoods in the area prior to the harvest. Conifer plantations can be managed to control hardwoods and maintain growth.
4. Landowners may follow approved alternate reforestation plans or approved supplemental reforestation plans in lieu of specific rule requirements.
5. Lower stocking levels may be approved where the timber growing capacity of the site is reasonably utilized with less trees per acre than the minimum stated in the rules.

**Table 6.1 Stocking and spacing guide**

Target Trees Per Acre	DBT*	At 80% Survival Trees Needed	DBT*	At 70% Survival Trees Needed	DBT*	At 60% Survival Trees Needed	DBT*
100	20.9	125	18.7	143	17.4	166	16.2
120	19.0	150	17.0	171	16.0	200	14.8
150	17.0	187	15.3	214	14.3	250	13.2
190	15.1	237	13.6	271	12.7	317	11.7
240	13.5	300	12.0	343	11.3	400	10.4
300	12.0	375	10.8	429	10.1	500	9.3

*\*DBT=Distance Between Trees in feet.*

## Section 7 Guidelines for Riparian Management Zones

This manual contains guidance for planning forest practices management in riparian management zones adjacent to Type S and F Waters and near sensitive sites associated with Type Np Waters. The guidance supplements WAC 222-30-021 and WAC 222-30-022, the rules that regulate forest practices in forest lands adjacent to water for Western Washington and Eastern Washington riparian management zones. The manual uses the term “RMZ rules” to describe those rules.

There are terms in this manual that are familiar to people who routinely work in Washington State’s forest practices, but are unfamiliar to others. Examples are the water types, (“Type S”, “Type F”, “Type Np”), “bankfull width”, “channel migration zone”, “core zone”, and “inner zone.” Please refer to definitions in chapter 222-16 WAC for these and other forest practices terms used in this manual.

PART 1. IMPLEMENTING THE WESTERN WASHINGTON RMZ RULES.....	1
1.1 INTRODUCTION .....	1
1.2 WESTERN WASHINGTON RMZs FOR TYPE S AND F WATERS: INSTRUCTIONS FOR COMPLETING A STAND ANALYSIS AND HARVEST OPTION EVALUATION.....	2
PART 2. IMPLEMENTING THE EASTERN WASHINGTON RMZ RULES .....	4
2.1 INTRODUCTION .....	4
2.2 EASTERN WASHINGTON RMZs FOR TYPE S AND F WATERS: INSTRUCTIONS FOR COMPLETING A STAND ANALYSIS AND DETERMINING LEAVE TREES. ....	4
PART 3. IDENTIFYING SENSITIVE SITES ALONG TYPE NP WATERS IN WESTERN AND EASTERN WASHINGTON .....	5
3.1 HEADWALL SEEPS .....	5
3.2 SIDE-SLOPE SEEPS .....	6
3.3 TYPE NP INTERSECTIONS .....	6
3.4 HEADWATER SPRINGS .....	7
3.5 ALLUVIAL FANS.....	7
APPENDIX A TREE DATA COLLECTION FORM.....	9
APPENDIX B EXAMPLE OF DESIRED FUTURE CONDITION WORKSHEET DATA ENTRY PAGE AND SUMMARY PAGES .....	10
APPENDIX C EASTERN WASHINGTON BASAL AREA AND LEAVE TREE TABLES.....	16
APPENDIX D EASTERN WASHINGTON RMZs, TYPE S AND F WATERS .....	21

### PART 1. IMPLEMENTING THE WESTERN WASHINGTON RMZ RULES

#### 1.1 Introduction

The Western Washington RMZ rules are in WAC 222-30-021. Harvest is permitted within the inner zone of an RMZ adjacent to a Type S or F Water in Western Washington only if the timber stand exceeds the “stand requirement” described in WAC 222-30-021(1):

*“Stand requirement” means a number of trees per acre, the basal area and the proportion of conifer in the combined inner zone and adjacent core zone so that the growth of trees would meet desired future conditions.*

The basal area target for a 140 year old stand is 325 square feet per acre. To find out if your timber stand exceeds the stand requirement (and if you will be permitted to harvest trees within the inner zone of the RMZ) you must collect information on all of the trees in the core and inner zones of your harvest unit and enter it into a web-based Desired Future Condition Worksheet.

Please note:

- Shade must be provided as described in WAC 222-30-040 regardless of harvest opportunities in the RMZ inner and outer zones. Shade requirements apply within the first 75 feet from the outer edge of the bankfull width or channel migration zone, in addition to the RMZ rules. For guidance, see Board Manual Section 1 for determining adequate shade.
- Forest lands in the high elevation timber habitat type in Eastern Washington are subject to the same stand requirements as for Western Washington riparian management zones. You should follow this part (Part 2) of the manual if your harvest unit is in this timber habitat type.

### **1.2 Western Washington RMZs for Type S and F Waters: Instructions for completing a stand analysis and harvest option evaluation.**

Harvest is permitted in the inner zone of the RMZ only if a stand exceeds the “stand requirement” described in WAC 222-30-021(1).<sup>1</sup> Riparian prescriptions are dependent on site productivity, stand composition (percent conifer, trees per acre, and basal area per acre) and stand age.

To determine your inner zone harvest opportunity, you will use the Department of Natural Resources’ web-based computer program to enter your tree data. The program will calculate and report if your stand exceeds the stand requirement, whether you will be permitted to harvest in the inner zone, and what your harvest options are.

Appendix B contains images you will see when working in the web-based Desired Future Condition Worksheet. After you enter site information and tree data, the program will provide several DFC summary pages showing your harvest options.

#### What you will need to do before data entry.

You will need to measure the diameters of the trees and count all trees in the core zone and inner zone in the 6-inch diameter class and larger. You may use the Tree Data Collection Form in Appendix A to gather your tree information.

To gather your tree information:

- Count trees by diameter class in the **50-foot core zone**;  
and

---

<sup>1</sup> If your stand does not exceed the stand requirement, harvest will still be allowed in the outer zone as long as the required leave trees specified in WAC 222-30-021(1)(c) are left and the appropriate zone widths are used. The zone widths are specified in the table labeled “No inner zone management RMZ widths for Western Washington” in WAC 222-30-021(1)(b).

- Count trees by diameter class in an **inner zone of the following width** (in feet) according to your harvest unit's site class and stream size:

site class	small streams ( $\leq 10$ feet)	large streams ( $>10$ feet)
I	84	100
II	64	78
III	44	55
IV	23	33
V	10	18

In addition to gathering your tree information, you will need the following information at hand for data entry into the Desired Future Condition Worksheet. (Additional instructions for data entry are available on the worksheet by clicking on "Getting Started" in the upper left of the area of the screen.)

- The legal description.
- Site class. To determine site class, download a Forest Practices Application/ Notification activity map for your area and activate the site class layer. Go to [http://www.dnr.wa.gov/BusinessPermits/Topics/ForestPracticesApplications/Pages/fp\\_for\\_ms.aspx](http://www.dnr.wa.gov/BusinessPermits/Topics/ForestPracticesApplications/Pages/fp_for_ms.aspx), and under the heading, "Forest Practices Application/Notification", click on "Print an activity map." After navigating to the location of your activity, in the left corner under the "Select a map" button, choose Site Class Map. In the upper right corner, click on the "Legend" button to find the site class of your activity.
- Major species. This refers to conifer species and is determined by stem count. If there are more Douglas fir stems than other conifer tree species, choose Douglas fir. If there are fewer Douglas fir stems than other conifer species, choose western hemlock.
- Stream size. Choose "small" for a stream with an average bankfull width of  $\leq 10$  feet, and "large" for a stream with an average bankfull width  $> 10$  feet. If you need guidance on determining bankfull width, please refer to Board Manual Section 2.
- RMZ length.
- DBH class. Tree data is to be entered for each 2-inch diameter class, no smaller than the 6-inch diameter class.
- DBH classes total. This is the total number of diameter classes entered for each zone. For example, if you enter tree data for DBH classes 6, 8, 10, 18, and 20, the DBH classes total is 5.
- Stand age. Stand age is the average age of the dominant conifer trees in a stand. Stand age can be estimated by increment boring. Bore the dominant conifer trees within the riparian zone and average the growth ring counts. Increment boring shall be made at 4.5 feet above the ground on the uphill side of the tree. Add five years to the growth ring count to account for growth up to boring height. Stand age can also be determined from a landowner inventory or stand history if available.

You must complete a separate Desired Future Condition Worksheet for each stream or stream segment within your project, and attach DFC summary pages for each stream or stream segment to your forest practices application.

#### How to access the Department of Natural Resources' web-based Desired Future Condition Worksheet.

Now that you have gathered all of your stand information, you can easily enter it into the Desired

Future Condition Worksheet. Access the worksheet at <http://fortress.wa.gov/dnr/dfc/>, or go to <http://www.dnr.wa.gov>, and navigate as follows:

Under Business & Permits, click on Forest Practices;

Under Topics, click on Forest Practices Forms and Instructions;

Scroll down to and click on DFC Worksheet Version 3.0.

You may click on “Getting Started” for instructions on the appropriate data to be entered into each field and for information on evaluating your harvest options.

## **PART 2. IMPLEMENTING THE EASTERN WASHINGTON RMZ RULES**

### **2.1 Introduction**

The Eastern Washington RMZ rules are in WAC 222-30-022. The zone widths are shown in the beginning of the rule. The inner zone width for forest land adjacent to streams  $\leq 15$  feet wide is 45 feet, and for forest land adjacent to streams  $> 15$  feet wide is 70 feet, in addition to the 30-foot core zone. Timber harvest rules for Eastern Washington RMZs vary by timber habitat type (Ponderosa pine, mixed conifer, and high elevation), and by site index in the case of the mixed conifer habitat type.

For the high elevation timber habitat type ( $\geq 5,000$  feet elevation) the stand must exceed 325 square feet per acre for all site classes in the combined core and inner zone. This stand requirement is the same as for Western Washington Type S and F Waters, and the guidelines in Part 1 should be followed for this timber habitat type.

Please note: Shade must be provided as described in WAC 222-30-040 regardless of harvest opportunities in the RMZ inner and outer zones. Shade requirements apply within the first 75 feet from the outer edge of the bankfull width or channel migration zone, in addition to the RMZ rules. For guidance, see Board Manual Section 1 for determining adequate shade.

### **2.2 Eastern Washington RMZs for Type S and F Waters: Instructions for completing a stand analysis and determining leave trees.**

This manual offers two tools to help you to determine whether harvest is likely to be permitted in the inner zone of your Ponderosa pine or mixed conifer habitat type - and if so, the trees that must be left after harvest.

- Appendix C contains a set of tables specific to each timber habitat and stream type that give stand requirement and leave tree estimates for a variety of stream RMZ lengths. You may compare these estimates with your stand characteristics to get a general idea whether harvest is likely to be allowed in your stand. This is optional.
- Appendix D contains step-by-step guidelines to conduct a stand analysis and determine your harvest opportunity and leave tree requirements.

### PART 3. IDENTIFYING SENSITIVE SITES ALONG TYPE NP WATERS IN WESTERN AND EASTERN WASHINGTON

The rules for protecting sensitive sites for Western Washington and for Eastern Washington are in WAC 222-222-30-021(2)(b) and WAC 222-30-022(2)(b)(ii), respectively. Sensitive sites are areas near or adjacent to Type Np Waters that are protected from forestry-related activities because they provide important habitat and function for aquatic resources. They are:

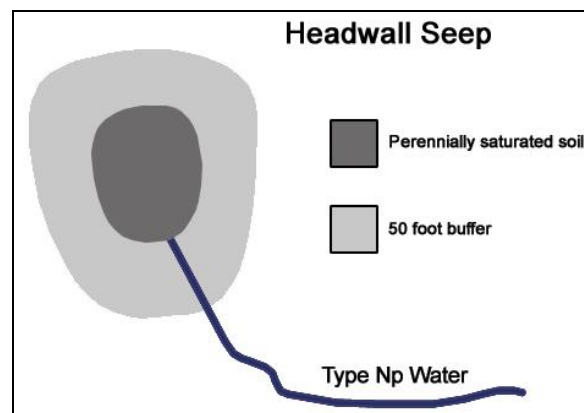
- headwall seeps
- side-slope seeps
- headwater springs
- Type Np intersections
- alluvial fans

Each of these features is defined under “sensitive sites” in WAC 222-16-010; however, their characteristics are described in more detail below to help you identify and protect them.

#### 3.1 Headwall Seeps

Timber harvest is not allowed within 50 feet of the outer perimeter of soil perennially saturated from a headwall seep in Western Washington and under the clearcut harvest strategy in Eastern Washington. Headwall seeps are wetted areas located at the base of cliffs or other steep areas, and where present are found at the head of Type Np Waters. Headwall seeps connect to the stream channel via overland flow, and are often characterized by loose substrate or fractured bedrock. Water occurs at or near the surface of headwall seeps year-round. Headwall seeps that are associated with the spray from falling water may be especially important to amphibians.

The vegetation communities associated with headwall seeps are similar to those of wetlands, and may contain some or all of the following taxa: sedges, rushes, horsetails, willows, devils club, salmonberry, skunk cabbage, piggyback plant, lady fern, leafy liverwort, black cottonwood, Oregon ash, or red alder. Headwall seeps may have tree canopy gaps that may be visible from aerial photos, although the presence or absence of seeps must be confirmed using ground-based observation.

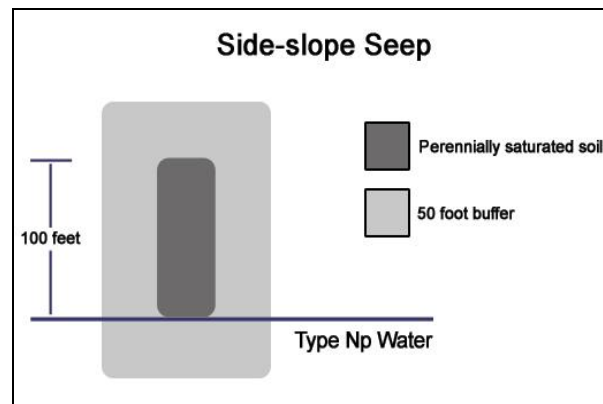


### 3.2 Side-slope Seeps

Timber harvest is not allowed within 50 feet of the outer perimeter of soil perennially saturated from a side-slope seep in Western Washington and under the clearcut harvest strategy in Eastern Washington. Under the partial cut harvest strategy in Eastern Washington, side-slope seeps must be protected with a 50-foot partial cut buffer that meets the basal area and leave tree requirements listed in WAC 222-30-022(2)(b)(i), subsections (A), (B), and (C).

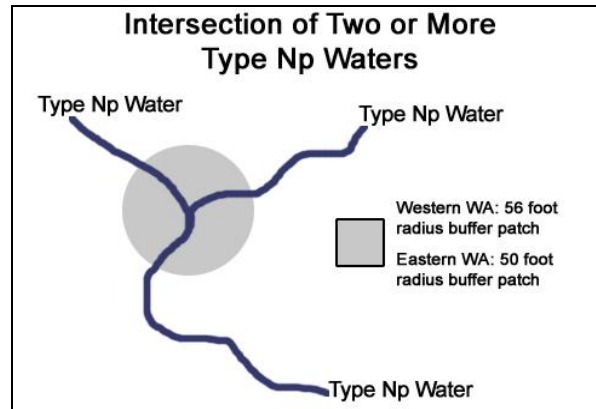
Side-slope seeps are wetted areas adjacent to Type Np Waters. For the purposes of the Forest Practices rules, and where present, side-slope seeps originate within 100 feet of the stream channel and flow without a defined channel. Side-slope seeps exist where valley slopes exceed 20%. Like headwall seeps, side-slope seeps may be characterized by loose substrate or fractured bedrock with water present at or near the surface year-round. Delivery of water from side-slope seeps to the stream channel is visible by someone standing at or near the stream. Side-slope seeps that are associated with the spray from falling water may be especially important to amphibians.

The vegetation communities associated with side-slope seeps are similar to those of wetlands, and may contain some or all of the following taxa: sedges, rushes, horsetails, willows, devils club, salmonberry, skunk cabbage, piggyback plant, lady fern, leafy liverwort, black cottonwood, Oregon ash, or red alder. Side-slope seeps may have tree canopy gaps that may be visible from aerial photos, although the presence or absence of seeps must be confirmed using ground-based observation.



### 3.3 Type Np Intersections

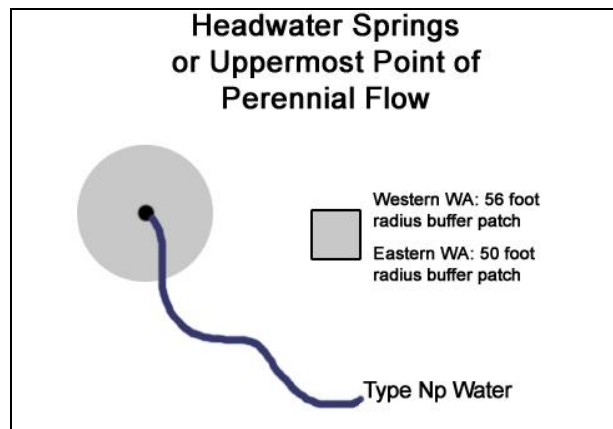
Timber harvest is not allowed within a 56-foot radius in Western Washington or a 50-foot radius in Eastern Washington, centered on the intersection of two or more Type Np Waters. Type Np intersections occur where two Type Np streams join.



### 3.4 Headwater Springs

Timber harvest is not allowed within a 56-foot radius patch of a headwater spring in Western Washington, or within a 50-foot radius patch of a headwater spring in Eastern Washington. The radius patch is centered on the initiation point of perennial flow of a headwater spring, or in the absence of a spring, the uppermost point of perennial flow.

Headwater springs are permanent springs that are located at the head of perennial channels where present and form the upper extent of a Type Np Water. Where these springs are present, they provide especially important amphibian habitat. During low flow periods, they are often observed as an abrupt small pool or riffle with flow where the channel is immediately and persistently dry above. Vegetation characteristics may not differ markedly from the taxa upstream and downstream. However, vegetation similar to that of headwall seeps and side-slope seeps may be present.



### 3.5 Alluvial Fans

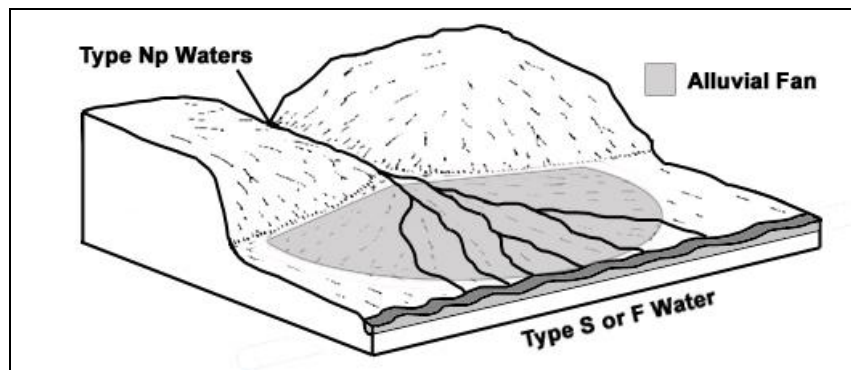
Timber harvest is not allowed on alluvial fans in Western Washington, or within 50 feet of an alluvial fan in Eastern Washington under the clearcut harvest strategy. An alluvial fan is defined as, “A low, outspread flat to gently sloping mass of loose rock material, shaped like an open fan..., deposited by a stream at the place where it issues from a narrow mountain valley or gorge



upon a plain or broad valley...” (Jackson 1997).<sup>2</sup> An alluvial fan will form as a result of a change in slope at the mouth of a stream. As the stream issues onto a plain or broad valley it spreads out and slows down. Any solids entrained in the stream tend to settle out onto the gentle slopes of the plain or broad valley. These solids block the flow of the stream and cause the flow to change course. Therefore, due to the gentle topography on the plain or in the broad valley, alluvial fans are susceptible to stream channel migration. The fan shape forms by radial spreading as the stream migrates back and forth on the gentle slope and solid material is deposited in equal layers. These deposits gradually build up the surface of the fan.

As a landform, alluvial fans are steepest at their high point (or apex) at the mouth of the narrow mountain valley or gorge from which the stream issues, and slope gently in a slightly mounded manner outward with gradually decreasing grade. Stream channels on a fan can vary and change without notice vacating established channels or scouring out new ones. A landslide in a narrow stream channel at or above the apex can influence the stream course by pre-depositional erosion and downcutting. It is the deposition of solids that most influences the direction a stream will take on the body of a fan. When a channel is blocked by deposition, the stream will change direction. For this reason, braided channels are common on alluvial fans.

Alluvial fans may build up over thousands of years and be covered by trees. The roots of these trees can serve to stabilize fan channels.



<sup>2</sup> Jackson, J. A., 1997, *Glossary of Geology, 4<sup>th</sup> Edition*, American Geological Institute, Alexandria, Virginia, 769 pp..

**APPENDIX A TREE DATA COLLECTION FORM**

Western Washington RMZs, Type S and F Waters

This form is provided for your convenience to record core zone and inner zone tree data in preparation for entering data in the web-based Desired Future Condition Worksheet.

- Count all trees in the core and inner zones for each 2-inch diameter class, no smaller than the 6-inch diameter class.
- You will need enough copies to compile tree data for each stream and stream segment.

<b>Tree Data Collection Form for Western Washington RMZs</b>				
Preparation for entering stand data in the web-based DFC Worksheet.				
<b>Diameter class</b> diameter measured at breast height (dbh)	CORE ZONE		INNER ZONE	
	<b>Number of conifers per dbh class</b>	<b>Number of hardwoods per dbh class</b>	<b>Number of conifers per dbh class</b>	<b>Number of hardwoods per dbh class</b>
6 (5 - 6.9 inches)				
8 (7 - 8.9 inches)				
10 (9 - 10.9 inches)				
12 (11 - 12.9 inches)				
14 (13 - 14.9 inches)				
16 (15 - 16.9 inches)				
18 (17 - 18.9 inches)				
20 (19 - 20.9 inches)				
22 (21 - 22.9 inches)				
24 (23 - 24.9 inches)				
26 (25 - 26.9 inches)				
28 (27 - 28.9 inches)				
30 (29 - 30.9 inches)				
32 (31 - 32.9 inches)				
34 (33 - 34.9 inches)				
36 (35 - 36.9 inches)				
38 (37 - 38.9 inches)				
40 (39 - 40.9 inches)				
42 (41 - 42.9 inches)				
44 (43 - 44.9 inches)				
46 (45 - 46.9 inches)				
48 (47 - 48.9 inches)				
50 (49 - 50.9 inches)				
52 (51 - 52.9 inches)				
54 (53 - 54.9 inches)				
56 (55 - 56.9 inches)				
58 (57 - 58.9 inches)				
60 (59 - 60.9 inches)				

## APPENDIX B EXAMPLE OF DESIRED FUTURE CONDITION WORKSHEET DATA ENTRY PAGE AND SUMMARY PAGES

### Desired Future Condition Worksheet Data Entry Page Example: A 100-foot RMZ length on a site class III harvest unit, small stream

**Desired Future Condition Worksheet | Version 3.0**

[Getting Started](#) | [Help](#) | [About This Version](#) | [Retrieve Data](#) | [Reset Form](#)

**General Information** ?

Landowner:

Address:

Phone:

Project Name:

Legal Description:

**Site Information** ?

Stream Segment:

Site Class:

Major Species:

Stream Size:  Small  Large

RMZ Length (ft):

Eastside High Altitude RMZ?  Yes

**Core Zone Stand Table** ?

Stand Age:

DBH Classes Total:  Add Data

Enter your data in the grid and proceed to the Inner Zone Stand Table.

Core Zone Acres	<input type="text" value="0.11"/>	Basal Area / Acre	<input type="text" value="315.13"/>
Trees / Acre	<input type="text" value="592.42"/>	Percent Conifer	<input type="text" value="90.95"/>

**Inner Zone Stand Table** ?

Stand Age:

Widest Inner Zone Width:

DBH Classes Total:  Add Data

Enter your data in the grid and proceed to the 'Calculate' button.

Inner Zone Acres	<input type="text" value="0.1"/>	Basal Area / Acre	<input type="text" value="567.99"/>
Trees / Acre	<input type="text" value="516.64"/>	Percent Conifer	<input type="text" value="95.33"/>

DBH Class	Conifer	Hardwood
6	18	6
8	10	6
10	20	0
18	6	0
20	2	0

Calculate
- Minimize Grid

DBH Class	Conifer	Hardwood
8	10	3
12	13	2
16	8	0
18	10	0
20	5	0

Calculate
- Minimize Grid

Required DFC of the Combined Core and Inner Zones at age 140: 325

Projected B.A. of Core Zone at 140: 402.63 (24% over Required B.A.)

Projected B.A. of Inner Zone at 140: 437.7 (35% over Required B.A.)

Projected B.A. of Combined Core and Inner Zones at Age 140: 420.16 (29% over Required B.A.)

### Example Screen image after data entry: Option 1

Forest Practices Review System | Privacy Policy
WASHINGTON STATE DEPARTMENT OF  
**Natural Resources**

HOME
RECREATION & PUBLIC INFORMATION
BUSINESS & PERMITS
SCIENCE & ENVIRONMENT
CONTACT DNR
ABOUT DNR

## Desired Future Condition Worksheet | Version 3.0

[Getting Started](#) | [Help](#) | [About This Version](#) | [Retrieve Data](#) | [Reset Form](#)

**Option 1: Thinning from below** ?

Stream
  Core Zone
  Inner Zone
  Outer Zone

50

 Leave the 6 largest conifer trees. The number of leave trees per acre will equal or exceed 57 trees.

93

 Need 3 Riparian leave trees. (May be reduced by trees in CMZ or placement. See guidelines)

140

Suggested Thinning:

DBH	Conifer		Hardwood	
	Original	After Thinning	Original	After Thinning
8	10	0	3	0
12	13	0	2	0
16	8	0	0	0
18	10	1	0	0
20	5	5	0	0

**Option 1 Information** ?

Stand meets DFC.

Projected Basal Area	343
Required Basal Area	235

After Thinning:

Average DBH	10.8
Basal Area / Acre	128.41
Trees / Acre (Conifer)	60.78
Minimum % Conifer	95.33
% Conifer	100

Outer Zone Width	47
Outer Zone Acres	0.11

**Option 2: Leaving trees closest to stream** - [Click to View](#) ?

Save & Print All Results

Edit Input Data

### Example Screen image after data entry: Option 2

The screenshot displays the 'Forest Practices Application Review System' interface. At the top, there is a navigation bar with the Washington State Department of Natural Resources logo and links for HOME, RECREATION & PUBLIC INFORMATION, BUSINESS & PERMITS, SCIENCE & ENVIRONMENT, CONTACT DNR, and ABOUT DNR. The main heading is 'Desired Future Condition Worksheet | Version 3.0', with sub-links for Getting Started, Help, About This Version, Retrieve Data, and Reset Form.

Two options are presented: 'Option 1: Thinning from below - Click to View' and 'Option 2: Leaving trees closest to stream'. The 'Option 2 Information' panel indicates that the stand meets DFC and no harvest is allowed within 80 feet of the stream BFW or CMZ. It shows input fields for 'Outer Zone Width' (46) and 'Outer Zone Acres' (0.11).

The riparian zone diagram includes a legend for Stream (blue), Core Zone (orange), Floor Zone (light orange), Inner Zone (yellow), and Outer Zone (green). The diagram shows four distance markers from the stream:

- 50:** Credit of 9.1 square feet of basal area available for outer zone.
- 80:** Need 1 Riparian leave trees in this area with a minimum 12-inch DBH.
- 94:** Need 3 Riparian leave trees in this area. An additional 9.1 sqft of basal area may be removed as long as 2 riparian leave trees are left.
- 140:** (No text description provided for this distance).

At the bottom, there are buttons for 'Save & Print All Results' and 'Edit Input Data'.

**Example  
DFC Summary Printout Pages**

## DFC Summary Page

### DFC Program Version 3.0

**DFC Run Number:** 1301**Landowner:** DNR**Address:** OLYMPIA**Phone:** 360-555-2315**Project Name:** WADDLE CREEK**Stream Segment:** 1**Legal Desc:** Section: 17 Township: 21 Range: 3 East**Stream Size:** SMALL**Site Class:** 3**Major Species:** DOUGLAS FIR**RMZ Length:** 100**Eastside Option:** NO**Core Pre-Harvest Zone Summary****Acres:** 0.11**Total Age of Overstory:** 55**Trees / Acre:** 592.42**Basal Area Acre:** 315.13**Percent Conifer:** 90.95**Inner Zone Pre-Harvest Summary****Acres (Option 1):** 0.1**Total Age of Overstory:** 55**Trees / Acre:** 516.64**Basal Area Acre:** 567.99**Percent Conifer:** 95.33**Core Zone Stand Table**

DBH	Conifer	Hardwood
6	18	6
8	10	6
10	20	0
18	6	0
20	2	0

**Inner Zone Stand Table**

DBH	Conifer	Hardwood
8	10	3
12	13	2
16	8	0
18	10	0
20	5	0

**Required DFC of the Combined Core and Inner Zones at age 140:** 325**Projected B.A. of Core Zone at 140 as a % of DFC:** 402.63 (24% over Required B.A.)**Projected B.A. of Inner Zone at 140 as a % of DFC:** 437.7 (35% over Required B.A.)**Projected B.A. of Combined Core and Inner Zones at Age 140:** 420.16 (29% over Required B.A.)

**Example**  
**DFC Summary Printout Pages, continued – Option 1**

# Option 1

## DFC Program Version

**Landowner:** DNR  
**Address:** OLYMPIA  
**Phone:** 360-555-2315

**Project Name:** WADDLE CREEK  
**Stream Segment:** 1  
**Legal Desc:** Section: 17 Township: 21 Range: 3 East

### Inner Zone post-thinning Statistics

**Trees / Acre:** 60.78

**Basal Area / Acre:** 128.41

**Percent Conifer:** 95.33

Required Basal Area of Thinned Inner Zone at age 140 must be at least 234.74 Sq. Ft / Acre at age 140.

Projected Basal Area of Thinned Inner Zone at age 140 will be at least 343.21 Sq. Ft / Acre at age 140.

The inner zone for Option 1 is from 50 to 93 feet.

### Inner Zone Stand Table

DBH	Conifers: Can Be Cut	Required Leave Trees	Hardwood: Can Cut All	Required Leave Trees	Conifer BA Cut	Conifer BA Leave
8	10	0	3	0	3.49	0
12	13	0	2	0	10.21	0
16	8	0	0	0	11.17	0
18	9	1	0	0	15.9	1.77
20	0	5	0	0	0	10.91
<b>Totals</b>					<b>40.78</b>	<b>12.68</b>

**Option 1 Outer Zone Width:** 47

**Option 1 Outer Zone Acres:** 0.11

**Example**  
**DFC Summary Printout Pages, continued – Option 2**

## Option 2

### DFC Program Version

**Landowner:** DNR  
**Address:** OLYMPIA  
**Phone:** 360-555-2315

**Project Name:** WADDLE CREEK  
**Stream Segment:** 1  
**Legal Desc:** Section: 17 Township: 21 Range: 3 East

**Inner Zone Floor:** 50 to 80 feet, no harvesting allowed.

**ClearCut Inner Zone :** 80 to 94 feet, Need 1 Riparian leave trees in this area. Leave trees must be at least 12 inches at DBH.

**Outer Zone:** 94 to 140 feet, Need 3 Riparian leave trees in this area.

**Note:** An additional 9.1 Sq. Ft. of basal area may be removed from the Outer Zone as long as 2 riparian leave trees are left.

**Option 2 Outer Zone Width:** 46

**Option 2 Outer Zone Acres:** 0.11



## APPENDIX C EASTERN WASHINGTON BASAL AREA AND LEAVE TREE TABLES

This appendix contains a set of tables specific to each timber habitat and stream type. The tables provide basal area thresholds and leave tree estimates for a variety of RMZ lengths. You may compare these estimates with your stand characteristics to get a general idea whether harvest is likely to be allowed in your stand.

Inner zone acreage calculations in the tables are rounded to the nearest hundredth (0.01) and tree and basal area counts are rounded to the nearest whole number. Numbers greater than or equal to 0.5 are rounded up, numbers less than or equal to 0.4 are rounded down.

### A. Type S and F Waters: Tables for Small Streams (streams $\leq$ 15 feet in bankfull width)

- Inner zone width is 45 feet.
- 1000 feet RMZ length = approximately 1.03 acre

*Table A1. Ponderosa pine (elevation  $\leq$  2500 feet)*

Length of RMZ (feet)	1000	900	800	700	600	500	400	300	200	100
Approximate inner zone acres	1.03	0.93	0.82	0.72	0.62	0.52	0.41	0.31	0.21	0.10
21 largest leave trees per acre	22	20	17	15	13	11	9	7	4	2
29 additional trees $\geq$ 10" dbh	30	27	24	21	18	15	12	9	6	3
Required leave trees basal area per acre (square feet)	62	56	49	43	37	31	25	19	13	6
Basal area upper threshold (square feet)	113	102	90	79	68	57	45	34	23	11

*Table A2. Mixed conifer (elevation 2,500 to 5,000 feet) - Low site index (less than 90)*

Length of RMZ (feet)	1000	900	800	700	600	500	400	300	200	100
Approximate inner zone acres	1.03	0.93	0.82	0.72	0.62	0.52	0.41	0.31	0.21	0.10
21 largest leave trees per acre	22	20	17	15	13	11	9	7	4	2
29 additional trees $\geq$ 10" dbh	30	27	24	21	18	15	12	9	6	3
Required leave trees basal area per acre (square feet)	72	65	57	50	43	36	29	22	15	7
Basal area upper threshold (square feet)	113	102	90	79	68	57	45	34	23	11

**Table A3. Mixed conifer (elevation 2,500 to 5,000 feet) - Medium site index (90-110)**

Length of RMZ (feet)	1000	900	800	700	600	500	400	300	200	100
Approximate inner zone acres	1.03	0.93	0.82	0.72	0.62	0.52	0.41	0.31	0.21	0.10
21 largest leave trees per acre	22	20	17	15	13	11	9	7	4	2
29 additional trees $\geq$ 10" dbh	30	27	24	21	18	15	12	9	6	3
Required leave trees basal area per acre (square feet)	93	84	74	65	56	47	37	28	19	9
Basal area upper threshold (square feet)	134	121	107	94	81	68	53	40	27	13

**Table A4. Mixed conifer (elevation 2,500 to 5,000 feet) - High site index (greater than 110)**

Length of RMZ (feet)	1000	900	800	700	600	500	400	300	200	100
Approximate inner zone acres	1.03	0.93	0.82	0.72	0.62	0.52	0.41	0.31	0.21	0.10
21 largest leave trees per acre	22	20	17	15	13	11	9	7	4	2
29 additional trees $\geq$ 10" dbh	30	27	24	21	18	15	12	9	6	3
Required leave trees basal area per acre (square feet)	93	84	74	65	56	47	37	28	19	9
Basal area upper threshold (square feet)	155	140	123	108	93	78	62	47	32	15

**B. Type S and F Waters: Tables for Large Streams (>15 feet in bankfull width)**

- Inner zone width is 70 feet.
- 1000 feet = 1.61 acres

**Table B1. Ponderosa pine (elevation  $\leq$  2500 feet)**

Length of RMZ (feet)	1000	900	800	700	600	500	400	300	200	100
Approximate inner zone acres	1.61	1.45	1.29	1.13	0.97	0.81	0.64	0.48	0.32	0.16
21 largest leave trees per acre	34	30	27	24	20	17	13	10	7	3
29 additional trees $\geq$ 10" dbh	47	42	37	33	28	23	19	14	9	5
Required leave trees basal area per acre (square feet)	97	87	77	68	58	49	38	29	19	10
Basal area upper threshold (square feet)	177	160	142	124	107	89	70	53	35	18

**Table B2. Mixed conifer (elevation 2,500 to 5,000 feet) - Low site index (less than 90)**

Length of RMZ (feet)	1000	900	800	700	600	500	400	300	200	100
Approximate inner zone acres	1.61	1.45	1.29	1.13	0.97	0.81	0.64	0.48	0.32	0.16
21 largest leave trees per acre	34	30	27	24	20	17	13	10	7	3
29 additional trees $\geq$ 10" dbh	47	42	37	33	28	23	19	14	9	5
Required leave trees basal area per acre (square feet)	113	102	90	79	68	57	45	34	22	11
Basal area upper threshold (square feet)	177	160	142	124	107	89	70	53	35	18

**Table B3. Mixed conifer (elevation 2,500 to 5,000 feet) - Medium site index (90-110)**

Length of RMZ (feet)	1000	900	800	700	600	500	400	300	200	100
Approximate inner zone acres	1.61	1.45	1.29	1.13	0.97	0.81	0.64	0.48	0.32	0.16
21 largest leave trees per acre	34	30	27	24	20	17	13	10	7	3
29 additional trees $\geq$ 10" dbh	47	42	37	33	28	23	19	14	9	5
Required leave trees basal area per acre (square feet)	145	131	116	102	87	73	58	43	29	14
Basal area upper threshold (square feet)	209	189	168	147	126	105	83	62	42	21

**Table B4. Mixed conifer (elevation 2,500 to 5,000 feet) - High site index (greater than 110)**

Length of RMZ (feet)	1000	900	800	700	600	500	400	300	200	100
Approximate inner zone acres	1.61	1.45	1.29	1.13	0.97	0.81	0.64	0.48	0.32	0.16
21 largest leave trees per acre	34	30	27	24	20	17	13	10	7	3
29 additional trees $\geq$ 10" dbh	47	42	37	33	28	23	19	14	9	5
Required leave trees basal area per acre (square feet)	145	131	116	102	87	73	58	43	29	14
Basal area upper threshold (square feet)	242	218	194	170	146	122	96	72	48	24

**C. Type Np Waters**

- Inner zone width is 50 feet.
- 1000 feet = approximately 1.15 acres

**Table C1. Ponderosa pine (elevation ≤ 2500 feet)**

Length of RMZ (feet)	1000	900	800	700	600	500	400	300	200	100
Approximate inner zone acres	1.15	1.04	0.92	0.81	0.69	0.58	0.46	0.35	0.23	0.12
10 largest leaf trees per acre	12	10	9	8	7	6	5	4	2	1
40 additional trees ≥ 10" dbh	46	42	37	32	28	23	18	14	9	5
Required leaf trees basal area per acre (square feet)	69	62	55	49	41	35	28	21	14	7
Basal area upper threshold (square feet)	127	114	101	89	76	64	51	39	25	13

**Table C.2. Mixed conifer (elevation 2,500 to 5,000 feet) - Low site index (less than 90)**

Length of RMZ (feet)	1000	900	800	700	600	500	400	300	200	100
Approximate inner zone acres	1.15	1.04	0.92	0.81	0.69	0.58	0.46	0.35	0.23	0.12
10 largest leaf trees per acre	12	10	9	8	7	6	5	4	2	1
40 additional trees ≥ 10" dbh	46	42	37	32	28	23	18	14	9	5
Required leaf trees basal area per acre (square feet)	81	73	64	57	48	41	32	25	16	8
Basal area upper threshold (square feet)	127	114	101	89	76	64	51	39	25	13

**Table C3. Mixed conifer (elevation 2,500 to 5,000 feet) - Medium site index (90-110)**

Length of RMZ (feet)	1000	900	800	700	600	500	400	300	200	100
Approximate inner zone acres	1.15	1.04	0.92	0.81	0.69	0.58	0.46	0.35	0.23	0.1
10 largest leaf trees per acre	12	10	9	8	7	6	5	4	2	1
40 additional trees ≥ 10" dbh	46	42	37	32	28	23	18	14	9	4
Required leaf trees basal area per acre (square feet)	104	94	83	73	62	52	41	32	21	11
Basal area upper threshold (square feet)	150	135	120	105	90	75	60	46	30	16

**Table C4. Mixed conifer (elevation 2,500 to 5,000 feet) - High site index (greater than 110)**

<b>Length of RMZ (feet)</b>	<b>1000</b>	<b>900</b>	<b>800</b>	<b>700</b>	<b>600</b>	<b>500</b>	<b>400</b>	<b>300</b>	<b>200</b>	<b>100</b>
<b>Approximate inner zone acres</b>	1.15	1.04	0.92	0.81	0.69	0.58	0.46	0.35	0.23	0.1
<b>10 largest leave trees per acre</b>	12	10	9	8	7	6	5	4	2	1
<b>40 additional trees <math>\geq</math> 10" dbh</b>	46	42	37	32	28	23	18	14	9	4
<b>Required leave trees basal area per acre (square feet)</b>	104	94	83	73	62	52	41	32	21	11
<b>Basal area upper threshold (square feet)</b>	173	156	138	122	104	87	69	53	35	18

## APPENDIX D EASTERN WASHINGTON RMZS, TYPE S AND F WATERS

This appendix contains guidelines for assessing the inner zone timber and associated basal areas for Eastern Washington RMZs adjacent to Type S and F Waters. The rules for Eastern Washington RMZs vary by timber habitat type:

- Ponderosa pine timber habitat type (stands below 2,500 feet in elevation);
- Mixed conifer timber habitat type (stands 2,500 to 5,000 feet in elevation); and
- High elevation timber habitat type (stands above 5,000 feet).

The guidelines in this appendix are for the Ponderosa pine and mixed conifer types. For the high elevation timber habitat type, the stand requirement is the same as for Western Washington Type S and F Waters; therefore, the Western Washington guidelines (Part 2 of this manual) should be followed.

Section 1 is provided to help you calculate the basal area per acre in your stand. Harvest in the inner zone is allowed if the inner zone basal area per acre exceeds a basal area requirement. The result of your calculation in Section 1 can be compared with the basal area requirement from the rules, which you will find in Section 2 of this appendix. Comparing the basal area of the trees in your stand with the basal area requirement will help you to determine if harvest will be allowed in your stand. If so, you can refer to Section 2 to find your leave tree requirements. Then you can use Section 3 for calculating your leave trees. Section 4 provides an example of calculations for a two-acre inner zone to demonstrate how to calculate leave trees.

### **Section 1. Inner zone assessment.**

You may use Table 1 on the following page to collect tree data that will help assess whether harvest will be allowed in the inner zone.

<b>Table 1</b> <b>Inner Zone Assessment</b> Collect tree data for trees in each 2-inch diameter class, no smaller than the 6-inch diameter class.			
A	B	C	D
Diameter class diameter measured at breast height (dbh)	Basal area per tree (square feet)	Number of trees in the inner zone	Basal area per dbh class (square feet) (multiply numbers in columns B and C)
32 (31 - 32.9 inches)	5.6		
30 (29 - 30.9 inches)	4.9		
28 (27 - 28.9 inches)	4.3		
26 (25 - 26.9 inches)	3.7		
24 (23 - 24.9 inches)	3.1		
22 (21 - 22.9 inches)	2.6		
20 (19 - 20.9 inches)	2.2		
18 (17 - 18.9 inches)	1.8		
16 (15 - 16.9 inches)	1.4		
14 (13 - 14.9 inches)	1.1		
12 (11 - 12.9 inches)	0.79		
10 (9 - 10.9 inches)	0.55		
8 (7 - 8.9 inches)	0.35		
6 (5 - 6.9 inches)	0.20		

If your harvest unit contains more than one stream or stream segment, this analysis should be done separately for each segment.

**Calculate the basal area per acre in the inner zone.**

Add the basal areas in column D for a total basal area in the inner zone. \_\_\_\_\_ sq. ft.

Divide the total basal area by the acres in the inner zone.<sup>3</sup>

Total basal area \_\_\_\_\_sq. ft. ÷ \_\_\_\_\_ acres = \_\_\_\_\_ Basal area per acre

**Calculate trees per acre in the inner zone.**

Add the number of trees in column C. \_\_\_\_\_ total trees

<sup>3</sup> To calculate inner zone acres, multiply the inner zone width (45 feet for streams ≤ 15 feet, or 70 feet for streams >15 feet) by the inner zone length, then divide by 43,560: Inner zone acres = width \_\_\_\_\_ feet X length \_\_\_\_\_ feet ÷ 43,560.

Divide the total trees by acres in the inner zone.

Total trees \_\_\_\_\_ trees ÷ \_\_\_\_\_ acres = \_\_\_\_\_ trees per acre

Next, compare your inner zone basal area and trees per acre with the requirements for your timber habitat type shown in Section 2. Then use Section 3 for help in determining your leave tree requirement.

## Section 2. Basal area and leave tree requirements.

### **Ponderosa pine timber habitat type (stands below 2,500 feet in elevation).**

#### **1. Stands with high basal area.**

Basal area requirement. Harvest is allowed if the basal area is more than 110 square feet per acre for all tree species equal to or greater than 6 inches dbh in the inner zone.

Leave tree requirements. Harvest must leave at least 50 trees per acre and a basal area of at least 60 sq. ft./ac. You must select leave trees as follows:

- 21 largest trees per acre; and
- An additional 29 trees per acre that are  $\geq 10$  inches dbh
  - If there are fewer than 29  $\geq 10$ -inch dbh trees per acre, leave the 29 largest trees.
  - If there are more than 29  $\geq 10$ -inch dbh trees per acre, leave 29  $\geq 10$ -inch dbh trees per acre based on the following priority order:
    - Trees that provide shade to water;
    - Trees that lean towards the water;
    - Trees of the preferred species as defined in WAC 222-16-010;
    - Trees that are evenly distributed across the inner zone.

If more than 50 trees per acre are needed to meet the minimum leave tree basal area of 60 square feet per acre, then additional trees  $\geq 6$  inches dbh must be left. If the minimum basal area cannot be met with fewer than 100 trees that are  $\geq 6$  inches dbh, then no more than 100 trees per acre of the largest remaining trees are required to be left regardless of basal area.

#### **2. Stands with low basal area and high density.**

Basal area and density requirements. Thinning is permitted if the basal area of all species is less than 60 square feet per acre AND there are more than 100 trees per acre.

#### Leave tree requirements.

Thinning in low basal area and high density stands must leave a minimum of 100 trees per acre. The trees to be left shall be selected as follows:

- The 50 largest trees per acre; and
- An additional 50 trees per acre in the 6-inch diameter class or larger. If there are not 50 trees per acre in the 6-inch diameter class or larger, then all trees in the 6-inch diameter class or larger per acre must be left, plus the largest remaining trees to equal 50 trees per acre. Select the additional 50 trees per acre based on the following priority order:
  - Trees that provide shade to water;
  - Trees that lean towards the water;
  - Trees of the preferred species as defined in WAC 222-16-010;



Trees that are evenly distributed across the inner zone.

**Mixed conifer timber habitat type (stands 2,500 to 5,000 feet in elevation).**

The rules for the mixed conifer timber habitat type require knowledge of the site index of a harvest unit. For purposes of carrying out the RMZ rules, site indices are reported in the *Washington State Department of Natural Resources State Soil Survey* and detailed in the associated forest soil summary sheets. Contact a Department of Natural Resources (DNR) region office for site index information. If the soil survey does not report a site index for your location or it indicates noncommercial or marginal forest land, then see (3) of the definition of “site class” in WAC 222-16-010 for guidance.

**1. Stands with high basal area.**

Basal area requirement. Harvest is allowed if the total basal area of all species greater than 6 inches dbh in the inner zone is more than:

- 100 sq. ft./ac. on low site index (< 90)
- 130 sq. ft./ac. on medium site index (90 to ≤ 110)
- 150 sq. ft./ac. on high site index (> 110)

Leave tree requirements. Harvest must leave at least 50 trees per acre AND a basal area of at least:

- 70 sq. ft./ac. on low site index (< 90)
- 90 sq. ft./ac. on medium site index (90 to ≤ 110)
- 110 sq. ft./ac. on high site index (> 110)

The trees to be left shall be selected as followed:

- 21 largest trees per acre
- An additional 29 trees per acre that are ≥ 10 inches dbh
  - If there are fewer than 29 ≥ 10-inch trees per acre, leave the 29 largest trees.
  - If there are more than 29 ≥ 10-inch trees per acre, leave 29 ≥ 10-inch dbh trees per acre based on the following priority order:
    - Trees that provide shade to water;
    - Trees that lean towards the water;
    - Trees of the preferred species as defined in WAC 222-16-010;
    - Trees that are evenly distributed across the inner zone.

If more than 50 trees per acre are needed to meet the minimum leave tree basal area for the applicable site index, then additional trees ≥ 6 inches dbh must be left. If the minimum basal area cannot be met with fewer than 100 trees that are ≥ 6 inches dbh, then no more than 100 trees per acre of the largest remaining trees are required to be left regardless of basal area.

**2. Stands with low basal area and high density.**

Basal area and density requirements. Thinning is permitted if the basal area of all species in the inner zone is less than the minimum requirements for the site index (as shown below) AND there are more than 120 trees per acre:

- 70 sq. ft./ac. on low site index (< 90)
- 90 sq. ft./ac. on medium site index (90 to ≤ 110)
- 110 sq. ft./ac. on high site index (> 110)

Leave tree requirements. Thinning in low basal area and high density stands must leave a minimum of 120 trees per acre. The trees to be left shall be selected as follows:

- The 50 largest trees per acre; and
- An additional 70 trees per acre in the 6-inch diameter class or larger. If there are not 70 trees per acre in the 6-inch diameter class or larger, then all trees in the 6-inch diameter class or larger per acre must be left, plus the largest remaining trees to equal 70 trees per acre. Select the additional 70 trees per acre based on the following priority order:
  - Trees that provide shade to water;
  - Trees that lean towards the water;
  - Trees of the preferred species as defined in WAC 222-16-010;
  - Trees that are evenly distributed across the inner zone.

### **Additional Leave Tree Requirements.**

The 21 largest trees do not have to be evenly spaced.

The 29 additional ≥ 10-inch dbh trees per acre should be selected based on the following priority order:

- Trees that provide shade to water.
- Trees that lean toward the water.
- Trees of the preferred species:
  - Ponderosa pine habitat type All hardwoods, Ponderosa pine, western larch, Douglas-fir, western red cedar
  - Mixed conifer habitat type All hardwoods, western larch, Ponderosa pine, western red cedar, western white pine, Douglas-fir, lodgepole pine
- Trees that are evenly spaced across the inner zone.

### **Section 3. Leave tree calculations.**

This is a worksheet for calculating leave trees on **stands with high basal area**. It will help to determine your 21 largest leave trees per acre, the additional 29 leave trees per acre, and the basal areas of those leave trees.

To determine how many of the largest trees are you are required to leave in the inner zone, multiply 21 by inner zone acres.

21 trees X \_\_\_\_\_ acres = \_\_\_\_\_ trees

Calculate the basal area per acre of the **21 largest leave trees per acre**:

- Transfer the information you collected in Section 1 Table 1 to Table 3.1 below, starting with the largest trees and proceeding in descending order until you reach the number of the largest trees you calculated above.

<b>Table 3.1</b> <b>21 Largest Leave Trees Per Acre</b>			
A	B	C	D
<b>Diameter class</b> diameter measured at breast height (dbh)	<b>Basal area per tree</b> (square feet)	<b>Number of trees in the inner zone</b>	<b>Basal area per dbh class</b> (square feet) (multiply numbers in columns B and C)

- Total the numbers in column D. \_\_\_\_\_ sq. ft. total basal area.
- Divide the total basal area by inner zone acres.  
 \_\_\_\_\_ sq. ft. ÷ \_\_\_\_\_ acres = \_\_\_\_\_ sq. ft. basal area per acre (BA/ac.).

Next, determine the **29 additional leave trees per acre** you are required to leave in the inner zone that are ≥ 10 inches dbh: Multiply 29 by inner zone acres.

29 trees X \_\_\_\_\_ acres = \_\_\_\_\_ trees

Calculate the basal area per acre of the **additional 29 leave trees per acre**.

- Transfer information you collected in Section 1 Table 1 to Table 3.2 below, starting with the 10-inch dbh class and proceeding in ascending order until you reach the number of additional trees you calculated above.

If there are fewer than 29 trees per acre ≥ 10 inches dbh in your stand, include the 29 next largest additional trees in this calculation.

<b>Table 3.2</b> <b>Additional 29 Leave Trees Per Acre</b>			
A	B	C	D
<b>Diameter class</b> diameter measured at breast height (dbh)	<b>Basal area per tree</b> (square feet)	<b>Number of trees in the inner zone</b>	<b>Basal area per dbh class</b> (square feet) (multiply numbers in columns B and C)

- Total the numbers in column D. \_\_\_\_\_ sq. ft. total basal area.
- Divide the total basal area by inner zone acres.  
\_\_\_\_\_ sq. ft. ÷ \_\_\_\_\_ acres = \_\_\_\_\_ sq. ft. basal area per acre (BA/ac.).

**Now calculate the total basal area per acre of all leave trees.**

BA/ac. of largest trees \_\_\_\_\_ + BA/ac. of additional trees \_\_\_\_\_ = \_\_\_\_\_ total sq. ft. BA/ac.

**Compare this total with the basal area requirement for your stand habitat type.** If more than 50 trees per acre are needed to meet the minimum leave tree basal area for the applicable site index, then additional trees  $\geq 6$  inches dbh must be left. If the minimum basal area cannot be met with fewer than 100 trees that are  $\geq 6$  inches dbh, then no more than 100 trees per acre of the largest remaining trees are required to left regardless of basal area.

**Section 4. EXAMPLE for a 2-acre inner zone in the Ponderosa pine timber habitat type.**

<b>Table 1</b> <b>Inner Zone Assessment</b> Collect tree data for trees in each 2-inch diameter class, no smaller than the 6-inch diameter class.			
A	B	C	D
Diameter class diameter measured at breast height (dbh)	Basal area per tree (square feet)	Number of trees in the inner zone	Basal area per dbh class (square feet) (multiply numbers in columns B and C)
32 (31 - 32.9 inches)	5.6		
30 (29 - 30.9 inches)	4.9		
28 (27 - 28.9 inches)	4.3		
26 (25 - 26.9 inches)	3.7	8	29.6
24 (23 - 24.9 inches)	3.1	8	24.8
22 (21 - 22.9 inches)	2.6	10	26
20 (19 - 20.9 inches)	2.2	20	44
18 (17 - 18.9 inches)	1.8	20	36
16 (15 - 16.9 inches)	1.4	15	21
14 (13 - 14.9 inches)	1.1	30	33
12 (11 - 12.9 inches)	0.79	40	31.6
10 (9 - 10.9 inches)	0.55	40	22
8 (7 - 8.9 inches)	0.35	50	17.5
6 (5 - 6.9 inches)	0.20	60	12

**Calculate the basal area per acre (BA/ac.) in the inner zone.**

Add the basal areas in column D for a total basal area in the inner zone: 297.5 sq. ft.

Divide the total basal area by the acres in the inner zone:  $\frac{297.5 \text{ sq. ft.}}{2 \text{ acres}} = 148.8 \text{ sq. ft. BA/ac.}$

**Calculate trees per acre in the inner zone.**

Add the number of trees in column C: 301 total trees

Divide the total trees by acres in the inner zone:  $\frac{301 \text{ trees}}{2 \text{ acres}} = 150.5 \text{ trees per acre}$

In this example, harvest is allowed in the inner zone because the basal area per acre in this 2-acre inner zone exceeds the requirement of 110 sq. ft. per acre for the Ponderosa pine timber habitat type. It is also evident that the number of trees per acre in the stand exceeds the minimum leave tree requirement of 50 trees per acre. Now the leave trees will be identified.

Determine the number of largest trees to be left:  $21 \text{ trees} \times 2 \text{ acres} = 42 \text{ trees}$

A	B	C	D
<b>Diameter class</b> diameter measured at breast height (dbh)	<b>Basal area per tree (square feet)</b>	<b>Number of trees in the inner zone</b>	<b>Basal area per dbh class (square feet)</b> (multiply numbers in columns B and C)
26	3.7	8	29.6
24	3.1	8	24.8
22	2.6	10	26.0
20	2.2	16	35.2

Total the numbers in column D. 115.6 sq. ft. basal area

Divide the total basal area by inner zone acres:  $\frac{115.6 \text{ sq. ft.}}{2 \text{ acres}} = 57.8 \text{ sq. ft. BA/ac.}$

Calculate the number of additional trees  $\geq 10$  inches dbh to be left:  $29 \text{ trees} \times 2 \text{ acres} = 58 \text{ trees}$

A	B	C	D
<b>Diameter class</b> diameter measured at breast height (dbh)	<b>Basal area per tree (square feet)</b>	<b>Number of trees in the inner zone</b>	<b>Basal area per dbh class (square feet)</b> (multiply numbers in columns B and C)
10	.55	40	22.0
12	.79	18	14.2

Total the numbers in column D. 36.2 sq. ft. basal area

Divide the total basal area by inner zone acres: 36.2 sq. ft. ÷ 2 acres = 18.2 sq. ft. BA/ac.

**Total the basal area per acre of the 21 largest trees per acre plus the 29 additional leaf trees per acre:** BA/ac. of 21 largest trees per acre 57.8 + BA/ac. of additional 29 trees per acre 18.2 = 76 sq. ft. total BA/ac.

In this example, the total basal area per acre of the 50 required leaf trees per acre is 76 sq. ft. This meets the leaf tree requirement for a stand with high basal area in the Ponderosa pine timber habitat type.

## Section 8

# Guidelines for Wetland Delineation

<b>PART 1. INTRODUCTION</b> .....	<b>1</b>
Wetland Definition .....	1
Approaches .....	2
<b>PART 2. TECHNICAL CRITERIA THAT IDENTIFY WETLANDS</b> .....	<b>2</b>
<b>PART 3. FIELD INDICATORS USED TO SATISFY THE TECHNICAL CRITERIA</b> ....	<b>4</b>
Wetland Hydrology .....	5
Hydric Soils .....	5
Hydrophytic Vegetation .....	6
<b>PART 4. METHODS FOR IDENTIFICATION OF WETLANDS AND DELINEATION OF THEIR BOUNDARIES</b> .....	<b>6</b>
Approximate Determination of Wetland Boundaries .....	7
Accurate Delineation of Wetland Boundaries .....	8
<b>PART 5. BOG IDENTIFICATION</b> .....	<b>9</b>
Characteristic bog species in Washington State .....	12
Appendix A Criteria for Vegetation, Soils, and Hydrology .....	14
Appendix B Method For Disturbed Areas .....	17
Appendix C Problem Area Wetlands .....	19
<b>REFERENCES</b> .....	<b>21</b>
<b>GLOSSARY</b> .....	<b>22</b>

### PART 1. INTRODUCTION

The purpose of this section of the manual is to provide guidance in identifying wetlands and delineating their boundaries with non-wetlands for implementation of the Washington Forest Practice Rules. *This manual is intended to be used only for forest practices.*

#### **Wetland Definition**

For the purposes of the Forest Practice Rules, “wetland” means those areas that are inundated or saturated by surface or groundwater at a frequency and duration sufficient to support, and under normal circumstances do support, a prevalence of vegetation typically adapted for life in saturated soil conditions, such as swamps, bogs, fens, and similar areas. This includes wetlands created, restored, or enhanced as part of a mitigation procedure. This does not include constructed wetlands or the following surface waters of the state intentionally constructed from wetland sites: Irrigation and drainage ditches, grass lined swales, canals, agricultural detention facilities, farm ponds, and landscape amenities.”

Explicit in this definition is the consideration of three environmental parameters: hydrology, soil, and vegetation. Observable evidence of all three parameters normally is present in wetlands.

As referred to in the definition of wetlands, “constructed wetlands” means those wetlands voluntarily developed by the landowner. Constructed wetlands do not include wetlands created, restored, or enhanced as part of a mitigation procedure or wetlands inadvertently created as a result of current or past practices including but not limited to: road construction, landing construction, railroad construction or surface mining.

### **Approaches**

Two approaches are provided in **Part 4** for identifying and delineating wetlands depending on the complexity of the site in question and on the availability, quality, and quantity of existing data:

**Approximate Determination of Wetland Boundaries** is used for delineating:

- forested wetlands greater than 3 acres within a harvest area
- classifying the type of wetland which is within or adjacent to the proposal
- determination of acres of Type A and B wetlands
- Forested wetlands in association with an RMZ
- Approximate determination uses maps, aerial photographs, and other information if adequate data of this nature exists. Not all wetlands are visible on aerial photos or can be located using existing map products. Field visits may be necessary.

**Accurate Delineation of Wetland Boundaries** is used to determine those portions of any wetland where road construction that could result in filling or draining more than 0.1 acre.

This approach requires actually visiting the site and provides a basic method for identifying the presence of wetlands and delineating their boundaries. The same basic method is reiterated as needed as the size or complexity of the site in question increases.

**Either approach may be used** when determining the innermost boundary of WMZ of Type A and B wetlands. The innermost boundary of a WMZ for Type A and B wetlands can also be determined by locating the point on the wetland edge where the crown cover changes from less than 30% to greater than 30%. This is generally the drip line of the conifer trees at the edge of the wetland.

When the presence of a bog is suspected, Part 5 of this section, Bog Identification, should be consulted. The practitioner may want to request assistance from Department of Natural Resources (DNR) or Department of Ecology (DOE) wetlands specialists to verify bog identification. Occasionally, the practitioner may encounter a disturbed Area wetland defined as an area in which one or more of the parameters (vegetation, soil, and/or hydrology) have been sufficiently altered by recent human activities or natural events to preclude the presence of wetland indicators of the parameter. Likewise, the practitioner may encounter one of whose certain wetland type and/or conditions termed Problem Area wetlands in which finding or interpreting indicators of one of more parameters is difficult. In either of these situations, it is suggested that the practitioner request assistance from DNR or DOE wetland specialists to complete delineation.

## **PART 2. TECHNICAL CRITERIA THAT IDENTIFY WETLANDS**

Areas are determined to be wetlands if they satisfy (directly or indirectly) the minimum criteria standards for each of three parameters (hydrology, soils, *and* vegetation). “Criteria” are observations that in and of themselves are sufficiently conclusive to satisfy that a parameter is indicative of a wetland rather than non-wetland condition. The criteria are described specifically in Appendix A. If any one of the features described in Appendix A can be observed for each of all three parameters, it is mandatory that the site be called a wetland. In many cases, it will not be possible to observe features on a site that *directly* satisfy the criteria. However, other observable features - known as “field indicators” - may be used, and like circumstantial evidence, may make the case for wetland *indirectly*. Such interpretation of circumstantial evidence, or field indicators, is allowed within bounds of good professional judgment. Field indicators are discussed in Part 3.



Although vegetation is the most easily observed parameter, sole reliance on vegetation as the determinant of wetlands can be misleading. Many plant species tolerate a broad range of conditions enabling them to live successfully in both wetlands and non-wetlands, and hydrophytic vegetation may persist for decades following alteration of hydrology that renders a site a non-wetland. The criteria for hydrophytic vegetation is as follows:

**If, under normal circumstances, more than 50 percent of the dominant species totaled from all vegetation strata are Obligate Wetland (OBL) Facultative Wetland (FACW) or Facultative (FAC).**

Likewise, soils can be strong indicators of whether or not a site is a wetland when it is in an undrained landscape or in a hydrologically unaltered condition. While soils are excellent long-term integrators of all the ecological influences on a site including relative wetness, on hydrologically altered sites, they generally retain the morphological characteristics revealing their origin (i.e. having developed over geologic time in a wetland or in a non-wetland) long after site hydrology has been totally reversed.

The criteria for **hydric soils** is as follows:

**Unless drained or protected from inundation:**

1. All Histosols (peats and mucks) except Folists or;
2. Soils in Aquic suborder, Aquic subgroups, Allbolls suborder, Salorthids great group, Pell great groups of Vertisols, Pachic subgroups, or Cumulic subgroups that are:
  - a. "Somewhat poorly drained" and have a frequently occurring water table at less than 0.5 foot (ft.) from the surface for a significant period (usually more than 2 weeks) during the growing season or;
  - b. "Poorly" or "Very Poorly" drained and have either:
    - i. a frequently occurring water table at less than 0.5 ft. from the surface for a significant period (usually more than 2 weeks) during the growing season if textures are coarse sand, sand, or fine sand in all layers within 20 inches (in.) Or; for other soils;
    - ii. a frequently occurring water table at less than 1.0 ft. from the surface for a significant period (usually more than 2 weeks) during the growing season if permeability is equal to or greater than 6.0 in./hour (hr.) in all layers within 20 inches (in.) Or;
    - iii. a frequently occurring water table at less than 1.5 ft. from the surface for a significant period (usually more than 2 weeks) during the growing season if permeability is less than 6.0 in./hr. in any layer within 20 in. or;
3. Soils that are frequently ponded for "long duration" or "very long duration" during the growing season or;
4. Soils that are frequently flooded for "long duration" or "very long duration" during the growing season.

On the other hand, if enough data exists, determination of whether or not a site is a wetland could be made based on hydrology alone irrespective of vegetation or soils.

The criteria for **wetland hydrology** is as follows:

The area is inundated either permanently or periodically to a depth at which emergent vegetation interfaces with open water, or the soil has a frequently occurring high water table that remains within 12 inches of the surface for more than 14 consecutive days during the growing season of the prevalent vegetation.

In the vast majority of circumstances, however, adequate data to make a decision based on hydrology alone almost never occurs. Further, direct evidence of the relative degree of site wetness may be ephemeral. What can be done is a direct assessment of site physical and geomorphic characteristics adequate to indicate whether or not site hydrology is likely to have been altered substantively either by human or natural causes. (Substantive alteration means that the site has become either wetter or drier than it had been during the periods over which both its plant community and soils developed.) If such an assessment indicates no substantive removal of site hydrology, and both vegetation and soils, indicate wetland conditions, the site should be determined a wetland.

The combined use of evidence for all three parameters (hydrology, soils, and vegetation) will enhance the technical accuracy, consistency, and credibility of wetland determinations.

Generally, in Washington's forested regions, the determination of whether or not a site is a wetland can be based on observation of criteria and/or field indicators. Part 3 shows a simplified approach for identifying wetlands. Part 5 identifies bogs and low-nutrient fens. Special considerations necessary for identifying and delineating Disturbed and Problem Areas are outlined in Appendices B and C respectively.

NOTE: In interpreting the results of a wetland determination, conclusions based on the observation of criteria features (as listed in Appendix A) supersede those based on the observation of field indicators (as described in Part 3). Before an area is designated as a wetland, a reasonable hypothesis explaining the source of water for this specific site should be determined. The hypothesis should take into account the effectiveness of any possible drainage that has occurred. Further, the hypothesis should make more sense based on available observations than would the alternative hypothesis (i.e. that the same observations lead to the conclusion that wetland hydrology is not present). The water which enables a site to be a wetland is usually the result of one or combination of the following sources: 1) flooding (headwater, backwater, and/or tidal); 2) precipitation (including snowmelt) and runoff (resulting in ponding and/or perched water tables); and/or, 3) groundwater, in the form of seasonal high water tables (apparent and/or artesian).

### **PART 3. FIELD INDICATORS USED TO SATISFY THE TECHNICAL CRITERIA**

Wetlands are identified and delineated based on three environmental parameters: hydrology, vegetation, and soil. The presence of one or more of the observations listed in this section are considered positive "field indicators" that indirectly satisfy the wetland criteria for the appropriate parameter. *At least one positive indicator for each of the three parameters must be present in order to determine that a site is a wetland.* The field indicators for each parameter typically used to make wetland determinations are listed in each of the following sections:

### **Wetland Hydrology**

Field Indicators listed in order of descending reliability:

- a. Recorded hydrologic data including stream, lake, or tidal gauge data, flood predictions, and historical flood records;
- b. Aerial photography records showing flooding or ponding;
- c. Visual observation that the site is inundated;
- d. Visual observation of the water table within 12 inches of the soil surface;
- e. Rusty colored mineral staining in channels or halos (Oxidized rhizospheres) surrounding *living* roots or underground stems;
- f. Watermarks;
- g. Drift lines;
- h. Waterborne sediment deposits (including encrusted filamentous algae);
- i. Drainage patterns relative to site geomorphology (e.g. a closed basin with no outlet or with an elevation controlled outlet);
- j. Judgment-tempered observations of undrained condition.\*

\*Wetland systems controlled only by seasonal high groundwater generally lack surface indicators of wetland hydrology such as those listed. However, these systems can be dominated by OBL, FACW, and/or FAC plant species and have undrained hydric soils. In such systems, the delineator may, after considering the seasonal fluctuation pattern in depth to the water table, conclude that the hydrology criterion is satisfied if there is no observable indication that the hydrology has been substantively modified by either man-made (e.g. ditching, tile-draining, diking) or natural processes (e.g. chronic incision by a stream lowering its base level and reducing its ability to flood or saturate adjacent areas). Thus, the inability to observe high water table during the season of the year when it should be at its low point (e.g. summer, early fall) does not suggest that wetland hydrology is absent. Conversely, the inability to observe high water table during the time of year when it should be near the surface (e.g. winter, early spring) suggests that wetland hydrology may not be present. Such interpretations must be done in light of precipitation patterns and groundwater recharge capabilities for the system in question.

### **Hydric Soils**

Field Indicators listed *in order of descending reliability*:

#### **Non-Sandy Soils**

1. The soil is an organic soil (i.e. a Histosol like a peat or a muck);
2. The soil is a mineral soil but it has a peat or muck layer (i.e. a "Histic Epipedon") 8 to 16 inches thick. (Note: Thick surface layers of aerated organic matter, or "duff", do not qualify.);
3. Sulfidic material (evidenced by the odor of rotten eggs) is present in the upper 12 inches of the soil profile;
4. An aquic or peraquic moisture regime is present as evidenced by long term observation of hydrology patterns on or in the surface layers of the soil;
5. Direct observation of reducing conditions in the soil. (Note: This is done by such means as periodically conducting chemical testing for the presence of ferrous iron or measuring the redox potential.);
6. Observation as specified for soils with aquic moisture regimes in Soil Taxonomy (SCS 1975, Soils Survey Staff 1990) of soil profile color (hydromorphic) characteristics in the

horizon(s) immediately below the dark A-horizon (A<sub>1</sub> or A<sub>p</sub>) or within 10 inches of the surface, whichever is nearer, including but not limited to the following:

- a. A gleyed matrix (i.e. a predominance of certain gray, greenish, or bluish color as compared with the Munsell Soil Color (1990) “Color Page for Gley”);
  - b. A matrix chroma of 2 or less in mottled soils or as specified for the given soil taxa in Soil Taxonomy (SCS 1975, Soil Survey Staff 1990);
  - c. A matrix chroma of 1 or less in unmottled soils or as specified for the given soil taxa in Soil Taxonomy (SCS 1975, Soil Survey Staff 1990);
7. The presence of many, large iron or manganese concretions in the surface 6 inches of the soil.

### **Sandy Soils**

1. In sandy soil, there is an organic surface layer 3 or more inches thick;
2. In sandy soil, there is a near surface organic pan (spodic horizon—i.e. that keys out as an Aquod in the most recent version of Soil Taxonomy);
3. In sandy soil, there is streaking or staining in the subsurface by organic matter;
4. Data indicate that the water table is less than 6 inches from the surface for more than 14 consecutive days during the growing season.

NOTE: Colors are determined by comparison in the field with Munsell Soil Color Charts (Munsell Color 1990), which standardize the reporting of color by documenting the major aspects of color, Hue, Value, and Chroma as a three-part code. If in question, the color characteristics used for determining whether or not an observed soil is hydric should be as specified within the most recent revision of Soil Taxonomy (SCS 1975, Soil Survey Staff 1990) for the soil taxa listed in the Hydric Soils Criteria portion of Appendix A.

### **Hydrophytic Vegetation**

Field Indicators listed *in order of descending reliability*:

1. More than 50 percent of the dominant\* plant species all strata are considered wetland plants. That is, they are classified as Obligate Wetland (OBL), Facultative Wetland (FACW), and/or Facultative (FAC);
2. A plant community of any species composition if it occurs in an undrained organic (peat or muck) soil.

\* [For guidance on choosing “dominant” plant species, see Hydrophytic Vegetation Criteria” in Appendix A.]

## **PART 4. METHODS FOR IDENTIFICATION OF WETLANDS AND DELINEATION OF THEIR BOUNDARIES**

There are two primary products of wetland delineation:

1. A map showing the location of wetlands on a site; and
2. Documentation supporting why the boundaries are justified as shown on the map. Sometimes an additional product is needed: the location of the wetland boundary having been marked (by flagging, stakes or other means) in the field.

Prior to making a wetland determination, obtain any available information on the vegetation, soil, and hydrology of the site in question. Potential sources of information include but are not limited to the following:

- Topographic maps
- County Soil Survey Reports
- National Wetland Inventory Maps
- Hydric Soils of Washington
- National Hydric Soils List
- County Hydric Soil Map Unit List
- National Insurance Agency Flood Maps
- Local Wetland Maps
- Land Use and Land Cover Maps
- Aerial Photographs (particularly false color infrared)
- Satellite imagery
- National List of Plant species that Occur in Wetlands
- Regional List of Plants that Occur in Wetlands
- National Wetland Plant Data Base
- Gauge Data (stream, lake, or tidal)
- SCS Soil Drainage Guides
- Environmental Impact Assessments and Statements
- Published Reports
- Agency Experts (i.e. specialists designated within DNR, DOE, etc.)
- Local Expertise (e.g. Universities, consultants and others)
- Site-specific Plans and Engineering Designs (e.g. state projects or developers).
- *Recognizing Wetlands*, Bigley and Hull, DNR FLM Contribution No. 500, January 1993.

Decide whether information for each parameter is sufficient to enable a determination without a site visit.

Three methods for wetland determinations are described in the following pages and in the Appendices:

1. Approximate Determination of Wetland Boundaries (no site visit is conducted);
2. Accurate Delineation of Wetland Boundaries (site visit required); and
3. Methods for Disturbed Areas (an onsite method used when an area has been altered recently to the point that one or more of the parameters cannot be interpreted).

### **Approximate Determination of Wetland Boundaries**

To determine the probability of the presence of a wetland prior to an actual site visit or when no site visit is possible examine all data available. If data are not adequate to evaluate all three parameters, a site visit will be necessary. If one or more of the parameters has been altered to the extent that it cannot be interpreted, it will be necessary to use the section on *Methods for Disturbed Areas* (MDA) listed in Appendix B. Likewise, if the site meets one of the landscape conditions listed in Appendix C, use the guidance in the *Problem Areas* section (Appendix C) in conjunction with the method below to determine if the site is a wetland.

Develop a series of overlay maps at the same scale. Overlay information for each of the following points of observation:

- Soil Survey maps showing map units dominated by soils listed as hydric;
- Soil Survey maps showing map units dominated by soils with hydric inclusions;

- National Wetland Inventory Maps showing wetlands;
- Other maps showing wetlands;
- Aerial photography (particularly color infrared) showing wetness signatures;
- Contour maps showing level to almost level ground adjacent to streams or in valley bottoms;
- Other data demonstrating wetness characteristic as described in Parts 2 and 3 that are capable of being depicted to scale on a map overlay.

Each successive layer of information imparts a degree of confidence that wetlands exist on the site in question. While this approach is crude, the more layers that overlap, the higher the confidence level that wetlands are present. Even one layer of information is adequate to spur closer consideration. *Since the landowner is ultimately responsible for compliance with wetland regulations, great caution should be used in proceeding with work at a location that has not received an onsite investigation.*

#### **Accurate Delineation of Wetland Boundaries**

A site visit is required. When a site visit is possible or necessary, the following approach can be used:

1. Determine if the area has been altered to the extent that vegetation, soils, or hydrology cannot be interpreted. If the site is altered, go to the *Disturbed Area Method* (Appendix B).
2. Determine if the site meets one of the landscape conditions listed in Appendix C; if so, use the guidance in the *Problem Areas* section (Appendix C) in conjunction with the method below to determine if the site is a wetland.
3. If the hydrology, soils, and vegetation on the site all can be interpreted and the site is not one of the types listed as a Problem Area, subdivide the site into units with similar plant communities, topographic features and/or other natural features. In each landscape unit, find a location that is most typical of the entire unit and record observations that confirm the presence or absence of criteria of field indicators for each of the three parameters. Combine this with any other data available for the site, then go to 1 (a), follow the key, and determine if the landscape unit is wetland or nonwetland. Conclusions are indicated in **bold** type as **Wetlands** or **Nonwetlands**.

	Question	Resp	Action
1.	(a) Hydrology not substantially altered (i.e. site is not effectively drained).	Yes No	Go to 1
	(b) Field indicator of wetland hydrology Present	Yes No	Go to <b>MDA</b> Go to 2 (a) <b>Nonwetland</b>
2.	(a) Soils present are peats or mucks (i.e. Histosols).	Yes No	Go to 2 (b) Go to 3 (a)
	(b) Plants (of any kind) are present.	Yes No	<b>Wetland</b> Go to <b>MDA</b>
3.	(a) <b><u>Soil present is undisturbed.</u></b>	Yes No	Go to (b) Go to <b>MDA</b>
	(b) <b><u>Indicator of hydric soil present.</u></b>	Yes No	Go to 4 (a) <b>Nonwetland</b>
4.	(a) Plants are present. (Identify plant community type(s). Delineator must know dominant plant species of each type)	Yes No	Go to 4(b) Go to <b>MDA</b>
	(b) (Identify plant community type(s). Delineator must know dominant plant species of each type.) Dominant plant species > 50 percent OBL, FACW, and/or FAC.	Yes No	<b>Wetland</b> <b>Nonwetland</b>

It is suggested that the delineator assemble the data that enabled the distinction between wetland and nonwetland into a brief report with a statement explaining how the distinction was made and why. Record the position of the wetland boundary on a map or aerial photograph.

## PART 5. BOG IDENTIFICATION

Bogs and nutrient poor fens are distinct wetland types that are very sensitive to disturbance. Bogs and fens form when organic material accumulates in a wetland setting faster than it decomposes. These systems, however, form extremely slowly, with the organic soils forming at approximately one inch in 40 years in Western Washington, and even slower in Eastern Washington. Bogs and nutrient poor fens are generally acidic and low fertility for plants. Plants growing in these sensitive wetlands are specifically adapted to such conditions, and are usually not found, or uncommonly found, elsewhere. Thus, minor changes in the water regime or nutrient levels in bogs may cause major changes in the plant community. Bogs, and their associated acidic peat environment, provide a habitat for many unique and specialized species of plants and animals. It is not currently possible to construct or restore bogs. The environment is too complex and it takes centuries for the peat to accumulate. There are no known examples of successful bog restoration or creation.

Bogs and nutrient poor fens in Washington state can be either open or forested. Open bogs are dominated by short, emergent vegetation that rarely exceeds six feet in height in western

Washington and three feet in eastern Washington. The ground is usually very spongy and covered with Sphagnum moss. Some open bogs will actually be floating on top of a small lake or pond and have open water underneath. Open bogs may contain stunted individual trees of sitka spruce, western red cedar, western hemlock, lodgepole pine, western white pine, aspen, Engelmann's spruce, or crab apple.

Forested bogs are harder to identify. These contain mature, full-sized trees of sitka spruce, western red cedar, western hemlock, lodgepole pine, western white pine, Engelmann's spruce, or aspen. The characteristics which typically identify these forests as bogs are a layer of Sphagnum moss and deep organic soils. Also, the ground often feels spongy and is frequently saturated with water even during the dry season. The Sphagnum may not be easily seen, especially if there are pools of standing water in the forest or it is covered by litter. Forested bogs may also have a ground cover of salal or other upland species growing from hummocks or downed logs giving the area the superficial appearance of an upland forest. One often has to look under the ground cover and in pools of standing water to determine whether Sphagnum is present.

Identifying bogs can be challenging, particularly in a forested setting. It is necessary to confirm the presence of organic soils by digging soil pits and it requires the identification of plant species. It may also be difficult to determine the boundaries of a bog. In many cases, it may be necessary to ask for the assistance of a wetlands specialist. The DNR and DOE have staff available to assist with bog identification. The following key was developed as a guide to help in the identification of bogs.

#### Forest Practices Bog Identification Key

	Question	Resp	Action
1.	Area is dominated by mosses, low grass-like or shrubby vegetation, in 1/4 acre or more.	Yes No	go to 4 go to 2.
2.	Area has a mixture of stunted trees (sitka spruce, western hemlock, western red cedar, lodgepole pine, Engelmann's spruce, western white pine, aspen or crab apple) and low vegetation in 1/4 acre or more.	Yes No	go to 4 go to 3.
3.	Area is forested with sitka spruce, western red cedar, western hemlock, lodgepole pine, quaking aspen, or western white pine, WITH Sphagnum moss as a dominant ground cover (> 30% coverage of the ground) within at least 1/4 acre of the wetland.	Yes No	go to 4. <b>Is not a bog.</b>

NOTE: A 30% cover of Sphagnum in 1/4 acre means that 30% of the ground within an area of 1/4 acre is shaded by Sphagnum if a light were placed directly over the vegetation. The Sphagnum may be found under a cover of other emergent or shrub vegetation, and at the bottom of temporary pools during the wet season.



	Question	Resp	Action
4.	<p>Area has organic soils, either peats or mucks, deeper than 16 inches. Organic soils are defined as follows based on the information in <i>Soil Taxonomy</i> (1992):</p> <p>a. soils with an organic carbon content of 18% or more (excluding live roots) if the mineral fraction contains more than 60% clay;</p> <p>b. soils with an organic carbon content of 12% if the mineral fraction contains no clay;</p> <p>c. soils with an organic carbon content between 12-18% based on the percentage of clay present (multiply the actual percentage of clay by 0.1 and add to 12%).</p>	<p>Yes</p> <p>No</p>	<p>go to 6</p> <p>go to 5</p>

It is not usually necessary, however, to do a chemical analysis of the soil to determine if a soil is organic. Organic soils are easy to recognize as black-colored mucks or as black or dark brown peats. Mucks feel greasy and stain fingers when rubbed between the fingers. Peats have plant fragments visible throughout the soil and feel fibrous. Many organic soils, both peats and mucks, may smell of hydrogen sulfide (rotten eggs).

	Question	Resp	Action
5.	Area has organic soils, either peats or mucks that are less than 16 inches deep over bedrock or hardpan.	<p>Yes</p> <p>No</p>	<p>go to 6</p> <p><b>Is not a bog.</b></p>
6.	More than 30% of the total plant cover is provided by one or more of the species listed in Table 8.1. Total cover is estimated by assessing the area of land covered by the shadow of plants if the sun were directly overhead.	<p>Yes</p> <p>No</p>	<p><b>IS A BOG.</b></p> <p><b>Is not a bog.</b></p>

NOTE: Forests may contain several layers of plants that cover the ground. In arriving at the 30% minimum cover look at plants in the “canopy”, the “understory”, and the “groundcover”. The objective is to try to determine whether the total “footprint” of plants listed in Table 8.1, be they canopy, understory, or groundcover, is more than 30%.

**Table 8.1 Characteristic bog species in Washington State**

<i>Andromeda polifolia</i>	Bog rosemary
<i>Betula glandulosa</i>	Bog birch
<i>Carex brunescens</i>	Brownish sedge
<i>Carex buxbaumii</i>	Brown bog sedge
<i>Carex canescens</i>	Hoary sedge
<i>Carex chordorhiza</i>	Creeping sedge
<i>Carex comosa</i>	Bearded sedge
<i>Carex lasiocarpa</i>	Wolly-fruit sedge
<i>Carex leptalea</i>	Bristly-stalk sedge
<i>Carex limosa</i>	Mud sedge
<i>Carex livida</i>	Livid sedge
<i>Carex paupercula</i>	Poor sedge
<i>Carex rostrata</i>	Beaked sedge
<i>Carex saxatilis</i>	Russet sedge
<i>Carex sitchensis</i>	Sitka sedge
<i>Carex interior</i>	Inland sedge
<i>Carex pauciflora</i>	Few-flower sedge
<i>Cladina rangifera</i>	Reindeer lichen
<i>Drosera rotundifolia</i>	Sundew
<i>Eleocharis pauciflora</i>	Few-flower spike rush
<i>Empetrum nigrum</i>	Black crowberry
<i>Eriophorum chamissonis</i>	Cottongrass
<i>Eriophorum polystachion</i>	Coldswamp cottongrass
<i>Fauria crista-galli</i>	Deer-cabbage
<i>Gentiana douglasiana</i>	Swamp gentian
<i>Juncus supiniformis</i>	Hairy leaf rush
<i>Kalmia occidentalis</i>	Bog laurel
<i>Ledum groenlandicum</i>	Labrador tea
<i>Lysichitum americanum</i>	American skunk cabbage
<i>Malus fusca</i>	Pacific crabapple
<i>Menyanthes trifoliata</i>	Bog bean
<i>Myrica gale</i>	Sweet gale
<i>Pedicularis groenlandica</i>	Elephant's-head lousewort
<i>Picea engelmannii</i>	Engelmann's spruce
<i>Picea sitchensis</i>	Sitka spruce
<i>Pinus contorta</i>	Lodgepole pine
<i>Pinus monticola</i>	Western white pine
<i>Platanthera dilatata</i>	Leafy white orchid
<i>Populus tremula</i>	Quaking aspen
<i>Potentilla palustris</i>	Marsh cinquefoil
<i>Pteridium aquilinum</i>	Bracken fern

Table 8.1 (Continued)

## Characteristic bog species in Washington State

<i>Rhynchospora alba</i>	White beakrush
<i>Salix commutata</i>	Under-green willow
<i>Salix eastwoodiae</i>	Mountain willow
<i>Salix farriae</i>	Farr willow
<i>Salix myrtillifolia</i>	Blue-berry willow
<i>Salix planifolia</i>	Diamond leaf willow
<i>Sanguisorba officinalis</i>	Great burnet
<i>Sphagnum spp.</i>	Sphagnum mosses
<i>Spiranthes romanzofianna</i>	Hooded ladies'-tresses
<i>Thuja plicata</i>	Western red cedar
<i>Tofieldia glutinosa</i>	Sticky false-asphodel
<i>Tsuga heterophylla</i>	Western hemlock
<i>Vaccinium occidentale</i>	Western huckleberry
<i>Vaccinium oxycoccus</i>	Bog cranberry

NOTE: Latin names and spelling are based on the U.S. Fish and Wildlife Service, "National List of Plant Species that Occur in Wetlands: Washington". Biological Report May 1988. NERC-88/18.47.

## Appendix A Criteria for Vegetation, Soils, and Hydrology

### Wetland Hydrology Criteria

Wetland hydrology is the sum total of wetness characteristics in areas that are inundated or have saturated soil conditions for a sufficient duration to support hydrophytic vegetation. The presence of inundated or saturated conditions for more than a minimum (e.g. usually “long” or “very long”) duration typically creates anaerobic conditions that lead to chemical reduction in the soil and affects the types of plants that can grow and the types of soils that develop on a site.

Numerous factors influence hydrology in an area including, precipitation, stratigraphy, topography, soil permeability, and plant cover (e.g. through evapotranspiration). All sites that can truly be called wetland have at least a seasonal abundance of water that occurs with predictable frequency and for at least a minimum duration. If a site does not have one or more sources of water that are at least seasonally active in more years than half on a long-term basis, it cannot be called a wetland. There are only a limited number of possible sources of water from which a wetland can be maintained: runoff from direct precipitation (including snowmelt); flooding (headwater, backwater, or tidal); ground water (apparent, perched, or artesian water tables); or, some combination of these sources.

The criteria for wetland hydrology is as follows:

**\*\*\*The area is inundated either permanently or periodically to a depth at which emergent vegetation interfaces with open water, or the soil has a frequently occurring high water table that remains within 12 inches of the surface for more than 14 consecutive days during the growing season of the prevalent vegetation.\*\*\***

**NOTE:** In most instances, determination that a site is a wetland will be based on the use of “field indicators” of hydrology (Part 3) rather than meeting the wetland hydrology “criteria” directly. For the purposes of this manual, observation of a field indicators of hydrology will infer that the criteria requirements for frequency, duration, and season are met. In the case of a dispute, direct measurements and observations can be taken to determine if the wetland hydrology criteria are met and such observations will take precedence over field indicators. However, it is not the intent of this manual to require direct observation of hydrology and measurements of its duration in order to correctly identify wetlands and determine their boundaries.

### Hydrophytic Vegetation Criteria

For the purposes of this manual, hydrophytic vegetation is defined as macrophytic plant life growing in water, soil, or on a substrate that is at least periodically deficient in oxygen as a result of excessive water content. Probability of a plant species occurring in a wetland will be determined as specified in the “National List of Plant Species that Occur in Wetlands” (Reed 1988) or its most recent revision as revisions become available. Water tolerance of plants differs from species to species. Based on probability of occurrence in a wetland, this list categorizes plant species with an “indicator status” placing it into one of five basic groups as shown below.

Indicator Status	Symbol	Definition	Estimated Probability of Occurrence in Wetlands
Obligate Wetland Plants	OBL	Plants that under natural conditions almost always occur in wetlands	>99%
Facultative Wetland Plants	FACW	Plants that usually occur in wetlands but occasionally are found in nonwetlands	67-99%
Facultative Plants	FAC	Plants that are equally likely to occur in wetlands or nonwetlands	34-66%
Facultative Upland Plants	FACU	Plants that usually occur in nonwetlands but occasionally are found in wetlands	1-33%
Obligate Upland Plants	UPL	Plants that under natural conditions almost always occur in a nonwetland	<1%

The criteria for hydrophytic vegetation is as follows

**\*\*\*If, under normal circumstances, more than 50 percent of the dominant species totaled from all vegetation strata are OBL, FACW, or FAC.\*\*\***

For each stratum (e.g. tree, shrub/sapling, herb) in the plant community, dominant species will include the most abundant plant species (when ranked in descending order of abundance and cumulatively totaled) that immediately exceed 50 percent of the total dominance measure (e.g. basal area or aerial coverage for that stratum) plus any additional species comprising 20 percent or more of the total dominance measure for the stratum. (Note: if available, importance values will supersede dominance figures alone for determining dominant species.) All dominants, regardless of stratum, will be treated equally in making the calculation to determine whether or not the hydrophytic vegetation criterion is satisfied. The same species can be counted more than once if, in fact, it occurs as a dominant in more than one stratum.

For the purposes of this manual, dominance for all vegetative strata is estimated or sampled in plots at essentially the same elevation in the same soil type encompassing an area no less than 30 feet in radius except for the herbaceous and/or bryophyte strata that for which plots no less than 5 feet in radius are used. The shape and dimension of plots can be altered to fit the field situation so long as the minimum sampling area, equivalent elevation, and similar soil type guidance is followed.

### Hydric Soils Criterion

Hydric soils are defined as “soils that are saturated, flooded, or ponded long enough during the growing season to develop anaerobic conditions in the upper part”. “Soils” are defined as unconsolidated natural material that supports or is capable of supporting plant life. “Ponded” means the site has visible water standing on the surface of the soil in a depression or basin. “Flooded” means the site has visible water on the surface from a flowing source (e.g. overflow from a river). “Saturated” means that all the pore spaces in the soil that can be filled with water are

filled with water. The “growing season” means when the soil in all layers down to 50 cm (19.7 inches) exceeds 5 degrees C (41 degrees F) above which temperature microbial activity in the soil has its greatest effect in intermediating soil processes. In the case of the hydric soil definition, “anaerobic conditions” means not only devoid of adequate oxygen, but infers that oxygen has been lacking for a sufficient period that the soil chemistry is actually a reducing regime rather than an oxidizing regime. “In the upper part” means the water is getting into the controlling portion of the root zone of whatever plants dominate the site. “Long Enough” means that all this is happening for a period of time sufficient to exclude or eliminate long term colonization of the site by plants intolerant of wetness.

**The criteria for hydric soils is as follows.**

**\*\*\*Unless drained or protected from inundation:**

1. All Histosols (peats and mucks) except Folists, or
2. Soils in Aquic suborder, Aquic subgroups, Albolls suborder, Salorthids great group, Pell great groups of Vertisols, Pachic subgroups, or Cumulic subgroups that are:
  - a. “Somewhat poorly drained” and have a frequently occurring water table at less than 0.5 foot (ft) from the surface for a significant period (usually more than 2 weeks) during the growing season, or
  - b. “Poorly” or “Very Poorly” drained and have either:
    - i. a frequently occurring water table at less than 0.5 ft from the surface for a significant period (usually more than 2 weeks) during the growing season if textures are coarse sand, sand, or fine sand in all layers within 20 inches (in), or for other soils
    - ii. a frequently occurring water table at less than 1.0 ft from the surface for a significant period (usually more than 2 weeks) during the growing season if permeability is equal to or greater than 6.0 in/hour (hr) in all layers within 20 inches (in), or
    - iii. a frequently occurring water table at less than 1.5 ft from the surface for a significant period (usually more than 2 weeks) during the growing season if permeability is less than 6.0 in/hr in any layer within 20 in, or
3. Soils that are frequently ponded for “long duration” or “very long duration” during the growing season, or
4. Soils that are frequently flooded for “long duration” or “very long duration” during the growing season.\*\*\*

## Appendix B Method For Disturbed Areas

Apply the following procedures or reasonable modifications of them when evidence indicates human activities or natural events preclude characterization of one or more parameters. These are sites in which assistance from wetland specialists from DNR, DOE, or other sources may be advisable. The point of this section is to assist the delineator in determining whether all three parameters would have been met prior to its alteration making the site a wetland. (NOTE: If the alteration was authorized or if the site would not have been regulated prior to the alteration, this procedure is not necessary.) Record the findings for each parameter as follows and include them in a brief report documenting conclusions for the site. For further guidance, refer to the section on “Disturbed Areas” in the 1989 “Federal Manual for Identifying and Delineating Jurisdictional Wetlands” and the section on “Atypical Situations” in the 1987 “Corps of Engineers Wetland Delineation Manual”. These publications give excellent guidance. However, in making final decisions, the criteria listed in Appendix A of this manual will take precedence.

### 1. **Vegetation.**

- a. Describe the type of alteration (e.g. land clearing, clear cutting, selective removal of certain species).
- b. Document the effect of the alteration on the vegetation.
- c. Characterize the previous vegetation. Obtain all necessary supporting evidence. Some potential sources include:
  - i. Aerial photography
  - ii. Onsite inspection of remaining vegetation
  - iii. Previous site surveys
  - iv. Vegetation in adjacent areas
  - v. Existing records (e.g. ASCS, SCS, FS, etc.)
  - vi. Landowner’s own observations
  - vii. Information from the public
  - viii. National Wetland Inventory maps
- d. Record the indicator status of the dominant plant species.
  - i. If more than 50 percent of the dominant plant species were FAC, FACW, and/or OBL, the previous vegetation was hydrophytic.
  - ii. If condition (1) above is not satisfied, site is NONWETLAND.
  - iii. If the previous vegetation could not be characterized, base the decision on Soil and Hydrology (below).
- e. Record results of vegetation analysis with conclusion. Determine whether or not either the soils or hydrology of the site have been altered.
  - i. If soils and hydrology have not been altered, go to method **for Accurate Delineation of Wetland Boundaries** Step 1 (a) and continue the procedure from that point inserting the conclusions regarding vegetation made here.
  - ii. If either soils or hydrology have been altered, go to “2. Soil”.

### 2. **Soil.**

- a. Describe the alteration (e.g. plowing, filling, surface layers removed).
- b. Document effect on soil.
- c. Characterize previous soils. Obtain all necessary supporting evidence. Some potential sources include:
  - i. Soil surveys.

- ii. Characterization of buried soil profiles.
    - iii. Adjacent unaltered soil. (Reference area must be in the same topographic position and nearby.)
    - iv. Remnant profile where soil layers have been removed.
  - d. Determine whether or not the previous soil was hydric by applying the indicators.
    - i. If a positive indicator is found, hydric soil was formerly present.
    - ii. If no positive indicator is found, **NON-WETLAND**.
    - iii. If previous soil could not be characterized, base decision on Vegetation and Hydrology.
  - e. Record results of soil analysis with conclusion. Determine whether or not the hydrology of the site has been altered.
    - i. If hydrology has not been altered, go to method for **Accurate Delineation of Wetland Boundaries Step 1 (a)** and continue the procedure from that point inserting the conclusions regarding soils made here.
    - ii. If hydrology has been altered, go to “3. Hydrology”.
- 3. **Hydrology.**
  - a. Describe the type of alteration (e.g. site ditched, tiled, levied, diked, etc.).
  - b. Describe the effect of the alteration on hydrology.
  - c. Characterize the previous hydrology. Obtain all necessary supporting evidence. Some potential sources include:
    - i. Stream, lake, or tidal gage data.
    - ii. Remaining field indicators.
    - iii. Aerial photography.
    - iv. Historical records.
    - v. Floodplain management maps.
    - vi. Public official or local observers.
  - d. Determine whether or not wetland hydrology previously occurred by applying the wetland hydrology indicators.
    - i. If a positive indicator is found, wetland hydrology formerly was present.
    - ii. If no indicator is found, **NONWETLAND**.
    - iii. If previous hydrology could not be characterized, base decision on Vegetation and Soil.
  - e. Record results of hydrology analysis with conclusion. Go to method for Accurate Delineation of Wetland Boundaries Step 1 (a) and continue the procedure from that point inserting the conclusions regarding hydrology made here.



## Appendix C Problem Area Wetlands

There are certain types of wetlands and/or conditions that may make wetland identification difficult because field indicators of the three criteria may be absent, at least during certain times of the year. These wetlands are considered problem areas and not disturbed wetlands because the difficulty in identification is due to the peculiarity of their ecology and not the result of human activities or catastrophic natural events, with the exception of newly created wetlands. These are sites in which assistance from wetland specialists from DNR, DOE, or other sources may be advisable. Examples of problem area wetlands encountered in the State of Washington include but are not limited to the following examples:

1. **Evergreen Forested Wetlands.** Wetlands dominated by evergreen trees occur in many parts of the country. In some cases, the trees are OBL, FACW, and FAC species. In other cases, however, the dominant evergreen trees are FACU species such as Western Hemlock (*Tsuga heterophylla*). In dense stands, these trees may preclude establishment of understory vegetation or in some cases, understory vegetation may be FACU species. Since plant communities of these types are usually found in nonwetlands, the ones established in wetland areas may be difficult to recognize at first glance. The landscape position of the evergreen forested areas such as depressions, drainage ways, bottomlands, flats in sloping terrain, and seepage slopes should be considered because it often gives clues to the likelihood of a wetland. If the site is a wetland, there should be clear indications of both hydric soils and wetland hydrology.
2. **Wetlands on Glacial Till.** Sloping wetlands can occur in glaciated areas where thin soils cover relatively impermeable glacial till or where layers of glacial till have different hydraulic conditions that permit groundwater seepage. Such areas are seldom if ever flooded, but downslope groundwater movement keeps the soils saturated for a sufficient portion of the growing season to produce anaerobic and reducing conditions in the soil. This promotes the development of hydric soils and hydrophytic vegetation. Since these are groundwater dominated systems, indicators of wetland hydrology may be lacking during the drier portion of the growing season (e.g. summer or early fall in Washington). Likewise, soil profiles may be difficult to examine in particularly stony tills.
3. **Highly Variable Seasonal Wetlands.** In many regions (especially in arid and semi-arid regions) depressional areas occur that may have indicators of all three wetland criteria during the wetter portions of the growing season (e.g. early spring), but may lack indicators of wetland hydrology (e.g. the ponded surface water all has evaporated) and/or hydrophytic vegetation (e.g. the short lived wetland annuals have completed their life cycle and die) during the drier portion of the growing season. In addition, soil profiles in some of these areas do not have classic wetness characteristic as often observed in most other wetlands. In these systems, OBL and FACW species generally are dominant during the wetter portion of the growing season while FACU and UPL species (also usually annuals) may be dominant during the drier portion of the growing season and during droughts.
4. **Newly Created Wetlands.** These areas include manmade (“created” or “constructed”) wetlands, beaver-created wetlands, and other natural wetlands. Such wetlands may be purposely or accidentally created (e.g. road impoundments, undersized culverts, irrigation, and seepage from earthdammed impoundments) by human activities. Many of these will

have indicators of wetland hydrology and hydrophytic vegetation, but the area may lack typical soil profile characteristics frequently associated with other hydric soils since the soils have only recently been exposed to inundation and/or saturation. Since all of these types of wetlands are newly established, field indicators of one or more of the wetland identification criteria may not be present.

5. **Entisols (including floodplain and sandy soils).** Entisols include a group of soils in a taxonomic order characterized by soils that are young or recently formed and have little or no evidence of pedogenically developed horizons. These soils are typical of floodplains throughout the U.S. (including Washington), but are also found in glacial outwash plains, along tidal waters, and in other areas. They often include sandy soils of riverine islands, bars, and banks, and also finer textured soils of floodplain terraces. Wet entisols that have an aquic or paraquic moisture regime are considered hydric unless effectively drained. Some entisols are easily recognized as hydric soils such as the “Sulfaquents” of tidal marshes, whereas others pose problems because they do not possess profile characteristics typical of many other hydric soils. On a site where entisols are likely to occur, if indicators of hydrophytic vegetation and wetland hydrology are present, confirm whether or not the soil is an entisol. If so, refer to guidance in “Keys to Soil Taxonomy” for guidance in interpreting the soil profile.

## REFERENCES

- Cowardin, L.M., V. Carter, F.C. Golet, and E.T. La Roe.** 1979. Classification of wetlands and deepwater habitats of the United States. U.S. Dept. Interior. Fish and Wildlife Service. FWS/OBS-79/31. 103 pp.
- Environmental Laboratory.** 1987. Corps of Engineers wetlands delineation manual. Tech. Rept. Y-87-1. U.S. Army Engineer Waterways Experiment Station. Vicksburg, Mississippi. 100 pp. + appendices.
- Federal Interagency Committee for Wetland Delineation.** 1989. Federal manual for identifying and delineating jurisdictional wetlands. U.S. Army Corps of Engineers, U.S. Environmental Protection Agency, U.S. Fish and Wildlife Service, and U.S.D.A. Soil Conservation Service. Washington, D.C. Cooperative technical publication. 76 pp. + appendices.
- Munsell Soil Color.** 1990. Munsell soil color charts. Munsell Color, Macbeth A Division of Kollmorgen Corp. Baltimore, Maryland.
- National Technical Committee for Hydric Soils.** 1991. Hydric soils of the United States. U.S.D.A. Soil Conservation Service. Misc. Publ. 1491. Lincoln, Nebraska.
- Reed, P.B., Jr.** 1988. National list of plant species that occur in wetlands: 1988 National Summary. U.S. Dept. Interior. U.S. Fish and Wildlife Service. Biol. Rept. 88(24). 244 pp.
- Soil Survey Staff.** 1975. Soil taxonomy: a basic system of soil classification for making and interpreting soil surveys. U.S.D.A. Soil Conservation Service. Agric. Hdbk. No. 436. Robert E. Kierger Publishing Co., Inc. Melbourne, Florida. 754 pp.
- Soil Survey Staff.** 1990. Keys to soil taxonomy. Agency for International Development and U.S.D.A. Soil Conservation Service. Soil Management Support Staff Tech. Monogr. No. 19, 4th ed. Virginia Poly. Tech. Inst. and State Univ. Blacksburg, Virginia. 422 pp.

## GLOSSARY

**Aerobic:** A condition in which molecular oxygen is a part of the environment.

**Anaerobic:** A condition in which molecular oxygen is absent (or effectively so) from the environment.

**Aquic moisture regime:** A moisture condition associated with a seasonal reducing environment that is virtually free of dissolved oxygen because the soil is saturated by ground water or by water of the capillary fringe, as in soils in Aquic suborders and Aquic subgroups.

**Areal cover:** A measure of dominance that defines the degree to which above ground portions of plants cover the ground surface; it is possible for the total areal cover for all strata combined in a community or for single stratum to exceed 100 percent because:

- (1) most plant communities consist of two or more vegetative strata;
- (2) areal cover is estimated by vegetative layer; and
- (3) foliage within a single layer may overlap.

**Basal area:** The cross-sectional area of a tree trunk measured in square inches, square centimeters, etc.; basal area is normally measured at 4.5 feet above ground level and is used as a measure of dominance; the most commonly used tool for measuring basal area is a diameter tape or a D-tape (then convert to basal area).

**Bryophytes:** A major taxonomic group of nonvascular plants comprised of true liverworts, horned liverworts, and mosses.

**Capillary fringe:** A zone immediately above the water table in which water is drawn upward from the water table by capillary action.

**Chemical reduction:** Any process by which one compound or ion acts as an electron donor; in such cases, the valence state of the electron donor is decreased.

**Chroma:** The relative purity or saturation of a color; intensity of distinctive hue as related to grayness; one of the three variables of color.

**Concretion:** A localized concentration of chemical compounds, (e.g. calcium carbonate and iron oxide) in the form of a grain or nodule of varying size, shape, hardness, and color; concretions of significance in hydric soils are usually iron oxides and manganese oxides occurring at or near the soil surface, which have developed under conditions of fluctuating water tables.

**Criteria:** Technical requirements upon which a judgment or decision may be based. (As used in this manual, criteria are observations that in and of themselves are sufficiently conclusive to satisfy that a parameter is indicative of a wetland rather than nonwetland condition.)

**Disturbed condition:** As used herein, this term refers to areas in which indicators of one or more characteristics (vegetation, soil, and/or hydrology) have been sufficiently altered by man's activities or natural events so as to make it more difficult to recognize whether or not the wetland identification criteria are met.

**Dominance:** As used herein, refers to the spatial extent of a species; commonly the most abundant species in each vegetation stratum that, when ranked in descending order of abundance and cumulatively totaled, immediately exceeds 50 percent of the total dominance measure (e.g. areal cover or basal area) for the stratum, plus any additional species comprising 20 percent or more of the total dominance measure for the stratum.

**Dominance measure:** The means or method by which dominance is established, including areal coverage and basal area; the total dominance measure is the sum total of the dominance measure values for all species comprising a given stratum.

**Dominant species:** For each stratum, dominant species are those that, when ranked in descending rank order and cumulatively totaled, immediately exceed 50 percent of the total dominance measure, plus any additional species comprising 20 percent or more of the total dominance measure for the stratum.

**Drift line:** An accumulation of water-carried debris along a contour or at the base of vegetation that provides direct evidence of prior inundation and often indicates the directional flow of flood waters.

**Duff:** The matted, friable, partly decomposed, organic surface layer of forested soils. This term is used to identify a generally firm organic layer on the surface of mineral soils. It consists of fallen plant material that is in the process of decomposition and includes everything from the litter on the surface to underlying pure humus. (It does not refer to peat or muck, which develop under permanent or nearly permanent periods of saturated soil conditions.)

**Duration (of inundation or soil saturation):** The length of time that water stands above the soil surface (inundation), or that water fills most soil pores near the soil surface; as used herein, “duration” refers to a period during the growing season.

**Effectively drained:** A condition in which surface and/or groundwater has been removed sufficiently by human-induced or natural causes such that an area no longer meets the wetland hydrology criterion. (Note: this condition does not require the total removal of water.)

**Facultative species:** Species that can occur both in wetlands and uplands; there are three subcategories of facultative species: (1) *facultative wetland plants* (FACW) that usually occur in wetlands (estimated probability 67-99%), but occasionally are found in nonwetlands, (2) *facultative plants* (FAC) that are equally likely to occur in wetlands or nonwetlands (estimated probability 34-66%), and (3) *facultative upland plants* (FACU) that usually occur in nonwetlands (estimated probability 67-99%), but occasionally are found in wetlands (estimated probability 1-33%).

**Field Indicators:** Observable features that infer the criteria are met. (For the purposes of this manual, these are non-“criteria” observations that, in the same manner as circumstantial evidence, make the case for wetland indirectly rather than directly.)

**Flooded:** A condition in which the soil surface is temporarily covered with flowing water from any source, such as streams overflowing their banks, runoff from adjacent or surrounding slopes, inflow from high tides, or any combination of sources.

**Flooding, frequent:** Flooding is likely to occur often during usual weather conditions (i.e. more than a 50 percent chance of flooding in any year, or more than 50 times in 100 years).

**Frequency (of inundation or soil saturation):** The periodicity of coverage of an area by surface water or saturation of the soil; it is usually expressed as the number of years the soil is inundated or saturated during part of the growing season of the prevalent vegetation (e.g. 50 years per 100 years) or as a 1-, 2-, 5-year, etc., inundation frequency.

**Gleization:** A process in saturated or nearly saturated soils, which involves the reduction of iron, its segregation into mottles and concretions, or its removal by leaching from the gleyed horizon.

**Gleyed:** A soil condition resulting from gleization which is manifested by the presence of neutral gray, bluish or greenish colors through the soil matrix or in mottles (spots or streaks) among other colors.

**Growing season:** The portion of the year when soil temperatures are above biologic zero (41° F) as defined by Soil Taxonomy; the following growing season months are assumed for each of the soil temperature regimes:

- (1) thermic (February-October);
- (2) mesic (March-October);
- (3) frigid (May-September);
- (4) cryic (June-August);
- (5) pergelic (July-August);
- (6) isohyperthermic (January-December);
- (7) hyperthermic (February-December);
- (8) isothermic (January-December) and
- (9) isomesic (January-December).

**Herb:** Nonwoody (herbaceous) plants including graminoids (grass and grasslike plants), forbs, ferns, fern allies, and nonwoody vines; for the purposes of this manual, seedlings of woody plants less than 3 feet in height are also considered herbs.

**Histic epipedon:** An 8- to 16- inch thick soil layer at or near the surface that is saturated for 30 consecutive days or more during the growing season in most years and contains a minimum of 20 percent organic matter when no clay is present or a minimum of 30 percent of organic matter when 60 percent or more clay is present; generally a thin horizon of peat or muck if the soil has not been plowed.

**Histosols:** An order in “Soil Taxonomy” (Soil Survey Staff 1975) composed of organic soils (mucks and peats) that have organic soil materials in more than half of the upper 32 inches or that are of any thickness if overlying rock.

**Hue:** A characteristic of color related to one of the main spectral colors (red, yellow, green, blue, or purple), or various combinations of these principle colors; one of the three variables of color; each color chart in the Munsell Soil Color Charts (Munsell Soil Color 1990) represents a specific hue.

**Hydric soil:** A soil that is saturated, flooded, or ponded long enough during the growing season to develop anaerobic conditions in the upper part.

**Hydrology:** The science dealing with the properties, distribution, and circulation of water.

**Hydrophyte:** Any macrophyte that grows in water or on a substrate that is at least periodically deficient in oxygen as a result of excessive water content; plants typically found in wetlands and other aquatic habitats.

**Hydrophytic vegetation:** Plant life growing in water or on a substrate that is at least periodically deficient in oxygen as a result of excessive water content.

**Inclusion:** Regarding soil survey report maps, refers to a recognizable, substantive variation from the norm in a mapping unit that due to the scale or detail of the map produced, is not shown on the map itself. Such a substantive variation from the norm is described verbally in the map unit description within the soil survey report as a caution to map users.

**Indicator:** An event, entity, or condition that typically characterizes a prescribed environment or situation; indicators determine or aid in determining whether or not certain stated circumstances exist or criteria are satisfied.

**Inundation:** A condition in which water temporarily or permanently covers a land surface.

**Long duration (flooding):** A duration class in which inundation for a single event ranges from 7 days to 1 month.

**Macrophyte:** Any plant species that can be readily observed without the aid of optical magnification, including all vascular plant species and bryophytes (e.g. Sphagnum spp.), as well as large algae (e.g. Chara spp., and Fucus spp.).

**Matrix:** The natural soil material composed of both mineral and organic matter; matrix color refers to the predominant color of the soil in a particular horizon.

**Microbial:** Pertaining to work by microorganisms too small to be seen with the naked eye.

**Mineral soil:** Any soil consisting primarily of mineral (sand, silt, and clay) material, rather than organic matter.

**Mottles:** Spots or blotches of different color or shades of color interspersed within the dominant matrix color in a soil layer; distinct mottles are readily seen and easily distinguished from the color of the matrix; prominent mottles are obvious and mottling is one of the outstanding features of the horizon.

**Nonhydric soil:** A soil that has developed under predominantly aerobic soil conditions.

**Nonwetland:** Any area that has sufficiently dry conditions that hydrophytic vegetation, hydric soils, and/or wetland hydrology are lacking; it includes upland as well as former wetlands that are effectively drained.

**Normal circumstances:** Refers to the soil and hydrology conditions that are normally present, without regard to whether the vegetation has been removed.

**Obligate wetland species:** A plant species that is nearly always found in wetlands; its frequency of occurrence in wetlands is 99% or more.

**Organic soil:** See Histosols.

**Oxidation-reduction process:** A complex of biochemical reactions in soil that influences the valence state of elements and their ions found in the soil; long periods of soil saturation during the growing season tend to elicit anaerobic conditions that shift the overall process to a reducing condition.

**Oxidized rhizospheres:** Oxidized channels and soil surrounding living roots and rhizomes in plants.

**Parameter:** A characteristic component of a unit that can be defined. (For purposes of this manual, hydrology, soils, and vegetation are the three parameters used to define wetlands.)

**Peraquic moisture regime:** A soil condition in which reducing conditions always occur due to the presence of ground water at or near the soil surface.

**Periodically:** Used herein, to define detectable regular or irregular saturated soil conditions or inundation, resulting from ponding of ground water, precipitation, overland flow, stream flooding, or tidal influences that occur(s) with hours, days, weeks, months, or even years between events.

**Permanently flooded:** A water regime condition where standing water covers the land surface throughout the year (but may be absent during extreme droughts).

**Permeability:** The quality of the soil that enables water to move downward through the profile, measured as the number of inches per hour that water moves downward through the saturated soil.

**Plant community:** The plant populations existing in a shared habitat or environment.

**Ponded:** A condition in which free water covers the soil surface, for example, in a closed depression; the water is removed only by percolation, evaporation, or transpiration.

**Poorly drained:** A condition in which water is removed from the soil so slowly that the soil is saturated periodically during the growing season or remains wet for long periods greater than 7 days.

**Problem area wetland:** A wetland that is difficult to identify because it may lack indicators of wetland hydrology and/or hydric soils, or its dominant plant species are more common of nonwetlands.

**Reduction:** The process of changing an element from a higher to a lower oxidation state as in the reduction of ferric (Fe<sup>3+</sup>) iron into ferrous iron (Fe<sup>2+</sup>).



**Rhizosphere:** The zone of soil in which interactions between living plant roots and microorganisms occur.

**Sapling:** Woody vegetation  $\geq 0.4$  to  $< 5.0$  inches in diameter at breast height and  $\leq 20$  feet in height, exclusive of woody vines.

**Saturated:** A condition in which all easily drained voids (pores) between soil particles are temporarily or permanently filled with water; significant saturation during the growing season is considered to be usually one week or more.

**Shrub:** Wood vegetation usually  $> 3$  feet but less than 20 feet tall, including multi-stemmed bushy specimens and small trees and saplings. (Note: Woody seedlings less than 3 feet tall are considered part of the herbaceous stratum.)

**Soil matrix:** The portion of a given soil having the dominant color; in most cases, the matrix will be the portion of the soil having more than 50 percent of the same color.

**Soil permeability:** The ease with which gases, liquids, or plant roots penetrate or pass through a layer of soil.

**Soil pore:** An area within soil occupied by either air or water, resulting from the arrangement of individual soil particles or peds.

**Somewhat poorly drained:** A condition in which water is removed slowly enough that the soil is wet for significant periods during the growing season.

**Spodic horizon:** A subsurface layer of soil characterized by the accumulation of aluminum oxides (with or without iron oxides) and organic matter; a diagnostic horizon for Spodosols.

**Stratigraphy:** A term referring to the origin, composition, distribution, and succession of geologic strata (layers).

**Stratum:** A layer of vegetation used to determine dominant species in a plant community.  
Suborder (soils): Second highest taxonomic level of the current U.S. soil classification system.

**Swamp:** A wetland dominated by trees; a forested wetland.

**Topography:** The configuration of a surface, including its relief and the position of its natural and manmade features.

**Transpiration:** The process in plants by which water is released into the gaseous environment (atmosphere), primarily through stomata.

**Tree:** A woody plant 5 inches or greater in diameter at breast height and 20 feet or more tall.

**Upland:** Any area that does not qualify as a wetland because the associated hydrologic regime is not sufficiently wet to elicit development of vegetation, soils, and/or hydrologic characteristics

associated with wetlands. Such areas occurring in floodplains are more appropriately termed nonwetlands.

**Value (soil color):** The relative lightness or intensity of color; approximately a function of the square root of the total amount of light; one of the three variables of color.

**Vascular (plant):** Possessing a well-developed system of conducting tissue to transport water, mineral salts, and foods within the plant.

**Vegetation:** The sum total of macrophytes that occupy a given area.

**Very long duration (flooding):** A duration class in which inundation for a single event is greater than 1 month.

**Vertisols:** Shrinking and swelling dark clay soils.

**Very poorly drained:** A condition in which water is removed from the soil so slowly that free water remains at or on the surface during most of the growing season.

**Vine (also Liana):** A plant climbing or scrambling on some support, the stem not standing upright of itself. (As used in this manual, defines a vegetation stratum consist only of the woody species greater than 3 feet in length.)

**Watermark:** A line on vegetation or other upright structures that represents the maximum height reached in an inundation vent.

**Water table:** The depth to which the water surface equalizes with air pressure in an unlined borehole; it includes a zone of saturation at least six inches thick and persists in the soil for more than a few weeks.

**Wetlands:** As used herein, areas that under normal circumstances have hydrophytic vegetation, hydric soils, and wetland hydrology.

**Wetland boundary:** The point on the ground at which a shift from wetlands to nonwetlands occurs.

**Wetland determination:** The process by which an area is identified as a wetland or nonwetland.

**Wetland hydrology:** In general terms, permanent or periodic inundation or prolonged soil saturation sufficient to create anaerobic conditions in the soil.

**Wetland indicator status:** The exclusiveness with which a plant species occurs in wetlands; the different indicator categories (i.e., facultative species, and obligate wetland species) are defined elsewhere in this glossary.

# Section 9 Guidelines for Wetland Replacement by Substitution or Enhancement

**PART 1. INTRODUCTION .....1**  
**PART 2. WAC 222-24-015, CONSTRUCTION IN WETLANDS .....1**

The following section is designed to assist landowners to comply with the provisions of **Chapter 222-24 WAC, Road Construction and Maintenance**. Further assistance may be sought from the Department of Natural Resources, the Department of Fish and Wildlife or Department of Ecology. Individuals with wetland expertise from affected tribes should also be considered for consultation.

## **PART 1. INTRODUCTION**

One of the goals of the road maintenance section is to construct and maintain a road system that has minimal impacts on the public resource and no net loss of wetland function across the landscape.

Forest Practice Application for road or landing construction that will cause more than 0.5 acres to be filled of any individual wetland must be classified a Class IV Special. Replacement of the lost wetland function is required by either creation of new wetlands or the enhancement of existing wetlands. Replacement is on a two for one basis of the same type of wetland in the same general location. Providing an equivalent amount of function to replace what has been impacted or lost.

Accurate delineation is required if the proposed road or landing will fill or drain more than 0.1-acre of a Type A, B, or forested wetland. A tenth acre (0.1) is equal to 4,356 square feet or approximately an area 20 feet by 218 feet or 30 feet by 145 feet.

If the planned activity impacts a Type A, B or forested wetland the wetland mitigation sequence in WAC 222-24-015 is followed. A mitigation plan needs to be attached to the application that indicates:

- How the proposal is the least environmentally damaging location
- How the proposal minimizes impacts
- Describes planned restoration
- How the proposal reduces or eliminates impacts over time
- Planned wetland replacement, include documentation of review by the Department of Ecology
- How does the proposal meet the goal of no net loss of wetland function

**PART 2. WAC 222-24-015, CONSTRUCTION IN WETLANDS** states that “all road and landing construction near or within wetlands must be conducted so that selection of choices are made in the following order with avoidance being the most preferred and replacement being the least preferred alternative.”

1. Avoid impacts by selecting the least environmentally damaging landing location, road location and road length. Landowners must attempt to minimize road length concurrently with the attempt to avoid wetlands.
  - Make approximate determination of wetland boundaries of Type A, B and forested wetlands in the vicinity of the proposed road or landing location.
  - Consider the environmental consequences of road length and construction of alternate locations (i.e. stream crossings, stream adjacent parallel roads, unstable slopes).
  - Seek cooperation with adjacent landowners for alternate access.
  - Consider alternate harvest methods to reduce road length and impacts from landings.
  - Consider using temporary roads.
2. Minimize impacts by reducing the subgrade width, fill acreage and spoil areas
  - Reduce running surface width to one lane where practical with a minimum number of turnouts.
  - Minimize length of road crossing wetlands.
  - Landing size should be reduced in wetlands by minimizing log storage on site.
  - All efforts should be made to find non-wetland sites for spoil disposal. If disposal in wetlands is necessary, acreage should be minimized by increase in pile height.
  - Appropriate means should be used to minimize sediment generation and entry to wetlands (i.e. sediment traps, use clean fill and surfacing material, slope road approaches away, merchandise logs away from wetland, limit road use to the driest time of the year).
  - Use construction matting (geo-textile fabrics) along with puncheon, or other method to reduce the impacts of fill.
3. Restore affected areas by removing temporary fills or road sections upon the completion of the project.
  - Road approaches to wetland areas should be stabilized and re-vegetated with native plant species early enough in the season so that vegetation can be established on the site prior to the wet season.
  - Remove the road fill or sections of road fill to at or below the original wetland grade.
4. Reduce or eliminate impacts over time by preserving or maintaining areas
  - Restrict road use in wetlands or abandon roads following harvest.
  - Preserve undisturbed forested wetland areas that would otherwise be harvested under current regulations.
  - Retain additional wildlife trees, beyond the reserve tree requirements, in or adjacent to RMZ's or WMZ's.
  - Evaluate the road network for existing roads that are not critical for future management that are located within wetlands that can be abandoned.
5. Replace affected areas by creating new wetlands or enhancing existing wetlands.
  - Wetland creation is costly, complex and uncertain. All enhancement options should be pursued prior to attempting wetland creation.
  - Enhancement options include importing beavers, raising culverts, creating off-channel fish habitat, providing duck boxes, improving plant diversity or habitat complexity by leaving undisturbed forested wetland areas, or some combination of available options.

- Where enhancement is not feasible, contact the Departments of Ecology or Fish and Wildlife, or a wetlands consultant for creation possibilities. If the area is within the boundary of an Indian reservation contact the tribe.
- Site specific plans for creating wetlands generally will require creation of more acres of wetlands than those filled or drained to ensure establishment of adequate function. Monitoring will be required to ensure success of the creation project.

## Section 10

### Non-Native Wetland Plant Species

The following list is to be used in conjunction with **WAC 222-24-030 (4), Stabilize Soils.**

When selecting seed for cut or fill slope revegetation within or near wetland, avoid seed mixes which contain the following plant genus or species:

<i>Genus or Species</i>	<i>Common Name</i>
<i>Phalaris arundinacea</i>	Reed Canary Grass
<i>Phragmites australis</i>	Reed
<i>Holcus</i> spp.	Velvet Grass
<i>Agrostis</i> spp.	Bent Grass
<i>Vicia</i> spp.	Vetch
<i>Lotus</i> spp.	Trefoil

Preferred seed mixes for revegetation, in or near wetland sites, include such dry upland species, as rye grass or fescue.

## **Section 11 Standard Methodology for Conducting Watershed Analysis**

The *Standard Methodology for Conducting Watershed Analysis*, also known as the Watershed Analysis Manual, is a technical publication required by chapter 222-22 WAC. It is used by qualified scientists and experts to determine, at the watershed administrative unit (WAU) scale, conditions of selected public resources and cultural resources. Forest managers then develop site-specific prescriptions that further regulate forest practices to protect public resources and voluntary management strategies to protect cultural resources. The latest version of the Watershed Analysis Manual is available at [www.dnr.wa.gov/ResearchScience/Topics/WatershedAnalysis/Pages/fp\\_watershed\\_analysis\\_manual.aspx](http://www.dnr.wa.gov/ResearchScience/Topics/WatershedAnalysis/Pages/fp_watershed_analysis_manual.aspx) manual.

Questions regarding the manual should be directed to:  
Department of Natural Resources  
Forest Practices Division  
1111 Washington St. SE  
P.O. Box 47012  
Olympia, WA 98504-7012

Phone: (360) 902-1400  
Fax: (360) 902-1428

## Section 12

### Guidance for Application of Forest Chemicals

<b>PART 1. BEST MANAGEMENT PRACTICES .....</b>	<b>1</b>
<b>PART 2. NOZZLE, EQUIPMENT, AND OPERATIONS .....</b>	<b>1</b>
<b>PART 3. MAINTENANCE OF PESTICIDE RECORDS.....</b>	<b>2</b>

#### **PART 1. BEST MANAGEMENT PRACTICES**

Forest management operations and Christmas tree operations using herbicides should apply the following best management practices (BMPs):

<b>Nozzle Orifice:</b>	Minimum size of D10 (0.156") when core plates are used. Minimum size of D7 (0.109") when no core plates are used.
<b>Core Plate:</b>	Size # 46 or larger.
<b>Nozzle Orientation:</b>	Maximum of 45 degrees downward and backward from the direction of flight.
<b>Operating Pressure:</b>	Not to exceed 30 pounds per square inch.
<b>Boom Length:</b>	Maximum length of 6/7 of rotor span for rotors less than 40 feet, and ? of rotor span for rotors 40 feet or greater.
<b>Airspeed:</b>	Not to exceed 60 miles per hour.
<b>Release Height:</b>	Minimum height consistent with safe operations. Nozzles must be shut off when ascending or descending over an obstacle that would alter the application release height by more than 10 feet, unless buffer-width adjustments have already been made on initiation of the flight line or swaths are adequate distance away from areas needing protection based on release-height buffer specifications in Tables 1 and 2 under <b>WAC 222-38-020(4)(a)(i and ii)</b> .

**Forest management operations and Christmas tree operations using insecticides or fungicides should apply the following best management practices (BMPs)\*:**

<b>Nozzle Orifice:</b>	Minimum size of D8 (0.125") when core plates are used. Minimum size of D4 (0.063") when no core plates are used.
<b>Core Plate:</b>	Size # 46 or larger.
<b>Airspeed:</b>	Not to exceed 60 miles per hour on swaths adjacent to spray buffers.

\*Recommendations on nozzle orientation, operating pressure, boom length, and release height for insecticides and fungicides are the same as those stipulated above for herbicide operations.

#### **PART 2. NOZZLE, EQUIPMENT AND OPERATIONS**

The nozzle size restrictions (nozzle orifice and orientation), equipment limits (boom length), operations restrictions (air speed, weather, and release height), and buffer requirements, in combination, are set to minimize drift off-target. Use of different aerial application equipment which produces an equivalent or lower volume-based percentage of droplets in the less than 150



micron size range or other equipment or operations restrictions which result in less drift off target, will be considered under Alternate Plan provision **WAC 222-12-040**.

**Applicators should apply the following best management practices to weather conditions:**

- Wind Speed:** Do not apply when wind speed exceeds 7 miles per hour.
- Favorable winds:** For purposes of determining the appropriate buffers and offsets described under **WAC 222-38-020(4)(a)(i - iii)**, favorable winds are those where wind direction effectively moves the spray cloud away from the water, RMZ, or WMZ based on visual observation of spray drift (or other commonly used indicators such as smoke) at the site of application.
- Unfavorable winds:** For purposes of determining the appropriate buffers and offsets described under **WAC 222-38-020(4)(a)(i - iii)**, unfavorable winds are any winds, which are not clearly favorable (see above) including calm conditions, inversions, or conditions of highly variable wind conditions.
- Temperature:** Do not apply when ambient air temperature exceeds 70 degrees Fahrenheit for ester formulations or 85 degrees Fahrenheit for other pesticides.
- Relative Humidity:** For Western Washington (**WAC 222-16-010**), do not apply when relative humidity is below 50% for ester formulations or below 40% for other pesticides.
- Precipitation:** If applying pesticides during early foliar or dormant seasons, when precipitation runoff events are most common, avoid direct over-spraying of temporarily dry segments of Type 4 or 5 waters. Do not apply pesticides directly to temporarily dry Type 4 or 5 waters during the 24 hours before a predicted rainfall accumulation event of 1/4" or the 24 hours after an actual accumulation event of more than 1/4".

### **PART 3. MAINTENANCE OF PESTICIDE RECORDS**

Pesticide records should be maintained by the landowner in compliance with **WAC 16-228-190, Applicator Requirements**. The records should also include copies of the approved forest practices applications showing all streams within and adjacent to the application area and indicating which streams were buffered. Direct observation to determine the presence of surface water in Type 4 or 5 waters is recommended, although this is not intended to preclude best professional judgment of the field forester. Direct observation may include walking all streams or a representative sample of the stream segments, checking culverts for flow, provided that the culverts are in a suitable downstream location, and the use of infrared aerial photography. Aerial surveillance is not adequate if the stream segment is obscured by slash or vegetation. Direct observation can be made by a landowner representative, pesticide applicator, or a state agency or tribal representative.

# Section 13

## Guidelines for Determining Fish Use for the Purpose of Typing Waters

**PART 1. INTRODUCTION .....1**

**PART 2. CONSIDERATIONS REQUIRED FOR WATER TYPE CHANGE PROPOSALS .2**

*Stream Features .....2*

*Drought Conditions and Other Factors Affecting Population*

*Distribution .....2*

*Scientific Collection Permits .....3*

*Blockages to Fish Passage .....3*

**PART 3. SURVEY TIMING .....3**

**PART 4. SURVEY EFFORT .....3**

**PART 5. QUALIFIED AND TRAINED STAFF .....4**

**PART 6. ALTERNATIVES FOR MAKING FISH USE DETERMINATIONS .....4**

Until the fish habitat water typing maps are available, as per **WAC 222-16-030**, the following methods are for use with implementing the interim water typing system (**WAC 222-16-031(3) Type 3 Water**) in the forest practices rules.

### PART 1. INTRODUCTION

The rules allow for the opportunity to determine fish use for water typing (**WAC 222-16-031(3)**). The purpose of this section of the Forest Practices Board Manual (manual) is to provide guidelines for making this determination. A uniform stream survey protocol is provided so data may be collected such that affected landowners and other interested parties can provide information necessary to refute the presumption of fish presence (Type 3 Water) or the presumption of fish absence (Type 4 or 5 Water).

Relating to fish use, Type 3 Waters are segments of natural waters that have fish use. At present, a number of fish use waters are not identified on water classification maps or have been misclassified as non-fish use (Type 4 or 5 Water). Likewise, a number of non-fish use waters may be misclassified as having fish use based on physical criteria.

These guidelines are intended to be used only in the following conditions:

1. Verification that DNR mapped breaks between Type 3 Waters and non-fish use waters (Type 4 or 5 Waters) are accurate;
2. Determination whether an unmapped water should be treated as a Type 3 Water, or non-fish use water (Type 4 or 5 Water);
3. Determination that a mapped Type 3 Water can be changed to a non-fish use water (Type 4 or 5 Water);
4. Determination that a mapped non-fish use water (Type 4 or 5 Water) can be changed to a Type 3 Water.

These guidelines cannot be used to determine the break between a Type 4 and 5 Water (see **WAC 222-16-031 (4) and (5)**), or for use on changing the designation of Type 1 or 2 Waters. Data collected using this manual may not be suitable for building or validating the water type model described in **WAC 222-16-030**.

## **PART 2. CONSIDERATIONS REQUIRED FOR WATER TYPE CHANGE PROPOSALS**

### *Stream Features*

The electroshocking protocol in this manual was developed primarily for small width streams (generally streams less than 5 feet bankfull width). Beginning in 2002, landowners who wish to survey for fish in streams larger than 5 feet bankfull width are required to consult with Washington Department of Fish and Wildlife (WDFW) area habitat biologists (as per requirements of WDFW's Scientific Collection Permit) and affected tribes prior to the survey effort. The purpose of the consultation is to preview survey plans with those who will be asked to review the results and cooperatively determine if there are parts of the plans that should be modified to improve the quality of the surveys.

Ponds, spring sources and wetlands are often examples of important non-channel fish habitats that when located in the upper reaches of small streams can provide refuge and rearing areas for anadromous and resident fish populations. Surveyors should attempt to locate such stream features and potential habitats in pre-field reconnaissance of aerial or ortho-photos and local knowledge and insure that these habitats are sampled for fish presence. The presence of fish species at these locations, or in other upstream reaches, is indicative of downstream fish use. Determining fish use in water bodies such as ponds and wetlands can be difficult. Landowners should consult with WDFW area habitat biologists for survey techniques.

### *Drought Conditions and Other Factors Affecting Population Distribution*

Many factors can influence the extent and distribution of fish species in the watershed. Depressed stocks will fail to fill all the available habitat niches. Likewise, drought or flood years may alter how species occupy the habitat or fish access into the habitat. Fish populations may be locally or temporarily extirpated from stream channels due to mass wasting and downstream scouring that can require years before even partial recovery begins. Fish use surveyors must document how such factors if present affect fish distribution in the stream system.

By February 1st of each year, the Washington Department of Natural Resources (DNR), in consultation with the WDFW, will release information forecasting statewide water abundance for the coming fish survey season. This information will be provided to landowners and interested parties who may be conducting fish surveys to allow for appropriate attention to potential drought conditions. If drought conditions exist within the state during the fish survey season, then proponents of a water type change will be required to provide information demonstrating how stream flows and fish use determinations were unaffected by drought conditions. If such information is not provided, or not deemed adequate during the review process, then the proposed water type change will be rejected.

### *Scientific Collection Permits*

Prior to conducting any surveys that may incidentally harm fish, e.g. electroshocking, WDFW regulations require that the landowner or surveyor obtain a current Scientific Collection Permit for stream surveys from WDFW. In addition, an appropriate federal permit is necessary for electrofishing in waters containing bull trout. Resource managers of affected tribes (within their usual and accustomed areas) are not required to apply for a Scientific Collection Permit.

### *Blockages to Fish Passage*

The Forest Practices Rules allow for a stream survey protocol to determine fish use. However, determinations of fish absence using this protocol generally can be applied only to streams where human-made fish blockages, such as impassable culverts, do not exist below the proposed survey reach. The process used to determine absence or presence of blockages to fish passage must be documented. Above human-made fish blockages, physical criteria are used to determine the presumption of fish use unless otherwise approved by the DNR in consultation with the WDFW, Washington Department of Ecology (DOE) and affected tribes.

Natural barriers consisting of waterfalls greater than twelve feet in vertical height or long, steep cascades without fish resting areas generally block upstream migration of anadromous fish. Such features and other potential natural barriers, e.g. beaver dams, present likely sites from which to begin fish use surveys. Resident fish frequently exist upstream of such blockages so the mere presence of a natural barrier is not proof of fish absence.

## **PART 3. SURVEY TIMING**

Survey information collected to determine fish use or the maximum upstream extent of habitat utilization must be collected during the time window when the fish species in question are likely to be present. The spring period through early summer at which time fry are emerged from the gravels and distributing to rearing areas is the most appropriate time. In most cases, this period extends from March 1st to July 15th when water is most likely to be present in the channel. Due to the complexities in anticipating when fish will be seasonally active, survey timing should be determined in consultation with WDFW and affected tribes prior to conducting a survey.

## **PART 4. SURVEY EFFORT**

There are many visual methods such as walking the stream bank and visually observing fish, snorkeling, feeding, and hook and line sampling to show presence at a particular site along a stream segment. Projecting the extent of fish utilization upstream based on observed stream habitat parameters may be as dependent on professional judgment as on measurable physical criteria. Providing evidence that strongly suggests the absence of fish use requires a different methodology than visual observation.

The absence of fish use must be supported by stream survey information collected using a backpack electroshocker to electrofish the stream segment in question. Electroshocking stream survey information may only be collected by qualified or trained staff (see **Part 5. Qualified and Trained Staff**) of state or tribal entities, landowners, consultants or conservation organizations. Injury or mortality to fish can occur from electroshocking and it should be used minimally for this effort.

In special circumstances such as in critical stream reaches of threatened and endangered species such as bull trout and other severely depressed populations, WDFW may reject Scientific

Collection Permits for electroshocking in those streams. In such cases WDFW, landowners and tribal representatives will recommend and approve alternate methods of collecting data for determining fish use. Snorkeling or trapping may be two such examples.

If fish use is not detected using this manual, then survey data submitted must confirm that the survey effort included electroshocking a minimum of 12 of the reaches highest quality pools, three square feet in surface area and one foot residual pool depth or larger. Documentation of stream characteristics is required where the minimum number of pools do not exist in the stream segment. The survey effort shall also cover at least 1/4 mile of stream length upstream from the point of last known fish use unless the stream gradient increases and remains above the 20% gradient threshold and fish are not being found by the survey.

The survey effort for forest practice application specific efforts begins at the down stream end of the unit and continues upstream for the length of the proposed forest practice unit or 1/4 mile, which ever is the greater, to include at least the minimum shocking effort of 12 pools as described above. If the survey begins somewhere above the point of last known fish use or on a unmapped/untyped stream, then the waters below the survey effort down stream to the point of last known fish use will be typed by physical characteristics (see **WAC 222-16-031(3)(b)(i)**).

Waters downstream of a known fish location are assumed to have fish use, therefore, determinations of fish absence are not applicable in these cases.

For safety reasons and effectiveness in detecting fish, two person crews, one of which is a down stream netter, should be used for surveying most streams.

## **PART 5. QUALIFIED AND TRAINED STAFF**

“Qualified” staff means persons with at least a Bachelor of Science degree in a natural resource field with at least 12 credit hours in fish science course work and hands-on experience with backpack electroshockers and electrofishing. “Trained” staff means any personnel working under the direction or supervision of “qualified” staff who have also attended the survey training previously offered by Timber, Fish & Wildlife (TFW) cooperators.

## **PART 6. ALTERNATIVES FOR MAKING FISH USE DETERMINATIONS**

Where field surveys for determining fish use have not been done, water type is determined by applying the physical characteristics contained in **WAC 222-16-031(3)**. The DNR, in consultation with the WDFW, DOE, and affected Indian tribes may waive or modify these characteristics where evidence provides relative certainty that such waters do not support fish life. A list of such examples includes but may not be limited to:

1. Streams that have previously been surveyed and typing verified by projects sponsored or conducted by landowner, state, tribal and conservation groups. Project sponsors can define and map areas where water type confirmation has been substantially completed.
2. Waters with confirmed, long term, naturally occurring water quality parameters incapable of supporting fish life.

3. Snow melt/ice melt streams that have short flow cycles and are characteristic of east side sites. These streams typically have no flow in winter months and discontinue flow by June 1st.
4. Sufficient information about a geographic region or ownership is available to support a departure from the characteristics as determined by the DNR in consultation with the WDFW, DOE, and affected Indian tribes.

## **Section 14**

### **Survey Protocol for Marbled Murrelets**

**WAC 222-12-090 (14)** requires that the Pacific Seabird Group survey protocol in effect on January 6, 2003, be used to conduct marbled murrelet surveys. This document, formally titled *Methods for Surveying Marbled Murrelets in Forests: A Revised Protocol for Land Management and Research*, as well as a survey guidance document to assist in implementing the protocol, is available through DNR and Washington Department of Fish and Wildlife Olympia and regional offices. Landowners are encouraged to contact Washington Department of Fish and Wildlife for information regarding conducting protocol surveys.

# Section 15

## Guidelines for Estimating the Number of Marbled Murrelet Nesting Platforms

These guidelines accompany WAC 222-12-090(15) to help determine whether a forest stand contains sufficient potential marbled murrelet nesting platforms to require surveys for murrelets.

**PART 1. GENERAL DESCRIPTION OF MARBLED MURRELET HABITAT IN WASHINGTON** ..... 1

**PART 2. PROTOCOL PLATFORM ASSESSMENT METHODS** ..... 3

    Field Sampling Methods ..... 3

    Sample Plot Method - WAC 222-12-090(15)(a): ..... 4

        Table 15.1 Critical Value Table..... 5

    100% Cruise Method - WAC 222-12-090(15)(a): ..... 6

    Inventory Model Method - WAC 222-12-090(15)(b)..... 6

### **PART 1. GENERAL DESCRIPTION OF MARBLED MURRELET HABITAT IN WASHINGTON**

To conduct an efficient field inspection or preliminary assessment of potential marbled murrelet habitat, it is extremely valuable to be able to recognize the types of forests and forest conditions likely to be used by murrelets. This general description, when combined with reading additional details in the “Identification of Marbled Murrelet Nesting Structures” guide published by Washington Department of Fish and Wildlife, formal field training, and familiarity with known occupied sites, will assist in gaining proficiency in stand assessments. When conducting stand assessments in different regions of the state, the platform search image needs to be based on forest types of local occupied stands relative to geographical variation.

In Washington State, marbled murrelets typically nest within 50 miles of the marine shoreline in low-elevation, conifer, multi-layered canopy forests characterized by the presence of large diameter trees greater than 32”dbh. Potentially suitable murrelet nesting habitats are primarily old-growth and mature forests, but they may also include a variety of forest types including younger forests containing individual remnant older or deformed trees. When evaluating a stand for platform potential, it is important to consider the historical events and influences that may have created irregular structures. Nesting habitat may sometimes develop earlier in younger coastal forests with a high proportion of western hemlock. Douglas-fir dominated forests develop murrelet habitat characteristics at an older age. Forests with residual trees or other suitable stand attributes may be the products of windstorms, fire, local microclimates such as high humidity zones, previous logging operations that did not remove all trees, or high site productivity for regrowth of historic clearcuts. These stands usually exhibit a broad range of interior conditions often including snags, decaying down material, and moss.

Within the broad range of forests described above, the primary individual tree attribute for murrelet nests is the presence of marbled murrelet nesting platforms as described in WAC 222-16-010. Platforms may be the top of a large branch, forked limb, dwarf mistletoe infection, witches broom, deformities, overgrown broken tops, or other structure large enough to provide a useable surface for a nesting adult. Canopy cover directly over nests provides protection from predators and weather.

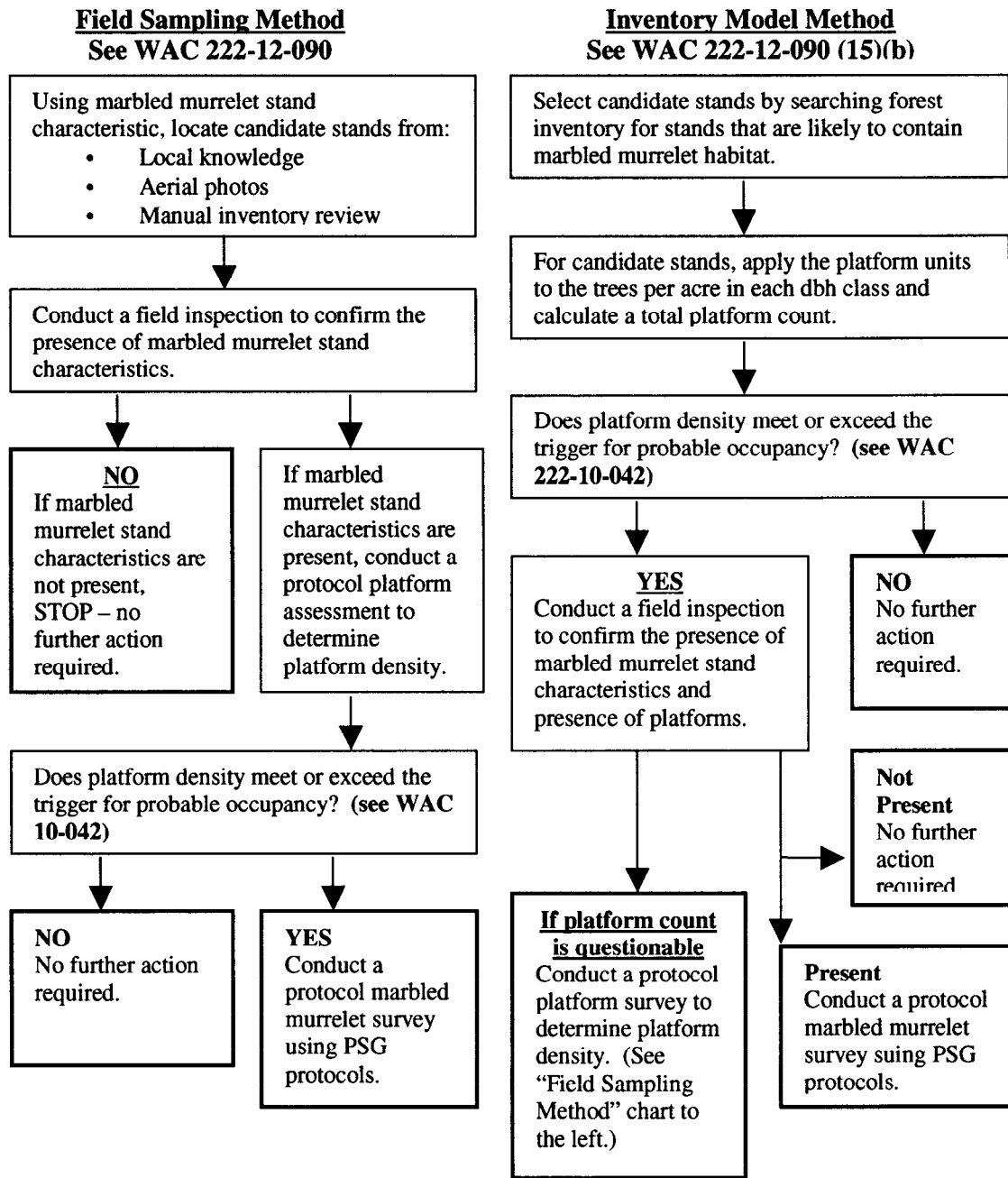


Examples of younger-aged Washington coastal forests which have suitable stand structure for platforms and have documented higher levels of murrelet occupancy include the “21 Blow” type, old second-growth in southwest Washington originating from early 1900’s harvest, areas where less efficient logging or high-grading methods were used, and unmanaged regrowth from late 1800’s fires or light burns. Small remnant stands of mature habitat in even-aged, managed forest landscapes appear to have a higher likelihood of occupancy when surrounded by pole size or older forests of any age rather than being isolated in clearcuts or young even-aged forests.

The basic example of unsuitable habitat are the even-aged, second growth forests of Douglas-fir in western Washington, which originated in the last 60 years. Some of those forests may indeed have large size classes of fast growing trees on high quality sites, but lack the large branches and irregular crown structures for platforms, cover, and moss potential.

For the purpose of habitat determination under Forest Practices rules, forest stands that have all of the following **forest stand characteristics** may have sufficient potential nesting platforms to require murrelet surveys:

1. Within 50 miles of marine waters
2. Contiguous forested area containing trees capable of providing nesting opportunities
3. At least 40% of the dominant and codominant trees are Douglas-fir, western hemlock, western red cedar or sitka spruce
4. At least 7 acres in size
5. Presence of large (32”+ dbh) trees
6. Generally multi-storied (2-3 layers)
7. Moderate canopy closure



**PART 2. PROTOCOL PLATFORM ASSESSMENT METHODS**

The process outlined below displays two alternative methods to determine whether or not there are enough platforms present in a stand to trigger murrelet surveys. The Field Sampling Method employs sampling of candidate stands selected using local knowledge, aerial photographs, and inventory data. The Inventory Model Method utilizes the results of a platform model developed to query an inventory system and predict the likelihood of platforms.

Field Sampling Methods

Select stands that meet murrelet forest stand characteristics and field review to confirm the findings. In some cases, the field review will be sufficient to decide that the presence of marbled murrelet

habitat, including the minimum density of platforms, is so obvious that further sampling is not needed. If the platform density meets or exceeds the trigger for probable occupancy, conduct a protocol marbled murrelet survey using the board-recognized Pacific Seabird Group (PSG) protocol in effect at the beginning of the season in which surveys are conducted. If the platform density is below the trigger for probable occupancy, bird surveys are not required. Where a field sampling is needed to determine the density of platforms in the stand, follow the methods described below.

1. Delineate the stand of contiguous habitat by field examination or use of aerial photos. Stands of similar habitat are considered contiguous unless separated by at least 300 feet of forest lacking platforms in 32” or greater diameter trees. Contiguous habitat includes adjacent areas outside the planned harvest boundaries that have similar stand structural characteristics or platform densities.
2. Use either the sample plot method or 100% cruise method to determine the number of platforms per acre. Consider using the 100% cruise method in stands that are smaller than approximately 25 acres.

Sample Plot Method - WAC 222-12-090(15)(a):

1. Locate 8 to 30 plot points on the photo using an appropriate systematic grid from a random starting point. (Depending on the variability of the occurrence of large trees and platforms in individual stands, a greater number of plots, up to 30, may yield greater precision in the sampling results.)
2. Locate plot centers at least 75 feet from the edge of the potential habitat being sampled.
3. The starting location and plot centers should be flagged for future relocation.
4. At each plot record the following within a 75-foot radius area (.4 acre plot):
  - Plot number
  - For all trees  $\geq 32$ " dbh
    - Species
    - dbh
    - Number of platforms by height and type
5. Within each plot, use one clear vantage point per tree  $\geq 32$ ? dbh to estimate the number of platforms. Follow the forest practices rule definitions for “marbled murrelet nesting platforms” found in WAC 222-16-010. For additional platform identification information, see the “Identification of Marbled Murrelet Nesting Structures” guide published by the Washington Department of Fish and Wildlife.
6. Conduct a single tailed t-test to determine if the platform density is significantly less than 2, 5, or 7 platforms per acre. The example below shows how a t-test is used in conjunction with a marbled murrelet survey.

Singled tailed t-test formula: 
$$t = \frac{\bar{x} - p}{s / \sqrt{n}}$$

- $\bar{x}$  = the average number of platforms/acre
- $p$  = minimum number of platforms required in assessment area
- $s$  = the standard deviation
- $n$  = the number of plots taken in the field
- $t$  = the calculated t-test value

Example:  $\bar{x} = 1.25; p = 2; s = 2.5; \text{ and } n = 8. \frac{1.25 - 2}{2.5 \sqrt{8}} \quad t = -0.848$

Once the t-test value is determined, compare it to the critical value associated with the number of plots taken in the survey on the table below.

**Table 15.1 Critical Value Table**

Number of Plots	Critical Value	Number of Plots	Critical Value	Number of Plots	Critical Value
8	- 1.895	16	- 1.753	24	- 1.714
9	- 1.860	17	- 1.746	25	- 1.711
10	- 1.833	18	- 1.740	26	- 1.708
11	- 1.812	19	- 1.734	27	- 1.706
12	- 1.796	20	- 1.729	28	- 1.703
13	- 1.782	21	- 1.725	29	- 1.701
14	- 1.771	22	- 1.721	30	- 1.699
15	- 1.761	23	- 1.717		

If the value of the t-test is greater than the critical value indicated on the Critical Value Table, assume that the unit meets the 2, 5, or 7 platforms per acre requirements, even if the average used in the calculation shows that the unit does not have sufficient platforms. In the example above, the negative t-test value of -0.848 is greater than the listed critical value of -1.895. Therefore, the platform density is not significantly less than 2, and a marbled murrelet protocol survey is required. The more variability in plot results, the more likely that this forest stand may not pass the t-test. In cases where there will be a great deal of variability between plots, it is generally better to increase the number of plots taken.

7. Additional plots maybe installed and added to the analysis to improve the sensitivity of the statistical t-test. However, current data suggests that more than 30 plots will not improve the test sensitivity enough to justify the effort.

100% Cruise Method - WAC 222-12-090(15)(a):

1. Overlay belt transects onto the air photo or stand map at one-acre spacing (i.e., transect centerlines are 208 ft. apart) so that 100% of the delineated stand is sampled. Transects should be uniquely identified and beginning and end points flagged in the field.
2. The observer should:
  - a. Traverse the centerline of each transect and record all trees > 32 inches dbh that are within 104 feet of the transect centerline.
  - b. Use one clear vantage point per tree > 32 inches dbh to estimate the number of potential platforms present.
  - c. Follow the guidelines in Forest Practices Rules, definitions section (**WAC 222-16-010**) and the “Identification of Marbled Murrelet Nesting Structures” guide published by the Washington Department of Fish and Wildlife to identify platforms.
3. To determine the average number of platforms per acre, total the number of observed platforms for all transects and divide by the number of acres in the delineated stand.

Inventory Model Method - WAC 222-12-090(15)(b)

Assumption: The landowner has a stand inventory of trees per acre for trees with 32” or larger diameter at breast height (dbh) and wishes to estimate the number of platforms per acre.

*Procedure:* Using a typical forest inventory, query for stands that are likely to contain murrelet habitat characteristics. For these stands, apply the Platform Units per Tree from the table below to the number of trees per acre in each dbh class. The accumulated total represents the number of platforms per acre in the stand. If the platform density meets or exceeds the threshold for probable occupancy, conduct a field inspection to confirm the presence of murrelet platform stand characteristics and conduct protocol marbled murrelet survey. If the platform density does not meet the threshold for probable occupancy, a protocol marbled murrelet survey is not required.

dbh Classes		Inventory Stand Tree Count per dbh Class (Average/Acre)	Platform Units per Tree	Platform Units per Class (trees/dbh class) (Platform Units/tree)
dbh Classes	Diameter Range			
32"	.32", <33"		0.37	
34"	.33", <35"		0.34	
36"	.35", <37"		0.33	
38"	.37", <39"		0.34	
40"	.39", <41"		0.39	
42"	.41", <43"		0.47	
44"	.43", <45"		0.56	
46"	.45", <47"		0.69	
48"	.47", <49"		0.84	
50"	.49", <51"		1.03	
52"	.51", <53"		1.26	
54"	.53", <55"		1.53	
56"	.55", <57"		1.86	
58"	.57", <59"		2.26	
.60"	.59"		2.75	
(Total of all Platform Units for all dbh Classes) = Platforms/Acre				

Example:

If a stand inventory shows 5 trees per acre (tpa) in the 32" dbh class, 4 tpa in the 38" class, and 3 tpa in the 42" class, and 1 tpa in the 48" class, the estimated platforms per acre would be calculated as shown below:

$$(5 * 0.37) + (4 * 0.34) + (3 * 0.47) + (1 * 0.84) = 5.46 \text{ platforms per acre}$$

*Note: This inventory model was developed using a sample of habitat stands in southwest Washington on private commercial timber lands. Although the model correctly identified most of the known occupied sites in a test sample, some occupied sites were missed by the model. Therefore, some caution is warranted when applying this model. A workgroup of interested stakeholders is currently developing a species specific inventory model method using a larger data set that should be ready for use during the 1999 survey season. This method will be proposed as a replacement to this section of the manual once complete.*

## Section 16

### Guidelines for Evaluating Potentially Unstable Slopes and Landforms

PART 1. INTRODUCTION .....	3
PART 2. LANDSLIDE TYPES IN WASHINGTON.....	4
2.1 Landslide Types and Effects .....	5
Table 1. Landslide Classification .....	6
Figure 1. Illustrations of the major types of landslide movement (all from Highland and Bobrowsky 2008, except the earth flows illustration is from U.S. Geological Survey 2004). ....	7
2.2 Shallow Landslide Types .....	8
Figure 2. Debris flow (DNR 2000). ....	8
Figure 3. Impounded water caused by landslide dam. ....	9
Figure 4. Left: Road-initiated debris flows in unstable landforms, Sygitowicz Creek, Whatcom County (Photo: DNR 1983). Right: Same hillslope 28 years later (2011 aerial photo). ....	10
2.3 Deep-Seated Landslides .....	10
Figure 5. Rotational deep-seated landslide. Rotational displacement of blocks of soil commonly occur at the head of the landslide (adapted from USGS 2004). ....	11
Figure 6. Left: Schematic of sequential instability within a rotational slide. ....	12
PART 3. SLOPE FORM .....	13
Figure 7a. Slope configurations as observed in map view. ....	14
Figure 7b. Slope configurations as observed in profile: convex, planar, and concave. ....	14
PART 4. CHARACTERISTICS OF UNSTABLE AND POTENTIALLY UNSTABLE SLOPES AND LANDFORMS.....	15
4.1 Bedrock Hollows, Convergent Headwalls, Inner Gorges .....	15
Figure 8. Typical hillslope relationships between bedrock hollows, convergent headwalls, and inner gorges (drawing by Jack Powell, DNR 2003). ....	15
Figure 9. Common hillslope relationship: bedrock hollows in convergent headwalls draining to inner gorges (photo and drawing by Jack Powell, DNR 2003). ....	16
Figure 10. Bedrock hollow and relationship to inner gorges (drawing by Jack Powell, DNR 2003). ....	17
Figure 11. Evolution of a bedrock hollow following a landslide (adapted from Dietrich et al. 1988; drawing by Jack Powell, DNR 2004). ....	17
Figure 12. Bedrock hollow slopes are measured at the steepest part of the slope, rather than along the axis (drawing by Jack Powell, DNR 2004). ....	18
Figure 13. Example of leave tree strips protecting unstable slopes .....	19
(photo by Venice Goetz, DNR 2004).....	19
Figure 14a. Stereo pair of a clearcut convergent headwall in Pistol Creek basin, North Fork Calawah River, Washington. ....	19
Figure 14b. Rotated topographic map and outline of convergent headwall displayed in the stereo pair of Figure 14a (Hunger Mountain and Snider Peak USGS 7.5' quadrangles). ....	20
Figure 15. Convergent headwall in North Fork Calawah River, Washington. ....	20
Figure 16. Cross-section of an inner gorge. This view emphasizes the abrupt steepening below the break-in-slope (drawing from Benda et al. 1998). ....	21
Figure 17. Photograph showing how debris flows help shape features related to inner gorges: over-steepened canyon wall; U-shaped profile; buried wood; and distinctive break-in-slope along margins of inner gorge (photo by Laura Vaugeois, DNR 2004). ....	22

4.2 Toes of Deep-Seated Landslides .....23  
 Figure 18. Deep-seated landslide showing the head scarp, side-scarps, body, and toe. ....23

4.3 Groundwater Recharge Areas for Glacial Deep-Seated Landslides .....23  
 Figure 19a. Extent of continental ice sheet in the Pacific Northwest (DNR 2014). ....24  
 Figure 19b. Continental and alpine glaciation in western Washington (DNR 2014). ....25  
 Figure 20. Hydrologic budget of a hillslope (University of Colorado). ....26  
 Figure 21. Diagram illustrating failure surface resulting from groundwater recharge to a glacial deep-seated landslide (DNR 2014). ....27

4.4 Outer Edges of Meander Bends .....28  
 Figure 22. Outer edge of a meander bend showing mass wasting on the outside of the bend and deposition on the inside of the bend (adapted from Varnes 1978). ....28

4.5 Areas Containing Features Indicating the Presence of Potential Slope Instability .....28

**PART 5. IDENTIFYING POTENTIALLY UNSTABLE SLOPES AND LANDFORMS .....30**

5.1 Office Review .....31  
 5.1.1 General Practitioner’s Office Review.....31  
 5.1.2 Qualified Expert’s Office Review .....32  
 5.1.3 Remote Sensing Tools Available for Office Reviews.....33  
 5.1.4 LiDAR Use in Identifying Potentially Unstable Landforms .....33  
 Figure 23. Example of a dormant glacial deep-seated landslide as seen in different types of remotely sensed data and with varying resolution quality:.....35  
 Figure 24. LiDAR image comparison between two deep-seated landslide scarps with the same resolution showing (a) subdued topography and (b) crisp topography.....36  
 Figure 25. Large slump feature showing displaced (deflected) streams within the landslide mass and sag ponds impounded by ridges (DNR 2016). ....36  
 Figure 26. LiDAR image showing channel incision within a large deep-seated slump feature in the Tolt River valley, King County (DNR 2016).....37

5.2 Field Assessment.....37  
 5.2.1 General Practitioner’s Field Assessment.....37  
 5.2.2 Qualified Expert’s Field Assessment .....38

5.3 Delineating Groundwater Recharge Areas for Glacial Deep-Seated Landslides.....40  
 Figure 27a. Glacial deep-seated landslide. The dash-lined polygon is an approximate delineation of a groundwater recharge area based on LiDAR data (DNR 2014). ....40  
 Figure 27b. Hillslope cross-section (A-A’ in figure 27a) derived from 2-meter DEM of a glacial deep-seated landslide showing the groundwater recharge area, geologic units, and generalized groundwater flow paths (DNR 2016).....41  
 5.3.1 Office Review for Groundwater Recharge Areas.....41  
 5.3.2 Field Assessment for Groundwater Recharge Areas .....42

**PART 6. ADDITIONAL ANALYSES FOR UNSTABLE SLOPES .....43**

6.1 Deep-Seated Landslide Activity Assessment.....43  
 Table 2. Guidelines for estimating deep-seated landslide activity level based on vegetation and morphology .....44

6.1.1 Glacial Deep-Seated Landslide Assessment .....45  
 6.2 Quantitative Field Assessment Methods for the Qualified Expert’s Subsurface Investigations..46  
 6.3 Water Budget and Hydrologic Contribution to Glacial Deep-Seated Landslides.....47  
 6.3.1 Modeling Evapotranspiration .....47  
 6.3.2 Groundwater Recharge and Groundwater Flow Modeling .....48  
 6.4 Computational Slope Stability Assessment Methods.....49  
 6.5 Runout and Delivery Assessment .....50



6.5.1 Landslide Types Associated with Rule-Identified Landforms .....	51
Table 3. Landslide types associated with rule-identified landforms. ....	52
6.5.2 Factors Influencing Debris Flow Runout .....	52
Figure 28. Debris flow characteristics relative to channel slope (adapted from Benda et al. 1998). ....	53
Figure 29. Slope distributions for depositional zones (discrete and gradual), transitional zones, erosional zones (incised and bedrock), and initiation sites for debris flows (from May 2002)..	54
6.5.3 Debris Fan Formation .....	55
Figure 30. Relation between average fan slope ( $S_f$ ) and Melton number ( $M_E$ ) for European landslide datasets. ....	56
6.5.4 Methods and Models for Predicting Shallow-Rapid Landslide Runout and Delivery .....	57
Figure 31. Cross section showing travel distance, travel distance angle, and slope geometry (Hunter and Fell 2003). ....	59
Figure 32. From USGS 7.5' Deadmans Hill Topographic Quadrangle. ....	61
6.5.5 Runout Mitigation Strategy: Barrier Trees .....	62
Figure 33. Debris flow path (from bottom to top of the photo) showing width changes from traveling through an older forest stand (Guthrie 2010). ....	62
6.5.6 Deep-Seated Landslide Runout Evaluation .....	63
Figure 34. LiDAR derived image revealing past glacial deep-seated landslide deposits in the Stillaguamish River valley. The crosshatch polygon marks the approximate extent of the 2014 SR 530 landslide. (DNR 2016). ....	63
PART 7. SYNTHESIS OF RESULTS, EVALUATION, AND GEOTECHNICAL REPORTS.....	64
7.1 Synthesis and Evaluation .....	64
7.2. Geotechnical Reports .....	65
GLOSSARY .....	68
REFERENCES .....	71
APPENDIX A – MEASUREMENTS OF SLOPE GRADIENTS.....	83
APPENDIX B – LANDSLIDE PROVINCES IN WASHINGTON .....	84
APPENDIX C – MAPS AND SURVEYS.....	86
APPENDIX D – EARTH IMAGERY AND PHOTOGRAMMETRY .....	88
APPENDIX E – LiDAR: PROCESSING, APPLICATIONS, AND DATA SOURCES .....	89
APPENDIX F – TECHNICAL REPORTS AND RESOURCES .....	91
APPENDIX G – PHYSICAL DATABASES .....	92
APPENDIX H – HYDROLOGIC PROPERTIES OF SOILS .....	93

## PART 1. INTRODUCTION

Board Manual Section 16 contains guidelines to evaluate potentially unstable slopes and landforms on forest lands. Like all Board Manual sections, it serves as an advisory technical supplement to the forest practices rules. The section:

- Provides general practitioners with tools to better understand potential landslide hazards and risks in the areas of proposed forest practices activities;
- Identifies when a qualified expert is needed;
- Assists qualified experts with tools and methods to conduct geotechnical investigations; and
- Provides guidance to prepare geotechnical reports.

The intended audience is:

- Landowners, foresters, and company engineers or private consultants, referred to in this section as “general practitioners”, who assist in field work; and
- Qualified experts, as that term is defined in WAC 222-10-030(5).

The current rules related to potentially unstable slopes and landforms were developed to avoid an increase over natural background rates from forest practices on high-risk sites at a landscape scale. The rules apply when it is determined that proposed forest practices activities may contribute to the *potential* for sediment and debris delivery to a public resource or cause a threat to public safety. When the potential for slope instability is recognized, the likelihood of landslide movement and damage must be considered. The factors in determining this likelihood could include initial failure volume, the nature of the landslide, slope or channel conditions, and potential runout distance.

Certain landforms are particularly susceptible to slope instability or indicate past slope instability. Forest practices applications (FPAs) proposing activities on or near these landforms may be classified Class IV-special and receive additional environmental review under the State Environmental Policy Act (SEPA). These landforms, commonly referred to as “rule identified landforms”, are listed in WAC 222-16-050(1)(d) and described in Part 4.

Board Manual Section 16 is composed of seven parts:

- Parts 2, 3, and 4 contain general background information for all readers on how to recognize the various landslide types in Washington State (Part 2), how slope form affects slope stability (Part 3), and how to recognize potentially unstable slopes and landforms (Part 4).
- Parts 5, 6, and 7 contain procedures and resources for conducting reviews and assessments of potentially unstable areas in relation to proposed forest practices. General practitioners will find 5.1.1 and 5.2.1 most useful for their office reviews and field assessments. The information in 6.5 will be useful to both general practitioners and qualified experts for landslide runout assessments. The remainder of Parts 5 and 6, and all of Part 7 provides guidance to qualified experts for conducting expert-level office reviews and field assessments and for preparing geotechnical reports.

The manual includes a glossary of terms that may not be familiar to many readers, references cited throughout the document, and appendices containing lists of informational resources.

## **PART 2. LANDSLIDE TYPES IN WASHINGTON**

Landslides occur naturally in forested basins and are an important geomorphic process in the delivery of wood and gravel to streams and nearshore environments. Wood and gravel play significant roles in creating stream diversity essential for fish habitat and spawning grounds.<sup>1</sup>

Landslide is a general term for any downslope movement of rock, unconsolidated sediment, soil, and/or organic matter under the influence of gravity. The term also refer to landslide deposits and slide materials in mountainous terrain that typically are separated from more stable underlying material by a zone of weakness, commonly referred to as the failure zone, plane, or surface.

---

<sup>1</sup> e.g., Reeves et al. 1995; Geertsema and Pojar 2007; Restrepo et al. 2009.

Landslides can be classified in several ways. The classification shown in 2.1 describes the type of movement (fall, topple, slide, spread, or flow) and the types of materials involved (rock, soil, earth, or debris). The failure surface can range from roughly planar (called translational), to curved (called rotational), or a combination of translational and rotational geometries (see Figure 1). Translational failures can also occur on non-planar surfaces (i.e., concave or convex) in shallow soils overlying bedrock on steep slopes<sup>2</sup> with little observed rotation or backward tilting of the slide mass.

Landslides can be small (a few cubic yards) or very large (millions of cubic yards). They can range from very fast moving as in free fall, to very slow as in creep. Landslides can come to rest quickly or can continue to move for years or even centuries. Landslides that stop moving only to be later reactivated are considered dormant slides while they are at rest. A landslide can also permanently cease moving and undergo erosion and revegetation over long periods of geologic time; this is a relict landslide.

Landslides occur when gravitational forces overcome the strength of the soil and rock on a slope. Factors contributing to slope instability may include:

- The presence of an impermeable stratigraphic layer underlying a permeable layer.
- Soil saturation by snowmelt, rain-on-snow events, or heavy and/or prolonged rains that can create instability in soil and weakened bedrock.
- Erosion by rivers, glaciers, or wave action that causes the over-steepening of slopes and removal of support from the base of the slopes.
- Ground shaking caused by earthquakes that increases the driving force and weakens the supporting soil structure.
- Adding excess weight to slopes from activities such as stockpiling of rock or earth, depositing road sidecast, and constructing landings.
- Timber harvest and road construction activities that weaken or remove the support for slopes, or increase runoff and groundwater recharge over a seasonal timescale or during prolonged heavy precipitation events.
- Diverting streams from one basin to another or concentrating water in unstable locations during road construction.

### 2.1 Landslide Types and Effects

Geologists and other professionals use several classification schemes to identify and describe landslides. The classification scheme of Varnes (1978), as modified by the U.S. Geological Survey (2004) and Hungr et al. (2001), is used for the purposes of this Board Manual section (see Table 1). This scheme is based on the type of movement and type of materials involved in the slope failure, with further classification possible based on the rate of movement. Hungr et al. (2001) proposed modifications to definitions of flow-type landslides, many of which are commonly associated with forest practices in Washington. For example, a debris flow is defined as a rapid flow of non-plastic debris within a steep stream channel, distinguished from a debris avalanche, which occurs on an open slope.

---

<sup>2</sup> Robison et al. 1999; Turner et al. 2010.

**Table 1. Landslide Classification**

Based on Varnes (1978) as modified by U.S. Geological Survey (2004) and Hungr (2001).

Type of Movement	Type of Material		
	Bedrock	Soils	
		Predominately Coarse	Predominately Fine <sup>3</sup>
Falls	Rock Fall	Debris Fall	Earth Fall
Topples	Rock Topple	Debris Topple	Earth Topple
Slides	Rotational	Rock Slide	Debris Slide
	Translational		
Lateral Spreads	Rock Spread	Debris Spread	Earth Spread
Flows-Confined	Rock Flow	Debris Flow	Earth Flow
Flows-Unconfined	Rock Avalanche	Debris Avalanche	Debris Flood
Complex	Combination of two or more principal types of movement		

Landslides are described by terms referring to the type of material and method of movement (rock fall, debris flow, and so forth). Materials in a landslide mass are either rock or soil (or both) and may include organic debris. In this context, soil is composed of sand-sized or finer particles and debris is composed of coarser fragments. The types of movement describe the internal mechanics of how the landslide mass is displaced: fall, topple, slide, spread, or flow. The types of landslides commonly found in forested areas in Washington are slides and flows.

Landslides may also occur as a complex failure encompassing more than one type of movement. A common example is a debris slide that evolves into a debris flow. Less common, but potentially of great import, are deep-seated landslides that periodically fail as a debris flow or debris avalanche. Some of the landslide types shown in Table 1 can be further divided into shallow or deep-seated depending on whether the failure plane is above (shallow) or below (deep) the rooting depth of trees. Figure 1 shows simplified illustrations of the major types of landslides.

---

<sup>3</sup> The terms used in the “Predominately Fine” column are seldom used in the forest environment where coarse materials including wood are common.



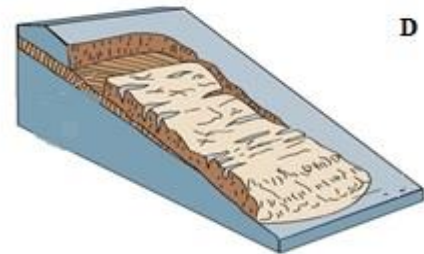
**Falls:** Falls occur when a mass of rock or soil detaches from a steep slope or cliff, and are often caused by the undercutting of the slope. The failure is typically rapid to very rapid. The fallen mass may continue down the slope until the terrain flattens.



**Topples:** Landslides where the forward rotation of a mass of rock or soil breaks away or 'topples' from the slope. Their failure rates range from extremely slow to extremely fast.



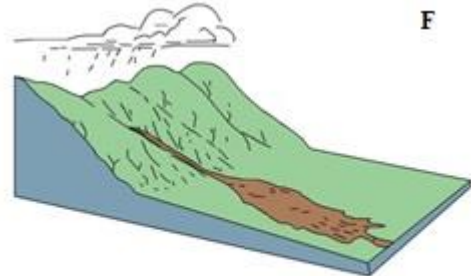
**Rotational slides:** Landslides where the surface of rupture is concave-up and the slide movement is rotational about an axis that is parallel to the contour of the slope



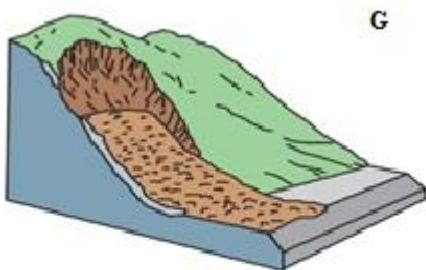
**Translational slides:** Landslides where the surface of the rupture is roughly planar with a surface roughly parallel to the ground surface. These are called rock slides, block slides, slab slides, or debris slides.



**Lateral spreads:** Landslides that generally occur on very gentle or level slopes and are caused by subsidence of a fractured mass of cohesive material into softer, often liquefied underlying material.



**Debris flows:** Channelized landslides where loose rock, soil, and organic matter combine with water to form a slurry that flows rapidly downslope.



**Debris avalanches:** Rapid to extremely rapid shallow flows of partially or fully saturated debris on steep unconfined slopes.



**Earth flows:** Landslides consisting of fine-grained soil or clay-bearing weathered bedrock. They can occur on gentle to moderate slopes. Overall, there is little or no rotation of the slide mass.

*Figure 1. Illustrations of the major types of landslide movement (all from Highland and Bobrowsky 2008, except the earth flows illustration is from U.S. Geological Survey 2004).*

## 2.2 Shallow Landslide Types

Shallow landslides are unstable features that typically fail within the vegetation rooting zone and may respond to rainfall events over periods of days to weeks. They occur on a variety of landforms including bedrock hollows, convergent headwalls, inner gorges, toes of deep-seated landslides, the outer edges of meander bends, and in other areas with steep slopes. Reduced root strength in slide prone areas resulting from timber harvest, fire and other natural processes can contribute to slope failure. Additionally, the amount of water and the materials contained within shallow landslides can affect the manner and distance in which they move.

*Debris slides* consist of aggregations of coarse soil, rock, and vegetation that lack significant water and move at speeds ranging from very slow to rapid by sliding or rolling forward. The results are irregular hummocky deposits that are typically poorly sorted and non-stratified. If debris slides entrain enough water, they can become debris flows.

*Debris flows* are channelized slurries composed of sediment, water, vegetation, and other debris. Solids typically constitute more than 60% of the volume.<sup>4</sup> Debris flows usually occur in steep channels when debris becomes charged with water (from soil water or upon entering a stream channel) and liquefies as it breaks up. Channelized debris flows often entrain material and can significantly bulk up in volume during transport. These landslides can travel thousands of feet or miles from the point of initiation, scouring the channel to bedrock in steeper channels. Debris flows commonly slow where the channel makes a sharp bend and stop where the channel slope gradient becomes gentler than about 3 degrees (6%), or the valley bottom becomes wider and allows the flow to spread out. Hyper-concentrated floods may travel greater distances and on lower gradient slopes than debris flows based on their water content.<sup>5</sup>



Figure 2. Debris flow (DNR 2000).

*Debris avalanches.* Hungr et al. (2001) defined a debris avalanche as a very rapid to extremely rapid shallow flow of partially or fully saturated debris on steep slopes without confinement in an established channel. Sharpe (1938) described a debris avalanche as morphologically similar to a snow avalanche. Debris avalanches may enter steep drainage channels and become debris flows.

---

<sup>4</sup> Pierson and Scott 1985.

<sup>5</sup> Iverson and Reid 1992.

Therefore, the term debris avalanche is reserved for events that remain poorly channeled without a defined recurrent path or laterally bounded deposition landform.

*Dam break floods* are a subset of flow-type landslides defined as very rapid surging flows of water heavily charged with debris in a steep channel.<sup>6</sup> They contain a mixture of water and sediment (dominantly sand-sized) and organic debris with solids that range between 20% and 60% by volume.<sup>7</sup> In forested mountains, they are commonly caused by the collapse of dams, such as those formed by landslide dams (Figure 3) or debris jams. Impounded water and debris released when the dam is breached sends a flood wave down the channel that exceeds the magnitude of normal floods and generally extends beyond the range of influence that has been documented for debris flows.<sup>8</sup> Such floods can rise higher than normal rainfall or snowmelt-induced flows along relatively confined valley bottoms, driving flood waters, sediment, and wood loads to elevations high above the active channel, or the active floodplain.

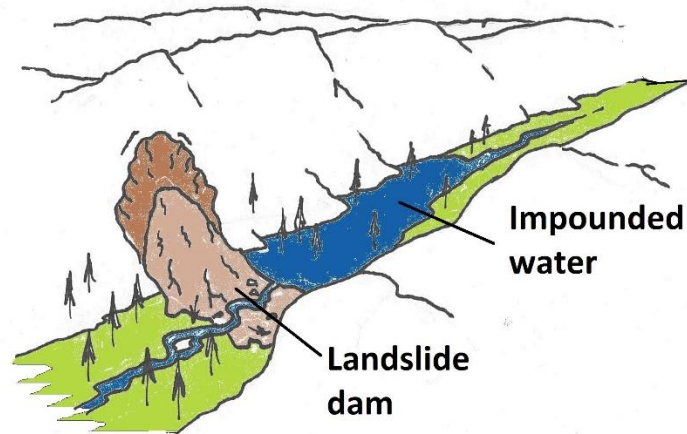


Figure 3. Impounded water caused by landslide dam.

Debris flows and dam break floods can occur in any potentially unstable terrain with susceptible valley geometry. In natural systems, debris flows and dam break floods are responsible for moving sediment and woody debris from hillslopes and small channels down into larger streams. They can also scour channel reaches, disturb riparian areas, deposit debris onto salmonid spawning areas, elevate turbidity, adversely affect water quality downstream, and threaten public safety.

---

<sup>6</sup> Hungr et al. 2001.

<sup>7</sup> Pierson and Scott 1985.

<sup>8</sup> Johnson 1991.



Figure 4. Left: Road-initiated debris flows in unstable landforms, Sygitowicz Creek, Whatcom County (Photo: DNR 1983). Right: Same hillslope 28 years later (2011 aerial photo).

The photo on the left in Figure 4 shows debris flows that coalesced and, after exiting the confined channel at the base of the slope, spread into a 1,000-foot wide swath for a distance of 2,000 feet before entering the South Fork Nooksack River. Between the base of the slope and the river, the debris flow affected a county road, residential sites, and more than 60 acres of cultivated farm fields. The photo on the right shows the same hillslope after harvest with trees left in the bedrock hollows and inner gorges.

### 2.3 Deep-Seated Landslides

Deep-seated landslides are those in which the slide plane or zone of movement is typically below the maximum rooting depth of forest trees (generally greater than 10 feet). They may extend to hundreds of feet in depth and may involve underlying bedrock. They can be a wide range of sizes up to several miles across. Deep-seated slides may respond to rainfall events over periods of days to weeks, or weather patterns over months to years or even decades.<sup>9</sup>

Deep-seated landslides can occur almost anywhere on a hillslope. Many occur in the lower portions of hillslopes and extend directly into stream channels, whereas those confined to upper slopes may lack connectivity to deposit material directly into channels. They occur in weak materials such as thinly layered rocks, unconsolidated sediments, deeply weathered bedrock, or rocks with closely spaced fractures. They can also occur where a weak layer is present in otherwise strong rocks. Deep-seated landslides in glacial deposits are usually associated with hydrologic responses in the permeable glacial materials overlying less permeable materials.

There are three main parts of a deep-seated landslide: the scarps (head and side); the body, which is the displaced slide material; and the toe, which also consists of displaced materials (Figure 5). A deep-seated landslide may have one or more of these component parts because small deep-seated landslides can be found within larger slides. The head and side scarps together form an arcuate or

<sup>9</sup> Washington State Department of Emergency Management 2013.



horseshoe shaped feature that represents the surface expression of the rupture plane. The body and toe area usually display hummocky topography, and the flow path of streams on these landslide sections may be displaced in irregular patterns due to differential movement of discrete landslide blocks. The parts of deep-seated landslides that are most susceptible to shallow landslides and potential sediment delivery are steep scarps (including marginal stream sideslopes) and toe edges.

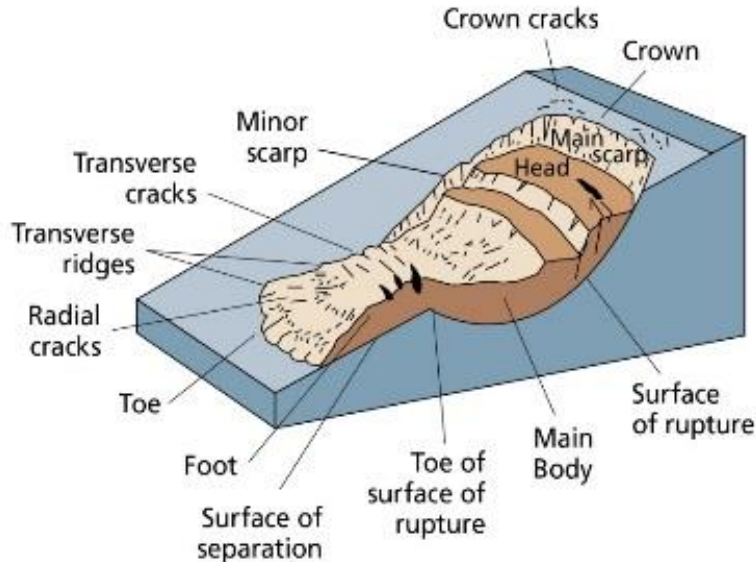


Figure 5. Rotational deep-seated landslide. Rotational displacement of blocks of soil commonly occur at the head of the landslide (adapted from USGS 2004).

Movement of deep-seated landslides can be complex, ranging from slow to rapid, and may include numerous small to large horizontal and vertical displacements triggered by one or more failure mechanisms.<sup>10</sup> Deep-seated landslides are often part of large landslide complexes, parts of which can be intermittently active for hundreds of years or more.<sup>11</sup> The bodies and toes of deep-seated landslides and earth flows consist of incoherent collapsed materials weakened from previous movement. Because the original mass experienced movement, the disrupted portions of a landslide may be subject to secondary deep landsliding or debris flow initiation. As a result, sediment delivery can occur from shallow landslides on steep stream-adjacent toes of deep-seated landslides, and from steep side slopes along marginal stream channels within the bodies of deep-seated landslides.

Purely rotational slumps (Figure 5) in cohesive soils are rare in nature because the shape of the rupture surface usually departs from constant curvature.<sup>12</sup> Instead, as the host slump moves, internal deformation during transport may cause segmentation of the failure surfaces, resulting in the evolution of secondary landslides in hummocky terrain, which are more prone to saturation and movement.<sup>13</sup> Landslides may fail sequentially, exhibiting multiple instabilities containing smaller secondary landslides within a host landslide during a single event, from secondary movements over time, or a combination of both. The term compound is used by Cronin (1992) to describe large host landslides that encompass smaller secondary slides.

<sup>10</sup> Roering et al. 2005.

<sup>11</sup> Bovis 1985; Keefer and Johnson 1983.

<sup>12</sup> Hungr 2014.

<sup>13</sup> Cronin 1992.

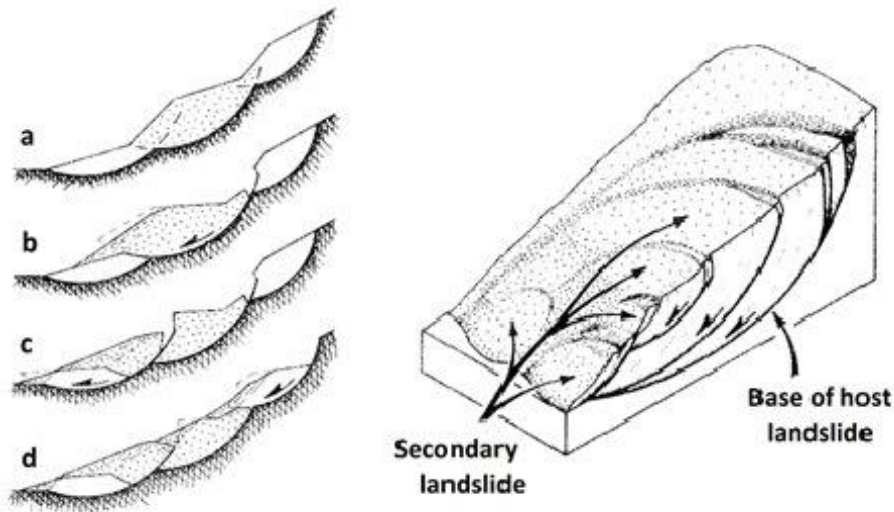


Figure 6. Left: Schematic of sequential instability within a rotational slide. The original slope configuration a) initially at rest until sliding movement begins, at which time the b) middle (stippled) slump mass loads the lower slide, removing support from the upper scarp. As the lower landslide mass becomes active, c) it may rotate outward, causing the d) unsupported upper slide mass to fail. Right: Block diagram of a compound landslide, showing a variety of secondary landslides within the host landslide (adapted from Cronin, 1992).

Some compound deep-seated landslides found in glaciated and non-glaciated terrain have the potential to become highly mobile failures. The SR 530 landslide in the Stillaguamish River valley is an active rotational glacial deep-seated failure that hosted both a debris flow/avalanche and a rotational slide<sup>14</sup> and raised awareness regarding the potential range of activity within large failures particularly in areas underlain by glacial sediments. Unlike shallow (translational) landslides and debris flows that may occur repeatedly and are better understood, secondary failures within compound landslides are less common and present an unrecognized hazard potential.

Triggering mechanisms of deep-seated landslides can result from over-steepening of the toe by natural means such as glacial erosion or fluvial undercutting (channel incision), earthquakes, or human activities such as excavating for land development.<sup>15</sup> Movement in landslides is usually triggered by accumulations of water at the slide zone; therefore, land-use changes that alter the amount or timing of water delivered to a landslide can initiate or accelerate movement.<sup>16</sup> Initiation or re-initiation of such landslides has also been associated with increases in groundwater levels<sup>17</sup> from individual storms or in response to seasonal accumulation from rainfall or snowmelt, depending on soil and bedrock properties, and the degradation of material strength through natural processes. When subsurface water is presumed to influence the movement of a deep-seated landslide, the process used to identify how groundwater affects the slide zone should be appropriate for the geologic materials within the landslide.

<sup>14</sup> Keaton et al. 2014.

<sup>15</sup> Schuster and Wieczorek 2002.

<sup>16</sup> Cronin 1992.

<sup>17</sup> van Asch et al. 2005.

The loss of tree canopy interception of moisture and the reduction in evapotranspiration through timber removal on areas up-gradient of the slide may also initiate movement of the slide. However, deep-seated landslide movement can be diverse and influenced by geomorphic and hydrologic factors, and is not always associated with up gradient groundwater sources.<sup>18</sup> Generally, avoiding the following practices will minimize human-caused re-initiation or acceleration of deep-seated landslide movement: removing material during road construction or quarrying at the toe; overloading slopes by placing spoils on the upper or mid-scarp areas; changing subsurface hydrology by excessive soil compaction; and directing additional water into the slide from road drainage or captured streams.

Recent advances in high-resolution LiDAR (Light Detection and Ranging) have demonstrated it to be a highly effective tool for identifying the footprint of dormant and active deep-seated landslides. Larger landslides can usually be identified from LiDAR imagery, topographic maps, and aerial photos, whereas smaller landslides are more difficult to identify and often require a field inspection. For information on how LiDAR is used for identifying potentially unstable landforms see Parts 5.1.4 and 6.5.6.

### **PART 3. SLOPE FORM**

Slope form is an important concept when considering the mechanisms behind shallow landsliding. Understanding and recognizing the differences in slope form is essential to identifying potentially unstable landforms. There are three major slope forms observed when looking across the slope (contour direction): divergent (ridgetop); planar (straight); and convergent (spoon-shaped) (Figure 7a). Landslides can occur on any of these slope forms but divergent slopes tend to be more stable than convergent slopes because water and debris spread out on divergent slopes, whereas water and debris concentrate on convergent slopes. Convergent slopes tend to lead into the stream network, encouraging delivery of landslide debris to the stream system. Planar slopes are generally less stable than divergent slopes but more stable than convergent slopes. In the vertical direction, ridges are convex areas (bulging outward) and tend to be more stable than planar (straight) mid-slopes and concave areas (sloping inward) (Figure 7b).

Slope steepness can play a significant role in shallow landsliding. Steeper slopes tend to be less stable. The soil mantle, depending on its make-up, has a natural angle at which it is relatively stable (natural angle of repose). When hillslopes evolve to be steeper than the natural angle of repose of the soil mantle, the hillslope is less stable and more prone to shallow landslides, especially with the addition of water. The combination of steep slopes and convergent topography has the highest potential for shallow landsliding.

---

<sup>18</sup> van Asch et al. 2009.

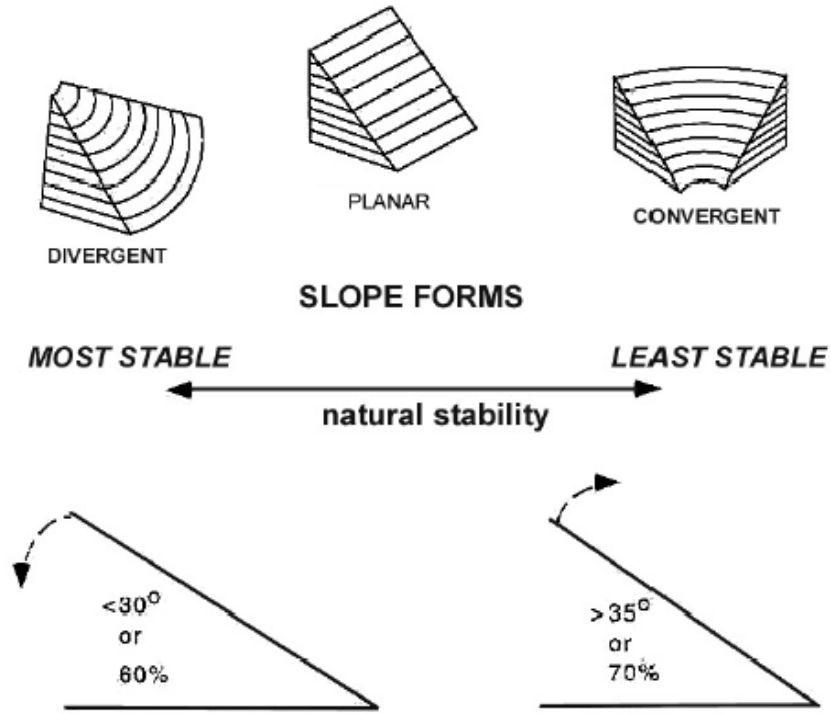


Figure 7a. Slope configurations as observed in map view.

Figure 7a shows three major slope forms (divergent, planar, and convergent) and their relative stability. These terms refer to the contour directions across a slope. Typically, convergent areas with slope gradients equal to or greater than 35 degrees (70%) are at a higher risk of sliding.<sup>19</sup>

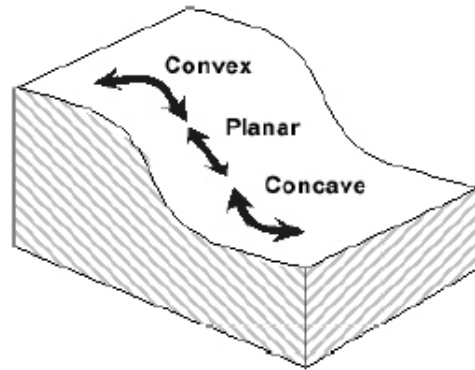


Figure 7b. Slope configurations as observed in profile: convex, planar, and concave. These terms refer to up and down directions along a slope (drawing by Jack Powell, DNR 2004).

<sup>19</sup> Benda et al. 1997.

#### **PART 4. CHARACTERISTICS OF UNSTABLE AND POTENTIALLY UNSTABLE SLOPES AND LANDFORMS**

This part describes the characteristics of the potentially unstable slopes and landforms listed in WAC 222-16-050(1)(d)(i), commonly referred to as “rule-identified landforms.” They are listed in the rule from (A) to (E) as follows:

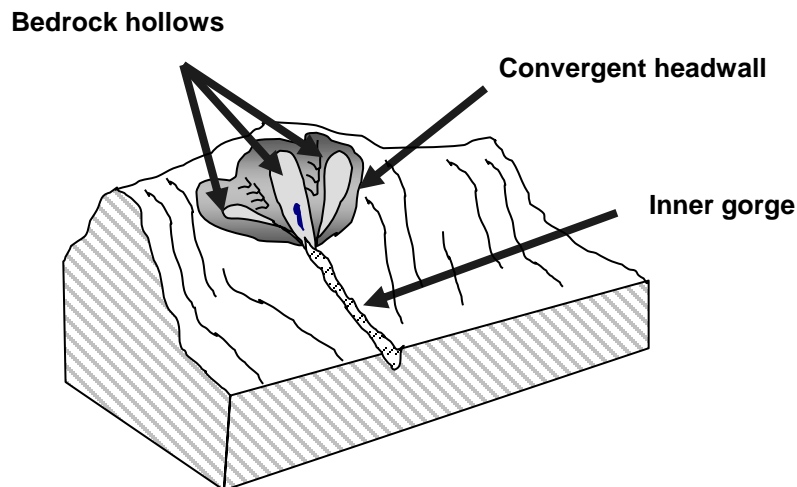
- A. Inner gorges, convergent headwalls, or bedrock hollows with slopes steeper than 35 degrees (>70%) (see 4.1);
- B. Toes of deep-seated landslides with slopes steeper than 33 degrees (>65%) (see 4.2);
- C. Groundwater recharge areas for glacial deep-seated landslides (see 4.3);
- D. Outer edges of meander bends along valley walls or high terraces of an unconfined meandering stream (see 4.4); or
- E. Any areas containing features indicating the presence of potential slope instability, which cumulatively indicate the presence of unstable slopes (see 4.5).

The rule-identified landforms represent the most common landforms with the potential to fail in response to natural and management factors. They can be identified with a combination of topographic and geologic maps, aerial photographs, LiDAR data, and a variety of private and public agency-derived landform screening maps and tools. Field observation is needed to verify their presence and precisely delineate landform boundaries, measure gradients, and note other characteristics. In addition to the information provided in Part 4, guidance for identifying potentially unstable landforms is offered in Part 5.

In most instances, the terms described here are also used in the scientific literature. For the purposes of Washington forest practices, the rule-identified landform terms, definitions, and descriptions supersede those used in the scientific literature. Note that all sizes, widths, lengths, and depths are approximate for the following discussion and are not part of the rule-identified landform definitions unless parameters (degrees and percent) are specifically provided. Appendix A provides information on measurements of slope gradients.

##### 4.1 Bedrock Hollows, Convergent Headwalls, Inner Gorges

These three landforms are commonly found together as shown in Figures 8 and 9.



*Figure 8. Typical hillslope relationships between bedrock hollows, convergent headwalls, and inner gorges (drawing by Jack Powell, DNR 2003).*

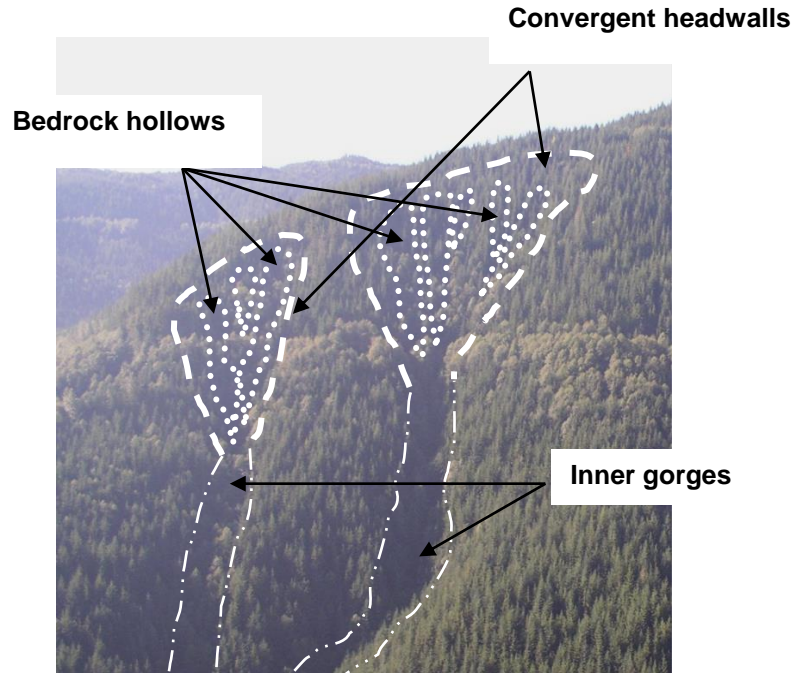


Figure 9. Common hillslope relationship: bedrock hollows in convergent headwalls draining to inner gorges (photo and drawing by Jack Powell, DNR 2003).

*Bedrock hollows* are also called colluvium-filled bedrock hollows, zero-order basins, swales, bedrock depressions, or simply hollows.<sup>20</sup> Not all hollows contain bedrock so the term “bedrock” hollow can be a misnomer. In the forest practices rule context, the bedrock hollows listed in category A are hollows formed in bedrock. Hollows formed in other materials, such as glacial outwash without a bedrock substrate may also show signs of instability. These would need evaluation similar to hollows containing bedrock and would fit into category E of the rule.

Bedrock hollows are commonly spoon-shaped areas of convergent topography with concave profiles on hillslopes. They tend to be oriented linearly up- and down-slope. Their upper ends can extend to the ridge or begin as much as several hundred feet below the ridgeline. Most bedrock hollows are approximately 75 to 200 feet wide at their apex (but they can also be as narrow as several feet across at the top), and narrow to 30 to 60 feet downhill. Bedrock hollows should not be confused with other hillslope depressions such as small valleys, sag areas (closed depressions) on the bodies of large deep-seated landslides, tree windthrow holes (pit and mound topography), or low-gradient swales.

Bedrock hollows often form on other landforms such as head scarps and toes of deep-seated landslides. Bedrock hollows can occur singly or in clusters that define a convergent headwall. They commonly drain into inner gorges (Figure 10).

<sup>20</sup> Crozier et al. 1990; Dietrich et al. 1986.

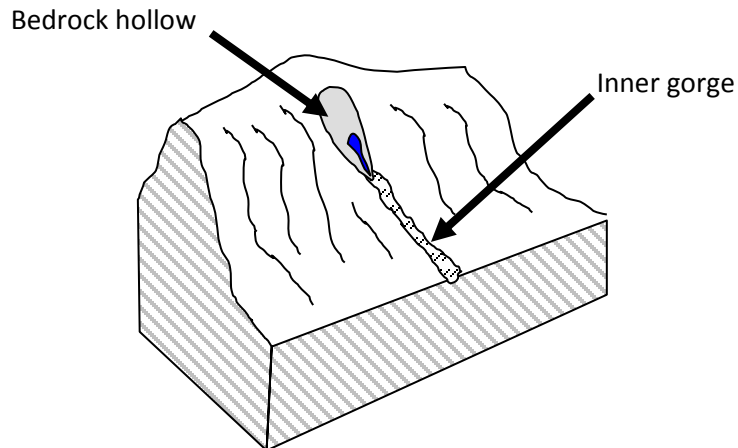


Figure 10. Bedrock hollow and relationship to inner gorges (drawing by Jack Powell, DNR 2003).

Bedrock hollows usually terminate where distinct channels begin. This is at the point of channel initiation where water emerges from a slope and has carved an actual incision. Steep bedrock hollows typically undergo episodic evacuation of debris by shallow rapid mass movement (a debris flow) followed by slow refilling with colluvium that takes years or decades. Unless they have recently experienced evacuation by a landslide, bedrock hollows are partially or completely filled with colluvial soils that are typically deeper than those on adjacent planar slopes. Recently evacuated bedrock hollows may have water flowing along their axis, whereas partially evacuated bedrock hollows will have springs until they fill with sufficient colluvium to allow water to flow subsurface.

Figure 11 illustrates the evolution of a bedrock hollow. Drawing “a” shows that over a period of tens to hundreds or thousands of years in some places, sediment accumulates in a hollow. When the soil approaches a depth of 3 to 6 feet, the likelihood of landslides increases. Recurrent landslide activity within the bedrock hollow slowly erodes bedrock and maintains the form of the bedrock hollow (drawing “b”). After a landslide occurs in a bedrock hollow, seeps or springs may be exposed and the risk of additional sliding diminishes. Drawing “c” shows soil from the surrounding hillsides (colluvium) slowly re-filling the bedrock hollow. As vegetation and trees establish the site after past failures, the roots help stabilize the soil.

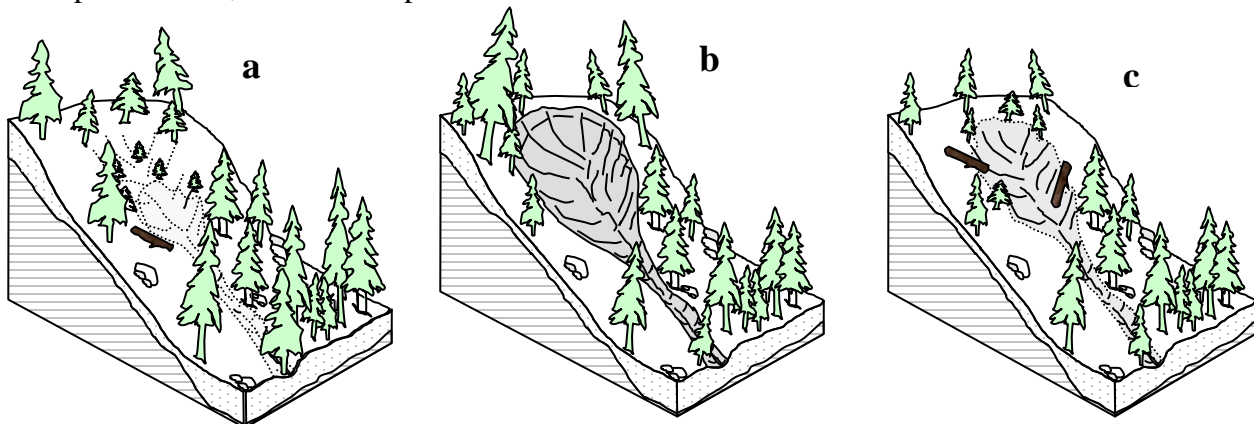


Figure 11. Evolution of a bedrock hollow following a landslide (adapted from Dietrich et al. 1988; drawing by Jack Powell, DNR 2004).

The common angle of repose for dry, cohesion-less materials is about 36 degrees (72%), and saturated soils can become unstable at lower gradients. Thus, slopes steeper than about 35 degrees (70%) are considered susceptible to shallow debris slides. Bedrock hollows form on slopes of varying steepness. Bedrock hollows with slopes steeper than 35 degrees (70%) are potentially unstable in well-consolidated materials, whereas bedrock hollows in poorly consolidated materials may be unstable at lower angles. For the purpose of this document and when considering slope instability, bedrock hollow slopes are measured on the steepest part of the slope, and generally not along the axis unless the bedrock hollow is full (Figure 12).

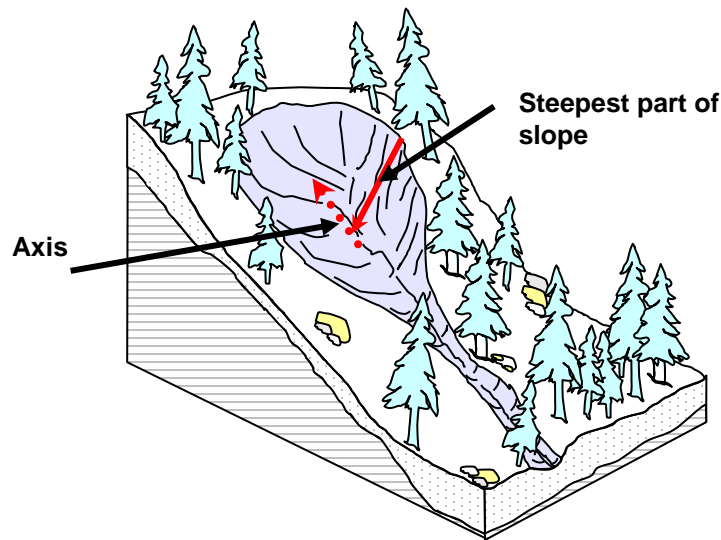


Figure 12. Bedrock hollow slopes are measured at the steepest part of the slope, rather than along the axis (drawing by Jack Powell, DNR 2004).

Vegetation can provide cohesion on marginally stable slopes and removes water from the soil through evapotranspiration. Leave trees in steep, landslide-prone bedrock hollows help maintain rooting strength and should reduce the likelihood of landslide activity<sup>21</sup> (Figures 4 and 13). However, windthrow of the residual trees following harvest can be associated with debris slide or debris flow events. In high wind environments, harvest practices that will limit the susceptibility of the residual trees to windthrow and reduce the potential for landslides include leaving wider strips, pruning or topping trees in the strips, or feathering the edges of leave tree strips.

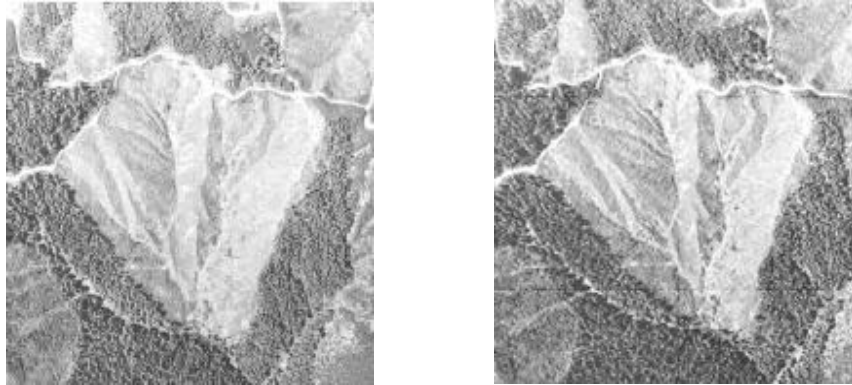
<sup>21</sup> Montgomery et al. 2000.



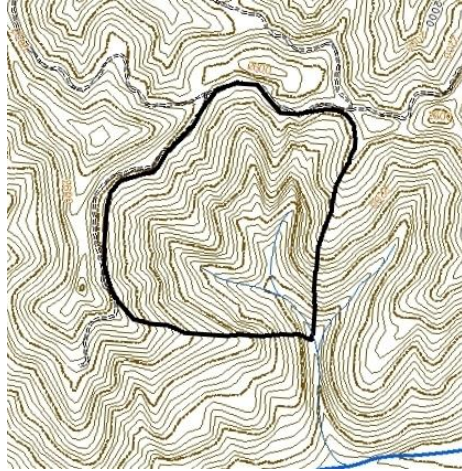


*Figure 13. Example of leave tree strips protecting unstable slopes (photo by Venice Goetz, DNR 2004).*

*Convergent headwalls* are funnel-shaped landforms, broad at the ridgetop and terminating where headwaters converge into a single channel. A series of converging bedrock hollows may form the upper part of a convergent headwall. Convergent headwalls are broadly concave both longitudinally and across the slope, but may contain sharp ridges that separate the bedrock hollows or headwater channels (Figures 14a and 14b).



*Figure 14a. Stereo pair of a clearcut convergent headwall in Pistol Creek basin, North Fork Calawah River, Washington.*



*Figure 14b. Rotated topographic map and outline of convergent headwall displayed in the stereo pair of Figure 14a (Hunger Mountain and Snider Peak USGS 7.5' quadrangles).*

Convergent headwalls generally range from about 30 to 300 acres. Slope gradients are typically steeper than 35 degrees (70%) and may exceed 45 degrees (94%). Soils are thin because landslides are frequent in these landforms. History of erosion and landslide activity can be evident by a lack of vegetation or mature trees on the site, or the presence of early seral plant communities such as grasses or red alder. It is the arrangement of bedrock hollows and first-order channels on the landscape that causes a convergent headwall to be a unique mass wasting feature. The convergent shape of the slope, coupled with thin soils, may allow for a more rapid onset of soil saturation. The mass wasting response of these landforms due to storms, disturbances such as fire, and forest practices activities is much greater than is observed on other steep hillslopes in the same geologic settings. The convergent headwall in Figure 15 contains approximately 25 bedrock hollows (not visible through the canopy), and eons of high erosion caused the entire ridgeline to set back several hundred feet from that of the extended hillslope. Landslide scars from convergent headwalls may be prone to surface erosion.



*Figure 15. Convergent headwall in North Fork Calawah River, Washington.*

Channel gradients are extremely steep within convergent headwalls, and generally remain so for long distances downstream. Landslides that evolve into debris flows in convergent headwalls typically deliver debris to larger channels below. Channels that form below headwalls are formed by repeated debris flow erosion. Debris fans are commonly found at the base of their slopes.

*Inner gorges* are canyons created by a combination of stream down-cutting and mass movement on slope walls.<sup>22</sup> Inner gorges are steep, straight or concave, side slope walls, which commonly have a distinctive break in slope (Figure 16). Debris flows shape inner gorges by scouring the stream, undercutting side slopes, and/or depositing material within or adjacent to the channel (Figure 17). Inner gorge side slopes may show evidence of recent landslides, such as raw non-vegetated slopes, young even-aged disturbance vegetation, or areas that are convergent in contour and concave in profile. Because of steep slopes and proximity to water, landslide activity in inner gorges is highly likely to deliver sediment to streams or structures downhill. Exceptions can occur where benches of sufficient size to stop moving material exist along the gorge walls.

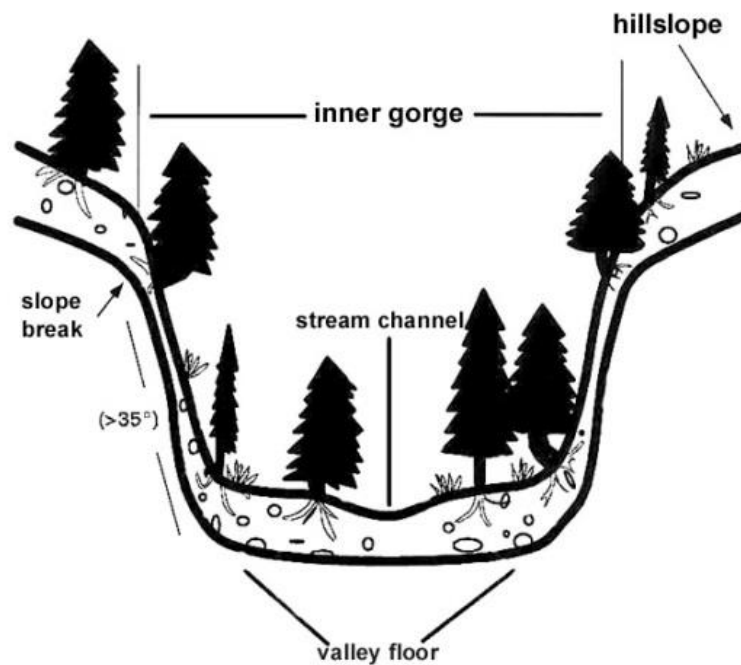


Figure 16. Cross-section of an inner gorge. This view emphasizes the abrupt steepening below the break-in-slope (drawing from Benda et al. 1998).

<sup>22</sup> Kelsey 1988.



*Figure 17. Photograph showing how debris flows help shape features related to inner gorges: over-steepened canyon wall; U-shaped profile; buried wood; and distinctive break-in-slope along margins of inner gorge (photo by Laura Vaugeois, DNR 2004).*

The geometry of inner gorges varies from simple to complex. Steep inner gorge walls can be continuous for great lengths, such as along a highly confined stream that is actively down cutting, but there may also be gentler slopes between steeper ones along valley walls. Inner gorges can be asymmetrical with one side being steeper than the other side. Stream-eroded valley sides along main stem rivers can be V-shaped with distinct slope breaks at the top. These commonly show evidence of small-scale landsliding but do not display severe impact, such as hillslope inner gorges which tend to be U-shaped. In practice, a minimum vertical height of 10 feet is usually applied to distinguish between inner gorges and slightly incised streams.

The upper boundary of an inner gorge is assumed to be a line along the first break in slope of at least 10 degrees, or the line above which gradients are mostly less than 35 degrees (70%) and convex. The delineating break-in-slope occurs where over-steepened slopes related to inner gorge erosion processes intersect slopes formed from normal hillslope erosion processes. While the upper inner gorge boundary is typically distinct, in some places it can be subtle and challenging to discern. Inner gorge slopes tend to be especially unstable at the point where the slope breaks because the abrupt change in gradient causes subsurface water to collect within the soil matrix. This can increase the likelihood of landslide activity. Similar to bedrock hollows, inner gorge slopes are measured along the steepest portion of the slope (see Figure 12).

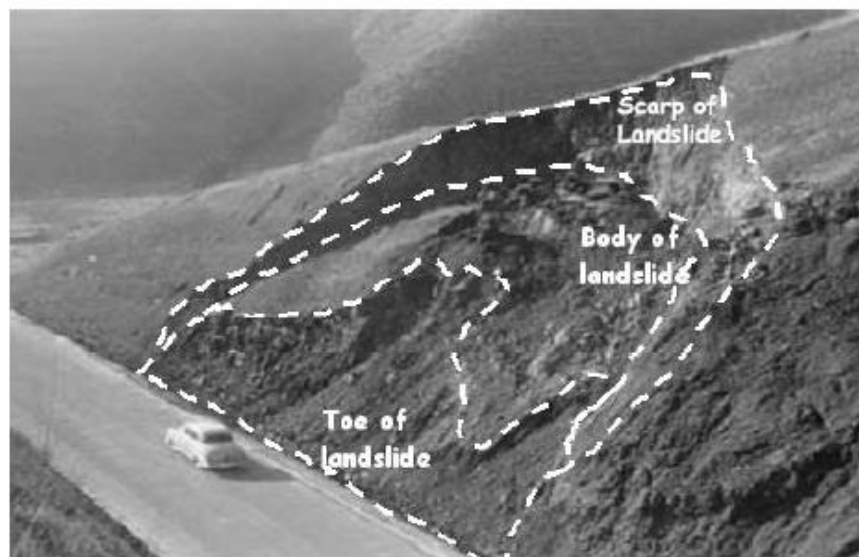
The steepness of inner gorges depends on the underlying materials. In competent bedrock, gradients of 35 degrees (70%) or steeper can be maintained, but soil mantles are sensitive to root strength loss at these angles. Slope gradients as gentle as 28 degrees (53%) can be unstable in inner gorges cut into incompetent bedrock, weathered materials, or unconsolidated deposits.

Stream erosion creates instability by undercutting the toe of the slopes in an inner gorge. Erosion along the inner gorge walls may be exacerbated by the interception of shallow groundwater, which forms seeps along the sides of the inner gorge. Root strength along walls and margins of inner gorges provides soil stability and lessens the rates of mass wasting. Inner gorge areas can lose root

strength when trees blow down. However, downed timber has a buttressing effect providing some slope reinforcement. Effective rooting width of forest trees is approximately the same as the crown width. In some instances, where the inner gorge feature is highly unstable, it is necessary to maintain trees beyond the slope break. The rooting strength of trees adjacent to the landform can often provide additional support.

#### 4.2 Toes of Deep-Seated Landslides

The toe of a landslide is the lower, displaced material most distant from the place of origin or main scarp. Toes of deep-seated landslides with slopes greater than 33 degrees (65%) are a rule-identified landform. In this context, toes of deep-seated landslides means the downslope toe edges, not the entire toe area of displacement material. Figures 5 and 18 show the toe in relation to other landslide features.



*Figure 18. Deep-seated landslide showing the head scarp, side-scarps, body, and toe. Some of the toe was removed in building and maintaining the highway (adapted from a USGS photo).*

Landslides with toe edges adjacent to streams have a high potential for delivery of sediment and wood to streams through natural processes. In such situations, streams can undercut the landslide toes and promote movement. Over-steepened toes of deep-seated landslides can also be sensitive to changes caused by harvest and road construction. The road shown in Figure 18 removed a portion of the toe, causing reactivation of the landslide. Resulting instability can take the form of shallow landslides, small-scale slumping, or reactivation of parts or the whole of a landslide. Because deep-seated landslides occur in weak materials (further weakened by previous movement), an angle of 33 degrees (65%) is the regulatory threshold used on the potentially unstable toe edges. Regardless of the surface expression of the toe, it is best to avoid disrupting the balance of the landslide mass by cutting into or removing material from the toe area.

#### 4.3 Groundwater Recharge Areas for Glacial Deep-Seated Landslides

Groundwater recharge areas for glacial deep-seated landslides are rule-identified landforms. Part 5.3 provides methods for delineating these areas. In order to identify and delineate a groundwater recharge area in glacial terrain, it is necessary to first identify the associated landslide.

Glacial deep-seated landslides are landslide features where most of the slide plane or zone lies within glacial deposits. The depth of the glacial deposits extends below the maximum rooting depth of trees, to depths ranging from tens to hundreds of feet beneath the ground surface. Glacial deep-seated landslides are distinguished from other forms of deep-seated landslides by the materials in which they occur; however, their failure mechanics can be similar to deep-seated landslides developed in other materials.<sup>23</sup>

Glacial deep-seated landslides occur in continental or alpine glacial deposits, or a combination of both. The continental glacial deposits in Washington are located in the northern areas of the state (Figure 19a), and the alpine glacial deposits (Figure 19b) are found in mid-to-high elevation mountain ranges.<sup>24</sup>



Figure 19a. Extent of continental ice sheet in the Pacific Northwest (DNR 2014).

<sup>23</sup> Terzhagi 1951.

<sup>24</sup> Booth et al. 2003; Booth et al. 1994; Thorsen, R.M. 1980; Barnosky 1984; Heusser 1973; Crandall 1965.

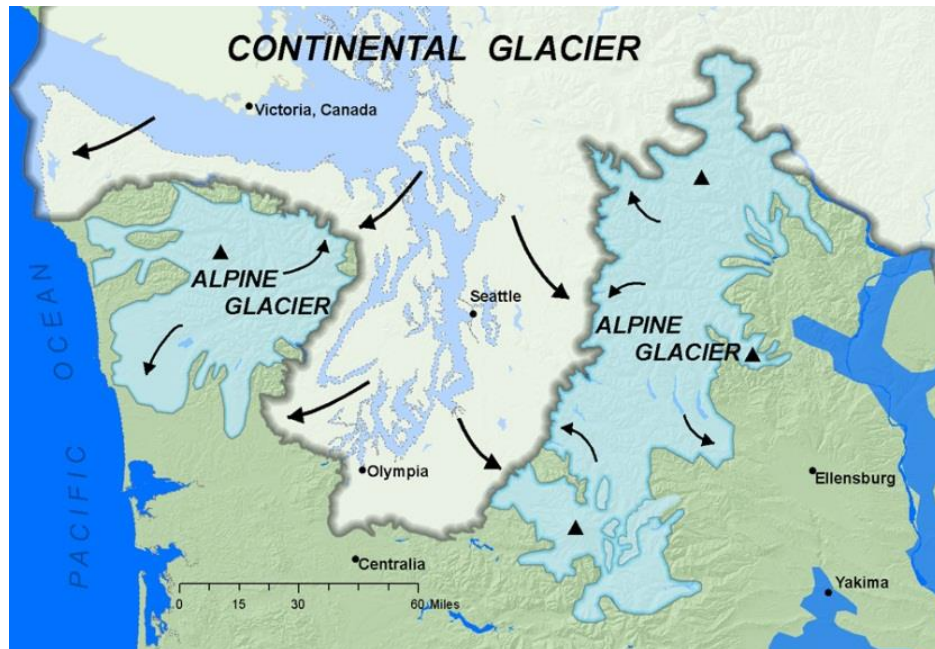


Figure 19b. Continental and alpine glaciation in western Washington (DNR 2014).

Glacial deep-seated landslides can involve rotational and translational movement or flows, or a combination of movement types. They can occur in any type of glacial deposit including till, outwash, glaciolacustrine and glaciomarine silt and clay, or a mix of multiple glacial strata. During interglacial periods, layers of loess (e.g., windblown silt and clay) and fluvial sediments were deposited on the surface of glacial deposits or became overlain by glacial deposits from successive glaciations.

Glacial and interglacial deposits display a wide range of hydrogeologic characteristics, including permeability (the rate water moves through a geologic material) and storage capacity (the amount of water released or taken into storage per unit area of geologic material for a given change in hydraulic head). Glacial till is comprised of unsorted and non-stratified glacial materials (ranging in size from clay to boulders) deposited or overrun by glacial ice during periods when the ice was advancing. Till typically has low permeability and low water storage capacity. Glacial outwash typically contains sorted and stratified sediments deposited by water flowing from glacial ice during the advance or the retreat of the glacier, and have higher permeability and water storage capacity than glacial till. Glaciolacustrine deposits are typically fine-grained silts and clays deposited in ice-marginal lakes. Glaciomarine deposits are similar to glaciolacustrine deposits except the materials are deposited directly into marine waters. Glaciomarine and glaciolacustrine deposits typically have low permeability and low storage capacity, similar to glacial till. See Appendix H for the hydrologic properties of various soils.

Glacial deep-seated landslides can be affected by the hydrologic budget of an area (Figure 20). The hydrologic budget is the amount of groundwater present and is calculated based on precipitation (rain and snow), interception of precipitation by vegetation, evapotranspiration, surface storage, surface runoff, and groundwater recharge. Groundwater recharge is the component of a hydrologic budget that infiltrates into the subsurface below the vegetative rooting zone. The groundwater component is composed of water within the unsaturated and saturated zones.

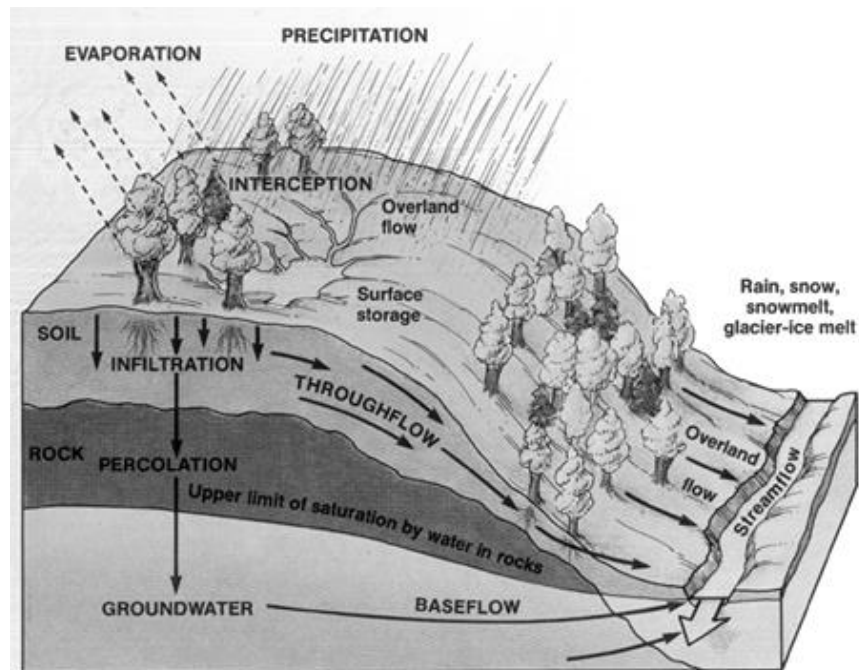


Figure 20. Hydrologic budget of a hillslope (University of Colorado).

Groundwater recharge to a glacial deep-seated landslide can occur in several ways. Groundwater may originate from adjacent non-glacial materials that flows into glacial sediments, or runoff from upland non-glacial materials that contributes groundwater recharge within glacial sediments. A contributing component of groundwater recharge can also be surface flow.

The area that contributes groundwater to a glacial deep-seated landslide, including the landslide itself, constitutes that landslide's groundwater recharge area. However, parts of the landslide may not be hydrologically connected to glacial material, sediments, or deposits. Groundwater flows originating in upland areas can discharge as springs, streams, and other surface water features at lower elevations.

Differences in permeability within glacial sediments control the infiltration and movement of groundwater within the recharge area.<sup>25</sup> Groundwater perching and routing, and the characteristics of the overlying groundwater recharge area can be important factors in a deep-seated failure. This is especially true for landslides in glacial sand and other unconsolidated deposits that overlie less permeable strata such as fine-grained glacial lake deposits, till, or bedrock (Figure 21). This is a common configuration of the glacial deposits in much of the Puget Lowlands (e.g., landslides in Seattle)<sup>26</sup> and in the North Cascades foothill river valleys (e.g., the Stillaguamish River valley)<sup>27</sup>, but also occurs in alpine glacial deposits elsewhere in Washington apart from the maximum extent of continental glaciation.

A common example of failure is where groundwater is flowing through permeable sand layers perched above the less permeable clay or till layers. Glacial deep-seated landslides can respond to precipitation events, where the permeable layer (e.g., sand and gravel from recessional outwashes)

<sup>25</sup> Bauer and Mastin 1997; Vaccaro et al. 1998.

<sup>26</sup> Gerstel et al. 1997.

<sup>27</sup> Benda et al. 1988.



becomes saturated above a less permeable layer (e.g., glaciolacustrine clay), forming a perched groundwater table that weakens the contact between the clay and sand. Saturated conditions can increase soil pore water pressure and reduce the soil strength causing landslide failure planes to occur along these sand/clay contacts. A common predictor of perched groundwater is the presence of springs (groundwater discharge) or hydrophytic (moisture loving) vegetation. Groundwater discharging as springs along the sand-clay contact can aid draining of the aquifer.

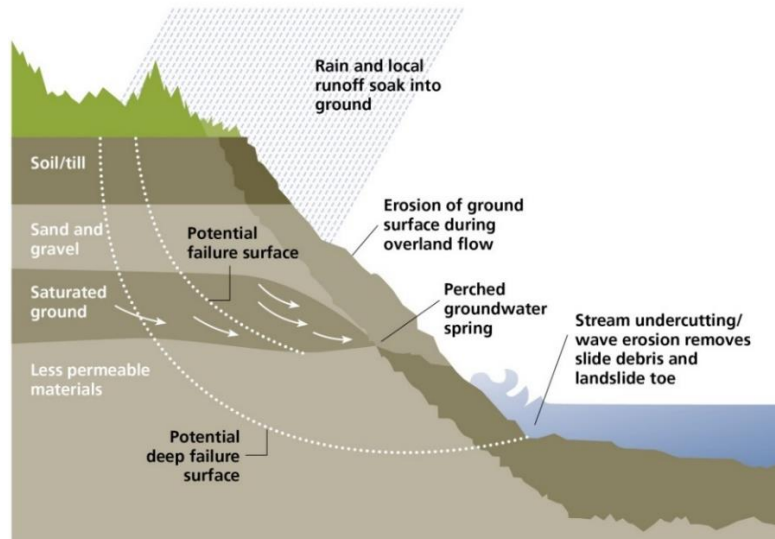


Figure 21. Diagram illustrating failure surface resulting from groundwater recharge to a glacial deep-seated landslide (DNR 2014).

A classic example of a geologic setting where glacial deep-seated landslides are common is in the Puget Sound lowlands where Esperance Sand or Vashon advance outwash overlies Lawton Clay. In this setting, groundwater recharge from precipitation infiltrates downward within the hillslope until it encounters the relatively impermeable Lawton Clay. Because the water cannot infiltrate into the Lawton Clay at the same rate it is supplied from above, the water table rises vertically above the clay surface. The elevated water table increases the pressure within the Esperance Sand and forms a hydraulic gradient that causes water to flow horizontally along the sand-clay contact, resulting in springs where this contact is exposed at the surface.<sup>28</sup>

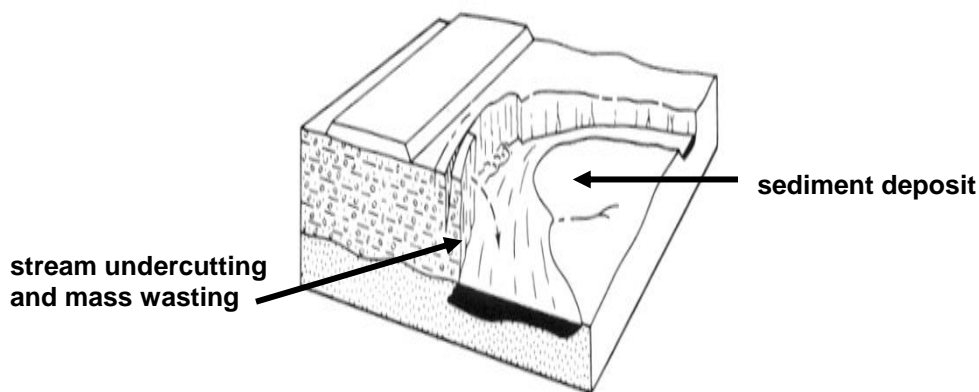
Saturation of the pore spaces within sediments reduces grain-to-grain contact, which reduces the effective strength of materials. Because soil saturation reduces the effective strength of the soil, which in turn reduces the stability of a slope, certain forest practices activities proposed within recharge areas for glacial deep-seated landslides may be classified Class IV-special per WAC 222-16-050(1)(d)(i)(C). Such proposals require further investigation and documentation prepared by a qualified expert. Therefore, it is important to characterize groundwater recharge areas and stratigraphy in terms of the potential for changes in the water balance due to forest practices activities, and the degree to which a potential hydrologic change is delivered to a glacial deep-seated landslide.

<sup>28</sup> Tubbs 1974.

The first order approximation of the recharge area is the surface basin (topographically defined) directly above and including the landslide. The spatial extent of a groundwater recharge area can be interpreted from LiDAR data, field observation of soil profiles, geologic structure, stratigraphy, well logs or boreholes, and geologic maps, to the extent these resources are applicable. See 5.3 for guidance on delineating groundwater recharge areas for deep-seated landslides.

#### 4.4 Outer Edges of Meander Bends

Streams can create unstable slopes by undercutting the outer edges of meander bends along valley walls or high terraces of an unconfined meandering stream.<sup>29</sup> The outer edges of meander bends are susceptible to deep-seated and shallow landslide activity, including debris avalanching and small-scale slumping. They are less susceptible where mature trees exist on lower terraced slopes in riparian or channel migration zones. The roots and woody structure of riparian trees act to deflect erosive flows and lessen undercutting along meander bend walls.



*Figure 22. Outer edge of a meander bend showing mass wasting on the outside of the bend and deposition on the inside of the bend (adapted from Varnes 1978).*

#### 4.5 Areas Containing Features Indicating the Presence of Potential Slope Instability

Apart from the rule-identified landforms described above, there are other slope indicators that can point to instability. When the feature or landform indicates the presence of slope instability that cumulatively indicates the presence of unstable slopes, the area can be considered a rule-identified landform. Proposed forest practices activities in this situation may be classed as a Class IV-special per WAC 222-16-050(1)(d)(i)(E) if there is potential to deliver sediment and debris to a public resource or threaten public safety. General practitioners and qualified experts commonly refer to these features as “category E” landforms.

Active bedrock deep-seated landslides are an example of a category E landform because they display multiple indicators of slope instability. Toes greater than 33 degrees (65%) are a rule-identified landform, but other areas, such as portions of the head scarp within a bedrock deep-seated landslide, may have shallow landslide and delivery potential and require protection.

Another common example of a category E landform is concave features greater than 35 degrees (70%) in glacial sediments or unconsolidated sediments such as Quaternary terrace deposits. These features are not true bedrock hollows because bedrock is not present, but landslide inventories from

<sup>29</sup> Schuster and Wieczorek 2002.

watershed analyses and landslide hazard projects have demonstrated that these features are unstable and routinely recognized and protected as category E landforms.

Relatively large and recent topographic indicators of such features can be observed from air photos, topographic maps, and LiDAR images, but identifying smaller and older indicators requires careful field observation. Indicators of slope instability or active movement may include the following:

#### Topographic indicators

- Bare or raw, exposed, non-vegetated soil on steep slopes. This condition may mark the location of a debris flow, or the headwall or sidewall of a slide or evidence of active movement.
- Benched or back tilted surfaces, especially below crescent-shaped headwalls, indicative of rotational movement within the slide.
- Hummocky topography at the base of steep slopes. This may mark the accumulation zone (runout area) for a flow or slide.
- Boulder piles or fresh deposits of rock, soil, or other debris at the base of a slope.
- Tension cracks in the surface (across or along slopes, or in roads). Tension cracks may mark the location of an incipient headwall scarp or a minor scarp within the body of an existing slide.
- Pressure ridges typically occur in the body or toe of the slide and may be associated with hummocky topography.
- Intact sections (blocks) having localized horst and graben topography.
- Transverse ridges and radial cracks on landslide displacement material.
- Stratigraphic indicators including disconformities, offset contacts, and overturned sections.
- Side scarps, shear margins, or lateral scarps; multiple scarps in a downward direction.
- Displaced surface features like roads, railroads, foundations, and fence lines.
- Presence of debris fans at the mouths of canyons indicating past runout events.

#### Hydrologic indicators

- Sag ponds (ponded water) in tension cracks or low depressions in poorly drained areas on the hillslope or landslide body. These conditions are often associated with hummocky topography which can be a signature of landslide activity.
- Seepage lines or spring and groundwater piping. These conditions often mark the contact between high permeability and low permeability soils.
- Deflected or displaced streams (streams that have moved laterally to accommodate landslide deposits).
- Chaotic drainage patterns resulting from landslide activity.

#### Vegetative indicators

- Jack-strawed, back-rotated, or leaning trees and stumps. These are typically indicative of active or recently active landslides.
- Trees with curved-based lower stems and vertical upper boles may indicate slope movement stabilizing over time.
- Bowed, kinked, or pistol-butted trees. These are typically indicative of soil creep, but may indicate incipient landsliding, particularly if other indicators are present.
- Split trees and split old growth stumps. These may be associated with tension cracks.

- Hydrophytic (water-loving) vegetation (skunk cabbage, devil’s club, salmon berry, etc.) on slopes. These conditions may indicate the presence of groundwater seeps and associated hydrogeologic conditions.
- Patterns of disturbed vegetation such as changes in stand composition (early seral stage or lack of mature trees within a hillslope) or small groupings of alder in a conifer-dominated forest may indicate recent or historic slope failure.

No single indicator necessarily proves that slope movement is happening or imminent, but a combination of several could indicate a potentially unstable site.

Additional information about landslide processes, techniques for hazard assessment, and management practices on unstable terrain is available in, “A Guide for Management of Landslide-Prone Terrain in the Pacific Northwest” by the British Columbia Ministry of Forests<sup>30</sup>; Hillslope Stability and Land Use<sup>31</sup>; Landslides, Processes, Prediction and Land Use<sup>32</sup>; and Slope Stability Reference Guide for National Forests in the United States<sup>33</sup>.

## **PART 5. IDENTIFYING POTENTIALLY UNSTABLE SLOPES AND LANDFORMS**

The identification, delineation, and characterization of unstable and potentially unstable landforms should be completed to address the relevant questions for each site. Each step of the review process might uncover new information that could modify assessment methods and findings. General practitioners (landowners, foresters, engineers) typically conduct an initial screening and field review of project sites. In some cases, a qualified expert may be engaged to review and verify the general practitioner’s slope assessment or perform additional geologic investigation.

The steps in the investigation process typically include an office review (5.1) and field assessments (5.2 and 5.3). If desired by the landowner or required by rule, further geotechnical assessments may include those described in Parts 6 and 7 as follows:

- deep-seated landslide activity assessment (6.1);
- glacial deep-seated landslide assessment (6.1.1);
- quantitative field assessment methods for qualified experts’ subsurface investigations (6.2);
- water budget and slope stability modeling assessments for glacial deep seated landslides (6.3);
- slope stability sensitivity assessment (6.4);
- runout and delivery assessment (6.5);
- synthesis and evaluation (7.1); and
- geotechnical reports (7.2).

The appropriate investigation process cannot be defined by the rigid application of a set of procedural rules.<sup>34</sup> The following is a general overview of the typical sequence and elements of a slope-stability assessment:

---

<sup>30</sup> Chatwin et al. 1994.

<sup>31</sup> Sidle et al. 1985.

<sup>32</sup> Sidle and 2006.

<sup>33</sup> Hall et al. 1994.

<sup>34</sup> Turner and McGuffey 1996.

1. Preliminary fact-finding to answer: What actions do the proposed forest practices activities include (e.g., partial cut, clearcut, road building, stream crossing)? In which landslide province (Appendix B) are the proposed forest practices activities located and what are the geologic conditions and types of landforms expected to be present? Are any site-specific resources available for review, such as previously completed geotechnical reports or watershed analysis reports?
2. Office review of geologic maps, topographic maps, aerial photographs, LiDAR data, and other information identified during the preliminary fact-finding phase.
3. Field review to confirm office review findings, and identify unstable and potentially unstable landforms not recognized during the office review. The field review may also involve a more detailed geologic investigation for collecting additional geologic data and hydrogeologic mapping.
4. Data analysis and assessment regarding the potential for landslide activity that could result from the proposed forest practices activity, and the potential for delivery of sediment to public resources or threats to public safety.

### 5.1 Office Review

An office review is the initial screening of a selected site using available remotely sensed information and previously prepared materials or documents (e.g., reports, studies, field data, and analyses). Remote sensing generally refers to information that can be acquired for a particular site or physical feature without visiting the site or collecting data in the field.

A typical office review involves compiling and evaluating all pertinent site-specific and regional data to help identify, delineate, and interpret potentially unstable slopes and landforms (e.g., aerial imagery, LiDAR, GIS-based model predictions of surface attributes derived from digital high-resolution topographic data). It may also include existing documents and databases (e.g., maps, geotechnical reports and studies, published and unpublished scientific literature, landslide inventories, local and regional databases containing meteorologic, hydrologic, and geologic information) to screen sites for potential slope stability concerns, identify public resource and public safety considerations, and make a determination regarding next steps in the site assessment. See Parts 5.1.3 and 5.1.4 for information regarding remote sensing tools and topographic data, and appendices C through E for data sources.

#### 5.1.1 General Practitioner's Office Review

The objectives of the general practitioner's office review are to identify and locate potential and existing areas of slope instability within or around proposed forest practices activities using descriptions provided in Part 4; locate areas of public resource sensitivity or public safety exposure in the area of the planned operations that could be adversely affected by mass wasting processes; and to develop a strategy for assessing the landforms in the field. The general practitioner can use this information when completing a Forest Practices Application (FPA).

#### *Summary of Procedures.*

The following are typical resources for a general practitioner's office review:

- Maps and imagery to screen areas for visual indicators of potentially unstable slopes and landforms. Relevant maps typically include surface topography and its derivatives (e.g., slope class maps), hydrology (e.g., streams and water types), geology and soils (e.g., rock units, soil types), landslides (landslide inventories and hazard zonation), and information needed to

identify public safety exposures (e.g., road networks, parcel boundaries with existing building structure information). Imagery includes aerial photography and LiDAR-derived hillshade images available on public websites and referenced in Appendix D.

- Publicly available documents that might identify site-specific slope stability concerns or place the site in a broader landscape context with regard to potentially unstable landforms and processes (e.g., watershed analyses conducted under chapter 222-22 WAC; see Appendix F for a list of online sources).
- Sources that may be available to the user online via the Forest Practices Application Review System (FPARS) and Washington State Geologic Information Portal. The Geographic Information System (GIS) with map display and analysis capabilities (e.g., ESRI ArcGIS) can provide an efficient and spatially accurate means for overlaying digital maps and images for geospatial analysis. However, if these tools are not available, an initial screening can be performed manually by inspecting each map or image separately. Various county websites also offer online interactive GIS information for maps and imagery products. Sources of imagery, data, maps, reports, and other documents are listed in appendices C through G.

In addition, the general practitioner's past knowledge about site-specific conditions will supplement the information gathered during the office review process.

The office review may not identify all potential unstable landforms, particularly if features are too small or subtle to be identified from available maps and imagery. For example, identifying the full extent of a groundwater recharge area from topographic maps, or detecting landslides under a mature forest canopy using aerial photography exclusively may be unreliable. Therefore, one or more follow-up field assessments can verify results of the initial screening. The final step of an office review may be to create a site map for field use showing areas of potential slope stability concerns, natural resource sensitivities, and public safety exposures within or around the proposed operation.

#### *Outcome.*

The initial office review will help the general practitioner determine any portions of the proposed harvest and construction area that may need further assessment in the field. The general practitioner might also elect to have a more thorough office review conducted by a qualified expert.

#### 5.1.2 Qualified Expert's Office Review

A qualified expert is needed when an investigation of potentially unstable slopes is beyond a general practitioner's expertise, or when activities are proposed on rule-identified landforms. The qualified expert's objective is to develop a preliminary geologic assessment of landform characteristics and landslide potential prior to initiating field work. The qualified expert's office review is generally more in-depth than a general practitioner's initial screening, and applies professional expertise in engineering geology, hydrogeology, geomorphology, and associated fields to detect and interpret landscape processes.

Depending on the site-specific conditions and the proposed forest practices activities, the qualified expert typically:

1. Screens the site with pertinent data in order to identify physical indicators of past, existing, and potential landslide instability, noting their spatial and temporal distributions;

2. Delineates on preliminary maps the identified features and associated potentially unstable landforms;
3. Formulates initial hypotheses regarding landslide and landform behavior and failure mechanisms to be evaluated further in the field; and
4. Determines the type and level of field investigation needed to assess any potential for delivery of sediment or debris to a public resource or threat to public safety.

#### *Summary of Procedures.*

Most qualified experts have GIS capabilities, are experienced in using remotely sensed data techniques and modeling tools, and can provide feedback on proposed forest practices activities in relation to their potential for affecting slope instability. The office review typically precedes a field review whose objectives include assessing the accuracy, limitations, and uncertainties of remotely sensed information and previously prepared materials, as well as adjusting any preliminary interpretations of landform features based on these data sources. The qualified expert determines the appropriate combination of assembled information based on the project objectives, requirements, and desired level of confidence in assessment products.

#### *Outcome.*

The office review typically precedes a field review by either a general practitioner or a qualified expert, especially where potentially unstable slopes and landforms are identified and require verification. Interpretations based solely on remote sensing data should not be used as substitutes for site-specific field assessments. If the expert determines from the office review that potentially unstable slopes or landforms are likely present, the landowner may exclude these areas from the proposed forest operations. Reports or information provided to DNR should include relevant results of the qualified expert's office review findings.

#### 5.1.3 Remote Sensing Tools Available for Office Reviews

Common sources of remotely sensed information used in identifying, delineating, and interpreting landforms are grouped broadly in two categories: (1) aircraft- or satellite-based earth imagery and photogrammetry; and (2) LiDAR and high-resolution topographic data. Previously prepared materials or documents often incorporate field and remotely-sensed data. These sources include maps and surveys, physical databases, technical reports, and other published and unpublished literature. Among the available remote sensing technologies, LiDAR has proven to be a valuable source of topographic data with distinct advantages over traditional analytical methods (e.g., aerial photo interpretation) for mapping landslides and interpreting landform characteristics (see Figure 23).<sup>35</sup> However, LiDAR is not a panacea; rather it complements traditional aerial photo interpretation and the analysis of both information sources are useful. Aside from the information provided in 5.1.4, see Appendix E for more information about LiDAR processing, applications, and data sources.

#### 5.1.4 LiDAR Use in Identifying Potentially Unstable Landforms

Hillshade, contour, and slope class maps derived from bare earth LiDAR digital elevation models (DEMs) are common LiDAR products used to identify landforms and landslides. A hillshade map is created by simulating sunlight shining on the topographic surface at a specified angle. A slope map shows the magnitude of the topographic gradient estimated by differencing the elevations of adjacent points in the DEM. Hillshade maps tend to have less contrast on slopes facing the incident

---

<sup>35</sup> e.g., Haugerud et al. 2003; Burns and Madin 2009; Roering et al. 2013; Tarolli 2014.

sun angle and more contrast on slopes facing away from the incident sun angle, either of which can obscure topographic features. Analyzing several hillshade maps generated with different sun angles or employing methods such as those described in Burns and Madin (2009) may minimize illumination and topographic shadowing effects (i.e., multi-directional oblique-weighted hillshade algorithm). Additional maps such as topographic curvature, surface roughness, and elevation contours can also be useful to identify deep-seated landslide features. Contours should be generated with spacing similar to the LiDAR data resolution and/or the scale of the geomorphic features of interest.

LiDAR-derived maps can reveal key topographic features indicating potential instability (e.g., visual indicators listed in 4.5) that are not always identifiable using other remote sensing data. Hummocky topography, benched surfaces, tension cracks, scarps, horst and graben features, pressure or transverse ridges, and irregular drainage patterns (Figures 25 and 26) are often visible, but only when the scale of the feature is larger than the resolution of the LiDAR data. The difference in screening for and depicting potentially unstable features between high and low-resolution LiDAR data can be seen in Figure 23. In Figure 23f, a hillshade map derived from 3-foot LiDAR data allows the user to approximately delineate the landslide's main scarp, body, and toe, whereas such features may not be recognized using lower resolution quality (i.e., 30-meter resolution).



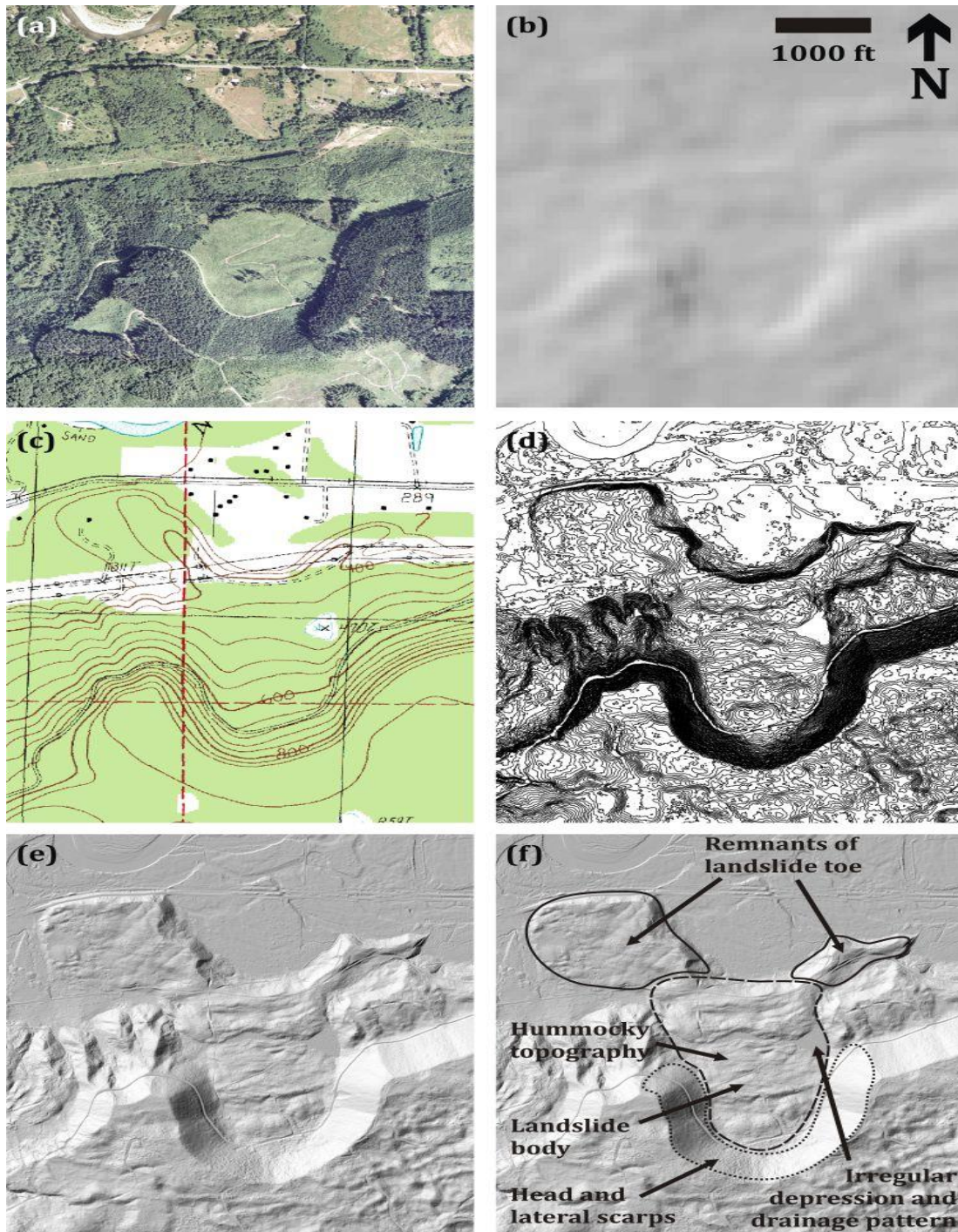
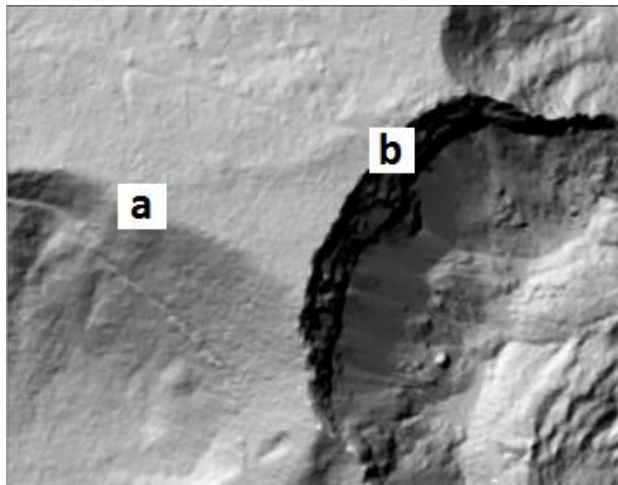


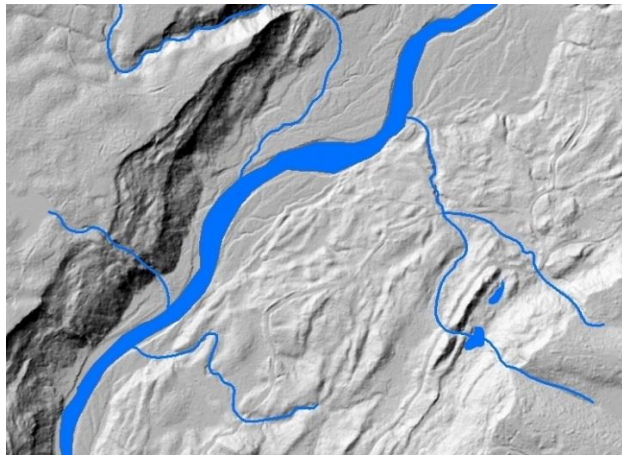
Figure 23. Example of a dormant glacial deep-seated landslide as seen in different types of remotely sensed data and with varying resolution quality:  
 (a) Digital Orthophoto Quadrangle, (b) hillshade map derived from 30-meter resolution ASTER Global Digital Elevation Model, (c) topographic map, (d) 6-foot contour map derived from 3-foot resolution airborne LiDAR, (e) hillshade map derived from 3-foot resolution airborne LiDAR, and (f) an annotated version of (e) (Adam Booth, Portland State University 2014).

LiDAR hillshades can be used to delineate and interpret deep-seated and, with less certainty, shallow landslides, although some depositional surfaces (for example debris fans) can be identified. Various measures of surface roughness are commonly used to recognize and quantify deep-seated landslide morphology in landslide mapping studies.<sup>36</sup> Recent regional examples of deep-seated landslide mapping that used LiDAR-based protocols include Burns and Madin (2009), Schulz (2005 and 2007), and Haugerud (2014).

LiDAR-based comparisons of landslide features are useful to ascertain relative age because younger scarp features generally produce a sharper image on high-resolution topography (i.e., 2-meter pixels) than older, more eroded features that are less clear (Figure 24). It is important to consider DEM raster resolution to avoid misrepresenting landslide age from lower-resolution images. Visual inspection of LiDAR imagery is also useful for change detection to ascertain evidence of movement prior to and after an event<sup>37</sup>.



*Figure 24. LiDAR image comparison between two deep-seated landslide scarps with the same resolution showing (a) subdued topography and (b) crisp topography. The less defined topography (a) suggests a greater relative age (DNR 2016).*



*Figure 25. Large slump feature showing displaced (deflected) streams within the landslide mass and sag ponds impounded by ridges (DNR 2016).*

<sup>36</sup> McKean and Roering 2004; Glenn et al. 2006; Booth et al. 2009; Berti et al. 2013.

<sup>37</sup> Iverson et al. 2015.

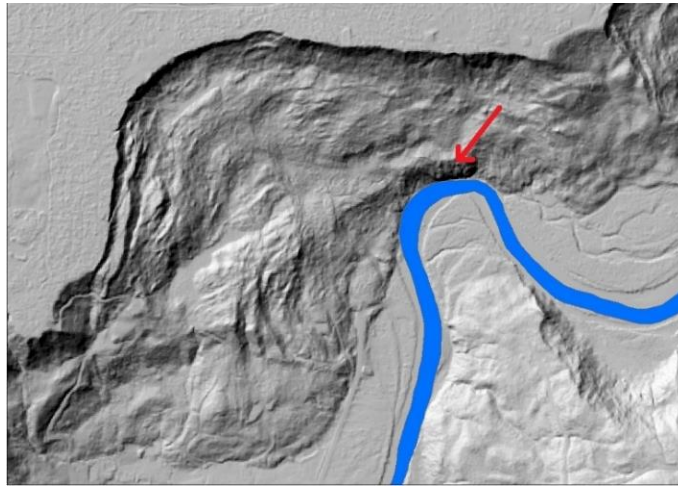


Figure 26. LiDAR image showing channel incision within a large deep-seated slump feature in the Tolt River valley, King County (DNR 2016).

## 5.2 Field Assessment

The purpose of the field assessment is to confirm the findings of the office review, and to identify unstable and potentially unstable landforms not recognized during the office review. While the office review can provide important information and a starting point, on-site observation of surface indicators is essential for identifying potentially unstable landforms.

### 5.2.1 General Practitioner’s Field Assessment

The objective of the general practitioner’s field assessment is to determine the presence or absence of the rule-identified landforms described in Part 4 and survey the area for any landforms missed in the office review. This assessment can typically be conducted during the reconnaissance and lay out of proposed forest practices activities (e.g., marking unit boundaries, establishing riparian management zones, laying out road systems). When the field assessment indicates that complex geological features are present or the scenario is beyond the general practitioner’s expertise, the landowner may ask a qualified expert to complete a further assessment. The practitioner should refer to 4.5 for indicators of slope instability and 5.3.2 for field review of groundwater recharge systems.

#### *Outcomes.*

Common results of the general practitioner’s field assessment are one of the following:

- The general practitioner does not identify any potentially unstable slopes or landforms within or around the planned area for the forest practices activities.
  - The landowner documents the finding in the slope stability sections of the FPA.
- The general practitioner identifies potentially unstable slopes or landforms in or around the planned operations area, and the landowner avoids timber harvest or construction on them.
  - The landowner documents the finding in the slope stability sections of the FPA, along with any additional required information that DNR may have requested.
- The general practitioner identifies potentially unstable slopes or landforms in or around the planned operations area, and the landowner proposes timber harvest or construction activities on them.

- The landowner retains a qualified expert to conduct geologic office and field reviews, and prepare a geotechnical report (see 7.2 for information required in a geotechnical report).<sup>38</sup> The landowner documents the finding in the slope stability sections of the FPA, along with the geotechnical report prepared by the qualified expert.

### 5.2.2 Qualified Expert's Field Assessment

When an investigation by a qualified expert is necessary, the objectives of the field assessment are to verify the presence or absence of potentially unstable slopes and landforms identified during office reviews and identify landforms previously undetected due to insufficient remote sensing data coverage or resolution. To meet the objectives, the qualified expert should collect sufficient information to describe the landforms in or around the site and may:

1. Refine any preliminary maps constructed during office reviews, including features not detected in the office review;
2. Assess failure mechanisms and the likelihood that the proposed forest practices will cause movement on, or contribute to further movement of potentially unstable slopes or landforms;
3. Analyze cause-effect relationships relative to the proposed activity;
4. Assess the likelihood of delivery of sediment or debris to public resources or threats to public safety;
5. Determine any possible mitigation for the identified hazards and risks;
6. Evaluate levels of confidence in office and field findings; and
7. Produce geologic information when requested or write a geotechnical report when required summarizing review findings, conclusions, and recommendations (see 7.2 for guidance on preparing in a geotechnical report).

#### *Summary of Procedures.*

The qualified expert determines the nature of the field review required to meet the objectives stated above. The field work can take one or more days and may involve an interdisciplinary team meeting if required by DNR. Depending on the analyst's level of confidence in potentially unstable landform identifications, delineations, and interpretations for any given site, the field assessment might range from qualitative to quantitative in nature.

An example of a qualitative assessment would include visual observations and photos of geological features and other site indicators at identified locations (e.g., GPS waypoints), which are summarized in a geotechnical report to substantiate landform and process interpretations. A more quantitative investigation could include such data collection techniques as topographic surveying for measuring landslide surfaces (i.e., that needed for slope stability modeling), soil sampling to test material properties, and subsurface sampling that could be important in analyzing the depths, materials, and hydrology of deep-seated landslides.

Preparation of a site-specific geomorphic map is helpful because most published geologic maps, although useful for understanding and locating bedrock and Quaternary sediment deposits, are insufficient to identify small-scale landforms that could have a significant effect on the proposed activity. In addition, some geologic information may not have been field verified or developed with high-resolution LiDAR. The purpose of mapping is to capture surface conditions, provide a basis

---

<sup>38</sup> The Department of Natural Resources' Forest Practices Division maintains a qualified experts list that can be viewed online at [http://www.dnr.wa.gov/Publications/fp\\_geo\\_experts.pdf](http://www.dnr.wa.gov/Publications/fp_geo_experts.pdf).

for the interpretation of subsurface conditions, and prepare more site-specific descriptions of relevant features.

A geomorphic map ideally includes the location, elevation, and attitude of known geologic contacts and relevant landforms, although such data collection is not feasible or necessary in all situations. In glacial materials, particular emphasis should be placed on the contact between high permeability soils and underlying low permeability soils or bedrock and the location of groundwater seeps or springs, especially where deep-seated landslide activity is suspected or encountered. The location of pertinent geologic components and potentially unstable indicators should be identified on the map or in the geotechnical report. Ideally, mapped products should be prepared on a scale of 1:12,000 or less using high-resolution LiDAR-generated topography, aerial photos, and field data. If high-resolution LiDAR is not available, base maps can consist of U.S. Geological Survey 7.5-minute topographic maps, DNR forest practices activity maps, or aerial photographs.

Geologic field data collection, analysis, and map compilation are undergoing a revolution in methods largely precipitated by GPS and GIS-equipped mobile computers.<sup>39</sup> To facilitate a review of the proposal, geologic reports containing GPS locations of landforms and other relevant features will assist locating such sites in the field. It is also helpful to include photographs of significant landforms or their components if the spatial scales are compatible with ground-based photography. It is important to note indicators of potential slope instability or active movement during the field review. These include topographic, hydrologic, and vegetative indicators described in 4.5.

#### *Outcomes.*

Each site contains a unique set of slopes and landforms and will require a distinct set of possible management strategies. In some cases, the qualified expert may recommend avoidance of a rule-identified landform, setbacks to a feature, or specific mitigation measures to lessen impacts to a landform. Results of a qualified expert's field assessment may include one of the following:

- The finding that areas of concern identified in the preliminary office review and field assessment do not meet the definitions of the rule-identified landforms (Part 4).
  - The qualified expert reports these findings to the landowner; the landowner documents the findings in the slope stability sections of the FPA.
- The finding that potentially unstable slopes or landforms in or around the operations area have minimal potential to deliver sediment or debris to a public resource or threaten public safety.
  - The qualified expert reports these findings to the landowner; the landowner documents the findings in the slope stability sections of the FPA.
- The finding that potentially unstable slopes or landforms within or, when appropriate, around the operations area have the potential to deliver sediment or debris to a public resource or threaten public safety.
  - The qualified expert prepares information listed in WAC 222-10-030(1) in a geotechnical report. In most cases, this scenario would fall under a Class IV-special definition in WAC 222-16-050(1) and require the landowner to submit a SEPA checklist or Environmental Impact Statement. The landowner documents the findings in the slope stability sections of the FPA and includes the report with the FPA.

---

<sup>39</sup> Whitmeyer et.al 2010; U.S. Geological Survey 2008; Edmondo 2002.

### 5.3 Delineating Groundwater Recharge Areas for Glacial Deep-Seated Landslides

As explained in Part 4, the groundwater recharge area for a glacial deep-seated landslide is a rule-identified landform. This landform is the area up-gradient of a landslide that can contribute water to the landslide. When timber harvest or construction activities are proposed on or around a verified glacial deep-seated landslide or its associated groundwater recharge area, a landslide activity assessment needs to be performed (see 6.1), including whether a groundwater recharge area exists, and if so, determining its spatial extent. DNR requires that a qualified expert make the final determination about the existence and boundaries of a groundwater recharge area for a glacial deep-seated landslide. However, a general practitioner may have a role in office reviews and field work under the direction of the qualified expert.

Typically, once a landslide has been mapped, an initial designation of the topographic groundwater recharge area is a straightforward task that can be performed on a detailed topographic map of the area. The most accurate tool available for mapping surface topography is high resolution DEM generated from LiDAR. Figure 27a shows the approximate groundwater recharge area for a landslide based on upslope topographical delineation. The cross section shown in Figure 27b illustrates the approximate stratigraphy through the groundwater recharge area and landslide body. The recharge, occurrence, and movement of groundwater through water-bearing units (aquifers), and confining units that inhibit groundwater movement, can have an effect on slope stability.

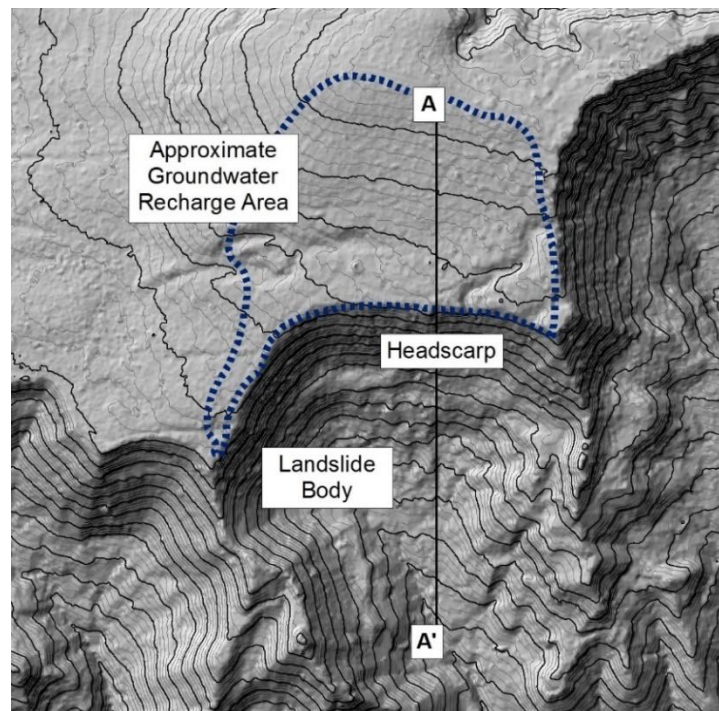


Figure 27a. Glacial deep-seated landslide. The dash-lined polygon is an approximate delineation of a groundwater recharge area based on LiDAR data (DNR 2014).

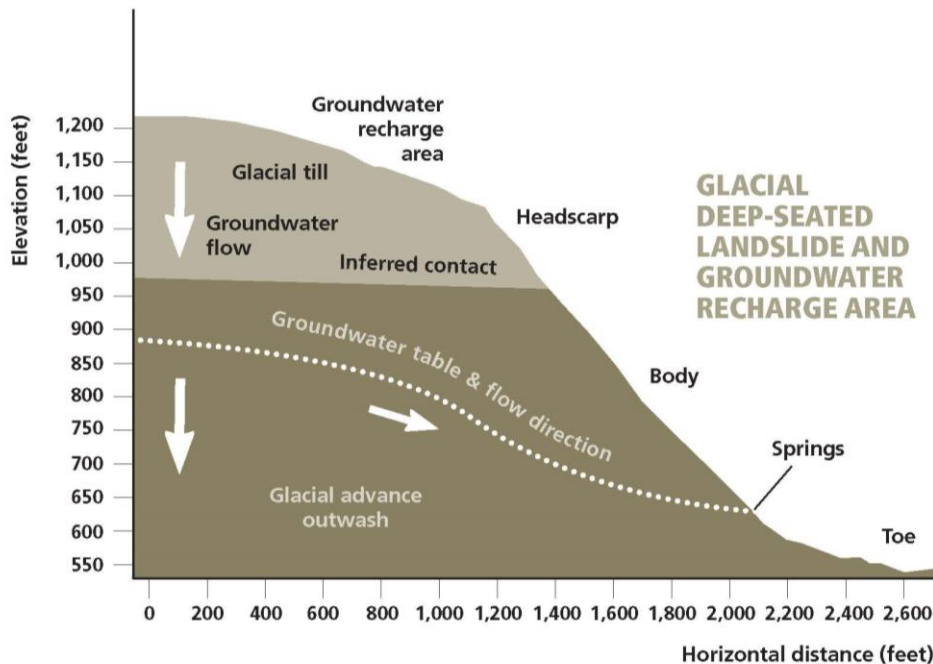


Figure 27b. Hillslope cross-section (A-A' in figure 27a) derived from 2-meter DEM of a glacial deep-seated landslide showing the groundwater recharge area, geologic units, and generalized groundwater flow paths (DNR 2016).

The recommended first step in delineating the groundwater recharge area is to evaluate its stratigraphic and/or topographic relationship to the landslide. Further investigations and analyses may be necessary when uncertainties remain as to the accuracy of the recharge area boundary. DNR uses the results of these analyses provided by qualified experts in geotechnical reports to determine FPA classifications and other decisions based on applicants' proposed activities.

### 5.3.1 Office Review for Groundwater Recharge Areas

The office review should include an assessment of the surrounding topography, land cover and vegetation, soils, and the distribution of hydrogeologic units. Groundwater movement from areas of recharge to discharge may vary over several orders of magnitude, depending on the hydraulic characteristics of the hydrogeologic units, which include water-bearing and non-water-bearing rocks and sediments (aquifers) and confining units, respectively.

In a simplified hydrogeologic setting in a humid environment, the groundwater table forms a subdued replica of surface topography with groundwater flow from higher altitude areas of recharge to lower altitude areas of discharge.<sup>40</sup> The surficial contributing area may be delineated from digital elevation models (DEMs) derived from LiDAR, or U.S. Geological Survey topographic quadrangles. Topography developed from high-resolution LiDAR is the most accurate tool available for mapping surface topography. This analysis provides an approximation of the potential area of recharge, but may not be valid in heterogeneous rocks and sediments with complex topography, depositional history, or deformational environments.

<sup>40</sup> Freeze and Cherry 1979.

The land cover of the recharge area can influence the magnitude of groundwater recharge. Vegetation type and distribution effect the amount of precipitation intercepted by foliage and leaf litter and the resultant through-flow that is available for recharge. In addition, land development and agricultural uses may influence groundwater recharge.

The reviewer may also find the following resources useful in the office review:

- Land cover data available nationally at a spatial resolution of 30 meters from the U.S. Geological Survey's (USGS) National Land Cover Database;
- Geologic maps for providing a basis for delineating the areal extent, orientation, and stratigraphic relationships of rocks and sediments that influence the occurrence and movement of groundwater. The USGS, DNR, and others have published geologic maps at scales of at least 1:100,000 across Washington and locally at larger scales (1:24,000).
- Well logs and geotechnical borings may supplement geologic mapping by revealing the vertical extent of rocks and sediments and providing information about grain size distributions, sorting, and other physical properties that may influence the hydraulic characteristics of hydrogeologic units. Department of Ecology maintains a searchable database of well logs for Washington State; however, subsurface data will generally be confined to developed areas.
- Hydrogeologic frameworks, which define the groundwater recharge environment and the subsurface environment in which groundwater occurs, have been developed from mapped geologic units, driller's logs, and hydrologic data at regional scales such as Puget Sound<sup>41</sup> and the Columbia Plateau<sup>42</sup>. However, it is also important to understand groundwater movement at smaller local scales. Hydrogeologic reports are available from sources such as the USGS and the Department of Ecology.

### 5.3.2 Field Assessment for Groundwater Recharge Areas

Groundwater recharge areas may occupy a range of hillslope gradients, shapes, and soil and rock types. Therefore, it is necessary to conduct a field inspection to determine if the initial designation accurately reflects the recharge area topography, including the topography up-gradient of the landslide. It is helpful to collect GPS waypoints along the topographic boundaries of the groundwater recharge area for mapping and revisiting the site if necessary. The field inspection should include:

- Examining the characteristics of the surface materials within the initially delineated groundwater recharge area, and documenting whether the soil types and subsurface geologic units are consistent with maps examined during the office review. In some cases, published soil and geologic data in forested areas may be inaccurate at the scale of an FPA activity map.
- Mapping the stratigraphic units that compose the hillslope (i.e., the distribution of geologic units or horizons below the groundwater recharge area) in order to describe the likely flow paths that could potentially connect the groundwater recharge area with the failure plane of the landslide. Landslide failure planes are often co-incident with subsurface aquitards such as silt or clay beds that form elevated groundwater tables within hillslopes. Understanding the morphology and orientation of these aquitards can help inform the spatial extent of the groundwater recharge area beyond the surface topographic expression of the hillslope up-gradient of a landslide. Subsurface investigations may be needed to adequately determine geologic units where mapping cannot be accurately accomplished by surface data alone.

---

<sup>41</sup> Vacarro et al. 1998.

<sup>42</sup> Bauer and Hansen 2000.



- Examining observable strata in exposures along marginal streams on the edges of the groundwater recharge area, or in head scarps of the landslide. The distribution of geologic units with increasing depth below the surface may also be available from well driller's logs or other subsurface information such as geologic maps and reports.
- Mapping and evaluating infrastructure such as road construction and landings with respect to relative water volumes flowing to or from a landslide or groundwater recharge area.
- Identifying surface water and stream drainages on or adjacent to deep-seated landslides and assessing the potential of water flowing to or away from a landslide and recharge area.

Although rarely applied in the forested environment, excavating test pits, driving soil probes, drilling monitoring wells, or using geophysical techniques such as seismic or electric resistivity methods can better characterize and reduce uncertainties about subsurface groundwater conditions where topographic indicators are inconclusive.

## **PART 6. ADDITIONAL ANALYSES FOR UNSTABLE SLOPES**

Part 5 provides guidance for office and field reviews appropriate for both general practitioners and qualified experts. The preliminary assessment of landslide risk, and the potential for forest practices to affect risk, has occurred during the office and field reviews. A proposed forest practice in or around a glacial deep-seated landslide and its associated groundwater recharge area may require the additional analyses discussed in Part 6. These analyses may also be useful for other situations, such as assessing the landslide activity level of a bedrock deep-seated landslide or calculating the slope stability and failure potential of an individual unstable hillslope where a forest practice is proposed. The qualified expert identifies which analyses are needed on a site-by-site basis.

Part 6 provides guidance on:

- Deep-Seated Landslide Activity Assessment (6.1);
- Glacial Deep-Seated Landslide Assessment (6.1.1);
- Quantitative Field Assessment Methods for the Qualified Expert's Subsurface Investigations (6.2);
- Water Budget and Hydrologic Contribution to Glacial Deep-Seated Landslides (6.3);
- Computational Slope Stability Assessment Methods (6.4); and
- Runout and Delivery Assessment (6.5).

### 6.1 Deep-Seated Landslide Activity Assessment

A landslide activity assessment is an important component of evaluating potential landslide hazard and risk. Assessing past geomorphologic features and current landslide conditions can contribute to a qualified expert's geologic evaluation. The three components of landslide activity for evaluation during the office and field review process are the state of activity, the distribution of activity, and the style of activity.<sup>43</sup>

The *state of activity* refers to the timing of landslide movements and ranges from active (current or recent movement) to dormant (has not moved in recent decades or centuries) to relict (clearly developed in the geomorphic past under different conditions than currently present). If the conditions that contributed to prior movement are still present even though the landslide is dormant, it may become reactivated at a later time. The landslide may be considered stabilized if the

---

<sup>43</sup> Cruden and Varnes 1996.

conditions promoting failure have naturally changed to promote stability or if human intervention has protected against future movement.

Interpretation of vegetation cover, surface morphology, and toe modification by a stream all aid in determining the state of activity based on local knowledge of typical rates of biologic and geomorphic processes.<sup>44</sup> The characteristics described by Keaton and DeGraff (1996) have been successfully applied in the Pacific Northwest. A modified version is presented in Table 2. New vegetation generally begins to colonize a landslide’s scarp, lateral flanks, or other areas of disturbed ground once the landslide becomes dormant and progresses to mature vegetation cover. The scarp, flanks, and internal hummocky morphology of the landslide also tend to become increasingly subdued with time after the landslide becomes dormant, and the internal drainage network of the landslides tends to become more connected and organized. If the toe of the landslide enters a stream, that stream progressively modifies the toe as recorded by terraces and the establishment of a floodplain comparable to reaches unaffected by landslide activity.

The *distribution of activity* refers to the geometry and spatial patterns of landslide movements and how these patterns may change with time. One key distinction is if the landslide is advancing by extending downslope in the main direction of movement, or head cutting by extending in the upslope direction. A landslide can also widen or narrow in the direction perpendicular to movement, and can enlarge or diminish if its total volume is increasing or decreasing.

The *style of landslide activity* refers to the type of movement as shown in Table 1, Landslide Classification. Landslides may also occur as complex failures encompassing more than one type of movement. Deep-seated landslides may reactivate or develop successive or secondary landslides over time as compound failures.

Table 2. Guidelines for estimating deep-seated landslide activity level based on vegetation and morphology  
(modified from Keaton and DeGraff 1996)

Active State	Main Scarp	Lateral Flanks	Internal Morphology	Vegetation+	Toes Relationships
Active/recent*	Sharp; unvegetated	Sharp; unvegetated streams at edge	Undrained depressions; hummocky topography; angular blocks separated by scarps	Absent or sparse on lateral and internal scarps; trees tilted and/or bent	Main valley Stream pushed by landslide; floodplain covered by debris; lake may be present
Dormant-distinct	Sharp; partly vegetated	Sharp; partly vegetated; small tributaries to lateral streams	Undrained and drained depressions; hummocky topography; internal cracks vegetated	Younger or different type or density than adjacent terrain; older tree trunks may be bent	Same as for active class but toe may be modified by modern stream

<sup>44</sup> Keaton and DeGraff 1996, Table 2.

Dormant-indistinct	Smooth; vegetated	Smooth; vegetated; tributaries extend onto body of slide	Smooth, rolling topography; disturbed internal drainage network	Different type or density than adjacent terrain by same age	Terraces covered by slides debris; modern stream not constricted but wider upstream floodplain
Relict	Dissected; vegetated	Vague lateral margins; no lateral drainage	Smooth, undulating topography; normal stream pattern	Same age, type, and density as adjacent terrain	Terraces cut into slide debris; uniform modern floodplain
<p>*Recent is defined as being within the photo history or within the period of forest management.</p> <p>+Vegetative indicators are forest vegetation and not grasses, forbs, or shrubs. It is important to note that in most areas of western Washington, landslide scars re-vegetate within 15 years and may be difficult to detect from aerial photographs 10 to 15 years after the slide occurred.</p>					

### 6.1.1 Glacial Deep-Seated Landslide Assessment

Following on the information in Part 6.1, below is a list of basic steps appropriate for a landslide activity assessment of a glacial deep-seated landslide and its associated groundwater recharge area. The steps provide a guide for assessing the risk associated with a particular landslide based on the level of landslide activity and how likely the landslide is to deliver sediment to public resources. Working through steps 1 through 3 will help the qualified expert determine if the next step should be 4, 5, or 6. Where it is appropriate to follow step 4, 5, or 6, step 7 may need to be accomplished as well.

1. Identify and map the glacial deep-seated landslide and associated groundwater recharge area.
2. Classify landslide activity using the protocol (modified from Keaton and DeGraff 1996) for deep-seated landslides as:
  - active;
  - dormant/distinct;
  - dormant/indistinct; or
  - relict.
3. Evaluate delivery potential if the landslide were to move for:
  - public safety (e.g., houses and public roads); and
  - public resources (water, fish, wildlife, and capital improvements).
4. If the landslide is relict or dormant/indistinct, and the potential for reactivation of any portion of the landslide by harvest within the groundwater recharge area is highly unlikely, then additional analysis may not be necessary. Documentation of this analysis may be provided by a letter, memo, or other appropriate form.
5. If the landslide is active/recent or dormant/distinct with a low delivery potential, perform a qualitative assessment of factors contributing to landslide movement including natural disturbance, channel influences, and historic patterns of timber harvesting within the groundwater recharge area.
6. If the landslide is active/recent or dormant/distinct and has moderate or high delivery potential, in addition to a qualitative assessment, the qualified expert may consider additional analyses such

as assessing whether a potential increase in groundwater recharge from timber harvest will affect the stability of the landslide.

7. Design appropriate landslide mitigation measures commensurate with delivery potential and hazard.

### 6.2 Quantitative Field Assessment Methods for the Qualified Expert's Subsurface Investigations

Subsurface investigations can be necessary for assessing proposed forest practices activities where more detailed information on landslide geometries, soil properties, or groundwater conditions is needed. They can be designed to gather data necessary to evaluate the landslide in accordance with the evapotranspiration, recharge, groundwater flow, and slope stability modeling.

The selection of exploration methods should be based on the study objectives, size of the landslide area, geologic and hydrogeologic conditions, surface conditions and site access, limitations of budget and time, and risk potential.<sup>45</sup> A qualified expert should supervise the subsurface investigation so that the field activities are properly executed and the desired results can be achieved. Subsurface exploration to assess landslides is generally described by McGuffey et al. (1996) and summarized in the following paragraphs.

*Test Pits.* Shallow test pits can be dug by hand with a shovel. Backhoes or track excavators can advance test pits to depths of up to 20 feet in certain soils. They are useful for exposing subsurface soil and rock conditions for purposes of mapping or logging the underlying conditions, and identifying shallow groundwater elevations and failure planes.

*Hand Auger.* A hand auger can be used to identify soil types to depths up to nearly 20 feet (in loose soils) but does not provide significant information regarding soil material properties.

*Drive Probe.* A simple hand probe can be used to estimate soil density and the depth to dense soil. The Williamson Drive Probe (WDP)<sup>46</sup> was developed as an inexpensive and portable alternative to other more expensive and less portable methods for determining soil relative densities and groundwater table elevations. Sections of hardware pipe are coupled and driven into the ground manually with a sliding hammer. The number of blows, in even distance increments, required to drive the probe is used to describe soil conditions. Blow-count data has been empirically correlated with the Standard Penetration Test (American Society for Testing and Materials 2014).<sup>47</sup> Limitations include manual labor intensity, which can limit the number of holes drilled in a given day. The WDP can also be used to estimate depth to groundwater if perforated pipe is used..

*Drill Rigs.* Borings constitute a method for collecting geotechnical data. Access limitations can be addressed if logging roads are fortuitously located, or by using track-mounted equipment. In some cases, undisturbed or lightly disturbed soil samples can be collected for quantitative laboratory testing (i.e., direct shear, bulk density, moisture content, etc.). For long-term monitoring, a drill rig can also be used to install groundwater monitoring wells that contain pressure transducers, and as a conduit for geotechnical instrumentation (i.e., inclinometer, extensometer, etc.).

---

<sup>45</sup> McGuffey et al. 1996.

<sup>46</sup> Williamson 1994.

<sup>47</sup> Adams et al. 2007.

*Geophysical Methods.* Surface-based geophysical methods are used to collect general subsurface information over large areas of rugged terrain. These include ground penetrating radar, electromagnetic, resistivity, and seismic refraction methods. These techniques can provide information on the location of boundaries between coarse-grained and fine-grained strata and the depth to the water table.

### 6.3 Water Budget and Hydrologic Contribution to Glacial Deep-Seated Landslides

The water budget of a groundwater/surface-water system describes the input, movement, storage, and output of water from a hydrologic system. Water enters a hydrogeologic system through precipitation in the form of rainfall, snowmelt, and other confined or unconfined groundwater sources. Not all precipitation, however, becomes groundwater; some is intercepted by vegetation or surface duff and debris and evaporates before reaching the ground or sublimates from the snowpack (see 6.3.1). Water that reaches the ground may run off directly as surface flow or shallow near-surface runoff, infiltrate or evaporate from the soil, or transpire through vegetation foliage. Water that percolates below the root zone and reaches the water table is considered to be groundwater recharge. Groundwater moves from areas of high hydraulic head to areas of low hydraulic head where it leaves groundwater flow through wells, springs, streams, wetlands, and other points of groundwater discharge. The occurrence and movement of groundwater through the subsurface depends on the hydraulic properties of subsurface material as well as the distribution of groundwater recharge.

Further assessments for evaluating the influence of water to a glacial deep-seated landslide may be necessary when preliminary assessments suggest that the proposed forest practices activity increases the potential for contributing to movement of unstable landforms. The extent of the analysis depends on site-specific geological and hydrogeological conditions. The following discussions of evapotranspiration and groundwater flow may be useful to the qualified expert.

#### 6.3.1 Modeling Evapotranspiration

Modeling evapotranspiration is a data intensive exercise that requires regional and/or site-specific information regarding precipitation types and rates, wind speed, relative humidity, temperature, solar energy, and plant community stand characteristics.<sup>48</sup> The goal of evapotranspiration modeling is to derive estimates of the potential increase in water available to the groundwater recharge area from changes in energy balances, wind speeds, and plant community characteristics (i.e., aerodynamic roughness) after forest harvest.

Effects of evapotranspiration on the soil water budget can be partitioned as follows: (1) canopy interception of rainfall or snow and subsequent evaporation loss to the atmosphere; (2) transpiration of infiltrated water to meet the physiological demands of vegetation; and (3) evaporation from the soil or litter surface. The various vegetation covers provide for varying balances of these fundamental water loss processes. The effects of evaporation on soil water budgets are relatively small compared to canopy evapotranspiration and interception.<sup>49</sup>

Transpiration is the dominant process by which soil moisture in densely vegetated terrain is converted to water vapor. Transpiration involves the adsorption of soil water by plant roots, the translocation of the water through the plant and release of water vapor through stomatal openings in

---

<sup>48</sup> Jassal et al. 2009.

<sup>49</sup> Bosch and Hewlett 1982.

the foliage. Transpiration rates depend on availability of solar energy and soil moisture as well as vegetation characteristics, including vegetation type (e.g., conifer or deciduous), stand density, height and age, rooting depth, leaf area index, leaf conductance, albedo of the foliage, and canopy structure. Rates of transpiration are similar for different vegetation types if water is freely available.<sup>50</sup>

Transpiration is typically quantified using Soil-Vegetation-Atmosphere Transfer (SVAT) models where the movement of water from the soil through the plant to the atmosphere is represented by several resistances in series: (1) the integrated soil-root system; (2) the stem; (3) the branch; and (4) the effective stomatal resistance. Eddy correlation techniques are commonly used to estimate transpiration fluxes.<sup>51</sup>

Interception by vegetation cover controls both the amount and timing of precipitation reaching the soil surface. The interception capacity of vegetation types is important because intercepted water has a high surface area to volume ratio that promotes efficient evaporation by convection. Intercepted rainfall is mostly stored on the surface of foliage and stems, while snowfall collects in the tree crowns facilitating an accumulation of snow over large surface areas of the canopy. Interception and subsequent evaporation of water from vegetation cover is particularly significant in coniferous forests<sup>52</sup>; snow or rain losses from these dense canopies can account for up to 50% of gross annual precipitation<sup>53</sup>. Moore and Wondzell (2005) estimated that interception loss in Pacific Northwest conifer forests ranged from 10% to 30%. Dingman (2002) reported similar values for Pacific Northwest plant communities, ranging from 21% to 35%, based on canopy characteristics and climate conditions. Hanell (2011) reported hydrologic modeling<sup>54</sup> that predicts a 27% decrease in evapotranspiration resulting from forest conversion to shrub for a site on the western Olympic Peninsula.

The proportion of rainfall intercepted by forest canopies is inversely related to both antecedent wetness and rainfall intensity. Gentle short-duration rainfall may be almost totally intercepted, while interception may account for as little as 5% of precipitation during intense winter storms.<sup>55</sup>

Approaches for estimating changes in evapotranspiration typically involve some combination of the Penman-Monteith model for calculating the canopy resistance, the Bowen ratio energy balance technique to estimate evaporation from plant surfaces, and the Priestly-Taylor formula to estimate evaporation from the soil surface. Reviews and demonstrations of these techniques are found in Avery and Fritschen 1971; Fritschen 1975; Ziemer 1979; Hanks and Ashcroft 1980; Campbell 1986; Simpson 2000; Martin et al. 1997; and Sias 2003.

### 6.3.2 Groundwater Recharge and Groundwater Flow Modeling

Groundwater recharge is difficult to measure directly, but several empirical and numerical methods exist for estimating recharge within unsaturated and saturated zones, including physical, tracer, and numerical-modeling techniques.<sup>56</sup> Recharge is commonly estimated by calculating the residual

---

<sup>50</sup> Campbell 1986.

<sup>51</sup> Hanks and Ashcroft 1980.

<sup>52</sup> Link et al. 2004.

<sup>53</sup> Dingman 1994.

<sup>54</sup> DHSVM; Wigmosta, Njssena and Stork 2002.

<sup>55</sup> Ramirez and Senarath 2000.

<sup>56</sup> Scanlon et al. 2002.

component of the water budget where recharge equals the difference between precipitation and the sum of losses through evapotranspiration, surface runoff, and shallow groundwater flow. The accuracy of recharge estimated through this method is limited by the large uncertainties inherent in the estimating components of the water budget such as evapotranspiration, which is typically large in magnitude relative to groundwater recharge. Examples of numerical models capable of estimating recharge based on a water budget include the Deep Percolation Model<sup>57</sup>, the Precipitation Runoff Modeling System<sup>58</sup>, and the Variable Infiltration Capacity Model<sup>59</sup>. Once the spatial distribution of groundwater recharge is estimated, the movement of groundwater within the subsurface may be modeled using groundwater flow models. The movement of groundwater from areas of recharge may be modeled using groundwater flow models such as MODFLOW.<sup>60</sup> Groundwater flow models are based on a hydrogeologic framework that incorporates the hydraulic properties of geologic materials and their stratigraphic relations. Groundwater models are calibrated using hydrologic data including groundwater levels within major water-bearing hydrogeologic units, and can be used to characterize the movement of groundwater from areas of recharge to areas of discharge.

#### 6.4 Computational Slope Stability Assessment Methods

Quantitative assessments of slope stability, performed by the qualified expert, may be necessary to characterize slope failure potential at a given site, and evaluate potential impacts of forest practices activities to public resources and public safety. This quantitative assessment may entail one or more methods. Limit equilibrium and numerical stability analyses may be used to evaluate the potential effects of increased groundwater recharge on glacial deep-seated landslides, but other methods may be necessary under certain conditions.

Limit-equilibrium analysis calculates a factor of safety for sliding along a critical failure surface, which is expressed as a ratio of the shear strength of the earthen material resisting slope failure to the shear stresses driving instability. Relative stability is defined by a factor of safety exceeding a value of one. A two-dimensional limit-equilibrium analysis method may be applied to deep-seated landslides but can also be useful for smaller local site situations. Computation of the most critical failure surface is an iterative process generally supported by commercially available or public domain software.<sup>61</sup> Field-developed cross sections, back calculation of soil strength parameters, and estimation of groundwater elevations can be done where field accessibility is limited using the methods of Williamson (1994).

Development of a two dimensional model for analysis requires the following information to define an initial state of stability:

- An engineering geologic section through the slope of concern (generally cut through the steepest portion of the slope) showing the thickness and position of each engineering geologic unit. The topographic surface profile can be field-surveyed or derived remotely from DEM topographic data whereas the subsurface failure plane geometry might need to be interpolated between known or hypothesized points (i.e., the locations at which the failure plane intersects the ground

---

<sup>57</sup> Bauer and Vaccaro 1987.

<sup>58</sup> Leavesley et al. 1983.

<sup>59</sup> Liang et al. 1994.

<sup>60</sup> Harbaugh et al. 2000.

<sup>61</sup> e.g., LISA, DLISA, STABL, SLOPE-W.

surface) in the absence of field data acquired from boreholes or with other geotechnical methods;

- Location and elevation of groundwater regimes along this critical section; and
- Saturated and unsaturated unit weights and shear strength of each engineering geologic unit.

The potential effects from the proposed forest practices activities on slope stability can then be evaluated by modifying the initial model with the expected condition based on the proposed activities, such as placement of fill for road construction or elevating groundwater levels (pressures) due to forest canopy removal. Limit-equilibrium models also allow the analyst to reconstruct pre-failure slope conditions of existing landslides by varying the input parameters (e.g., surface topography, engineering geologic unit properties, failure plane geometries, groundwater table elevations) such that the reconstructed original slope fails. These exercises are useful for evaluating reasonable strength parameters of subsurface materials, likely failure plane geometries, and groundwater table elevations in the absence of real data or field indications. Two-dimensional models can also be used to evaluate downslope material impacts to public resources and threats to public safety, as well as upslope impacts in situations where retrogressive failure mechanisms are suspected. Turner and Schuster (1996) and many other references provide more details on the process and methodologies for performing limit-equilibrium stability analyses, including method assumptions and limitations. All of the above steps require considerable engineering geologic/geotechnical data (e.g., subsurface, instrumentation, laboratory) and expertise to achieve an accurate and meaningful representation of the actual conditions at the site.

### **6.5 Runout and Delivery Assessment**

The forest practices rules apply where there is *potential* for sediment and debris to deliver to a public resource or threaten public safety. When forest practices are proposed on a rule-identified landform, the likelihood that sediment and debris would travel, or runout, far enough to threaten a public resource or public safety should be evaluated.

The following information is provided in 6.5:

- 6.5.1 provides an overview of the common landslide types associated with rule-identified landforms.
- 6.5.2 and 6.5.3 cover the factors to consider in a debris flow runout assessment. Shallow-rapid landslides are discussed because they are the single most common type of landslide and because extensive research about the factors influencing runout has been accomplished over the past three decades.
- 6.5.4 contains summaries of scientifically-derived methods for predicting shallow-rapid landslide deposition and runout distances. Predictive methods for calculating deep-seated landslide runout are not discussed because they are still under development by the scientific community.
- 6.5.5 provides a brief overview of the use of barrier trees for mitigating potential landslide delivery.
- 6.5.6. provides an overview on how LiDAR can be used to evaluate potential runout based on past deep-seated landslide deposits.

Runout and delivery distance, the total distance landslide debris is transported and deposited, depends on a combination of processes and topography. For example, debris flows are highly mobile and can move miles in steep confined channels. Deep-seated landslides can move anywhere



from a few feet to a few miles depending on the friction of the slip plane, the forces pulling the landslides down, and the shear strength resisting those forces.

Factors to consider in a runout and delivery assessment may include the following depending on the landform and landslide type:

- Initial failure volume of a landslide;
- Type of failure mechanism;
- Nature of the geologic material involved;
- Topographic features of potential runout paths;
- Historic landslide activity and runout characteristics in the area;
- Proximity to a public resource or safety concern; and
- For deep-seated landslides, observed deformation characteristics of nearby landslides with comparable geologic/geomorphic attributes.

Because each site has a unique set of geomorphic characteristics, it is not practical to provide prescriptive guidelines to predict delivery. An evaluation of deliverability will require a field assessment and professional judgment in landslide processes and mobility. However, professionals often rely on observed patterns and simple evaluations to determine whether an extensive delivery assessment and runout calculation is needed. For example, deposition generally will not continue where the channel becomes unconfined and transitions to a gradient of 6% or less. Also, historical deposits may reveal patterns. If a debris fan exists at the base of a confined channel, the extent of future deposition may predictably occur close to the existing debris fan. Or if many shallow-rapid landslides have occurred in the area, the deposition in that area will likely mimic that history.

To assess the potential for delivery and estimate runout distance, analysts can evaluate the history of landslide runout in the region, use field observations, and use appropriate geometric relationships from the scientific literature. Historical patterns can be evaluated by gathering aerial photos and landslide inventories. LiDAR data is valuable for mapping evidence of previous deep-seated and larger shallow-rapid landslide deposits, and identifying likely initiation points during initial investigations. Site visits can verify potential initiation points and depositional areas, and are useful for measuring previous landslide events.

In a situation where the potential for delivery is questionable, it is best to have a qualified expert examine the site and evaluate the likelihood of delivery. If forest practices are planned on a potentially unstable landform with questionable or obvious potential to affect a public resource or public safety, a geotechnical report written by a qualified expert is required.

#### 6.5.1 Landslide Types Associated with Rule-Identified Landforms

High hazard landforms and associated geomorphic criteria provide the basis for the rule-identified landforms (refer to Part 4 for more information on rule-identified landforms). Inherent in the assessment of rule-identified landform presence is the detection of these criteria as well as estimating landslide travel distance relative to the location of at-risk public resources or areas that could result in a risk to public safety. Once a potential rule-identified landform has been identified, considerations are made as to the type of landslide that might occur, the rate of movement, potential volume, flow properties, and the topography of runout paths (e.g., gradient, confinement) before delivery potential can be determined.

The type of landslide and travel distance that can occur is typically constrained by factors such as landform scale, soil depth, and topographic features within and below an unstable landform. For example, the width and depth of shallow landslides from bedrock hollows rarely exceed tens of meters, and failures typically occur at the soil-bedrock interface where soil depths are typically one meter or less.<sup>62</sup> Failures are commonly translational, move very rapidly, and accumulate additional materials significantly with travel distance unless they enter confined channels and continue to propagate as debris flows. Landslides that initiate within inner gorge landforms are predominantly shallow with rapid sediment delivery. Inner gorge landslide volumes tend to be relatively small compared to convergent headwall landslides, and they may not propagate down the receiving channel as debris flows. Conversely, active deep-seated earthflows may move less than a few feet per year. They can deliver sediment to streams, but rarely are considered a high public safety hazard due to the typically episodic and slow rate of movement. However, secondary failures along lateral stream channels and on deep-seated landslide toes may be subject to rapid debris flow initiations. Table 3 identifies common associations between rule-identified landforms, mass movement modes and rates, and composition and relative depth of the failed mass.

Table 3. Landslide types associated with rule-identified landforms.

<b>Rule-identified Landform</b>	<b>Typical mass movement mode(s)</b>	<b>Common landslide types</b>	<b>Material / Depth of failure</b>
Bedrock hollow	Translational and rapid	Debris slides and debris flows	Colluvial soil mantle / Shallow
Convergent headwall	Translational and rapid	Debris slides and debris flows	Colluvial soil mantle / Shallow
Inner gorge	Translational or rotational, rapid or slow	Debris slides, debris flows, debris avalanches, shallow or deep slumps	Colluvial soil mantle, residual soil mantle, bedrock outcrops; glacial, fluvial, and lacustrine deposits / Shallow
Deep-seated landslide toe	Rotational or translational, rapid or slow	Debris slides, debris flows, debris avalanches, deep-seated slumps, earth flows	Colluvium / Variable depths
Outer edges of meander bends	Translational and rapid	Debris slides, debris flows, debris avalanches, shallow or deep slumps	Colluvial soil mantle; glacial, fluvial, and lacustrine deposits / Shallow
Groundwater recharge areas associated with glacial deep-seated landslides	Rotational or translational, rapid or slow	Deep-seated slumps, debris flows, debris avalanches, earth flows	Glacial, fluvial, and lacustrine deposits / Variable depths

### 6.5.2 Factors Influencing Debris Flow Runout

Debris flow runout distances within valleys or inner gorges and across debris fans, have been studied by empirical observation in the Pacific Northwest.<sup>63</sup> It has been generally demonstrated that basin topography controls the flow types that reach a fan at the base of the hillslope, causing fan

<sup>62</sup> Dietrich et al. 2007

<sup>63</sup> e.g., Benda and Cundy 1990; Robison et al. 1999; May 2002; Guthrie et al. 2010.

gradient and the presence of various deposits to be somewhat predictable.<sup>64</sup> Predictive models based on simple height and gradient parameters have been developed, and several are described in 6.5.4.

There is considerable variability in the empirical observations. A debris flow may stop as a discrete deposit, debris fan, or sediment wedge above wood accumulations; or it may deposit gradually along a significant length of channel. In general, gradients are steep at initiation sites, remain steep where scour-to-bedrock occurs, and moderate in transport and deposition areas. Figure 28 is a generalized illustration of debris flow processes.

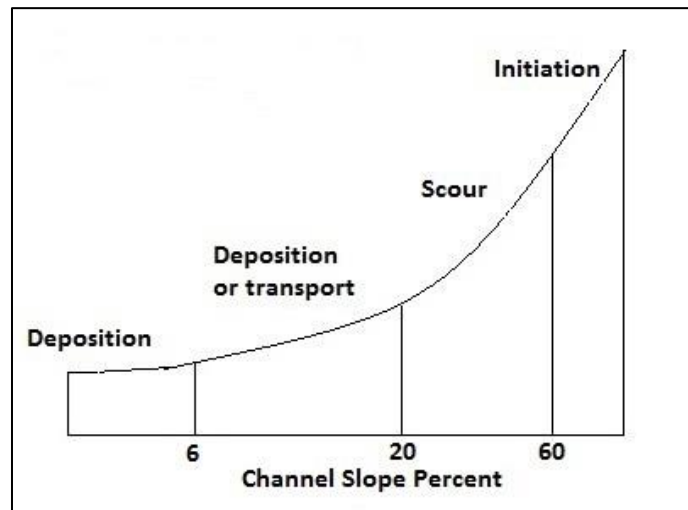


Figure 28. Debris flow characteristics relative to channel slope (adapted from Benda et al. 1998).

#### Initiation and Gradient

Initiation typically occurs on hillsides steeper than 70% but sometimes occurs on slopes as low as 60%.<sup>65</sup> When channel gradients drop below 20%, debris flows no longer cause significant scour and start to lose their momentum. On slopes gentler than about 5% to 7%, debris flows further slow and the solids entrained in them (rock, soil, and organic material) tend to settle out and deposit. Travel distance over a low-gradient surface is a function of the debris flow's volume and viscosity. The solid volume of a debris slide or flow deposit is a function of soil depth, distance traveled down the hillslope, and the gradient of the traveled path. The proportion of water is the main control on viscosity.

Many data sets show significant overlap in the gradient ranges of erosional and depositional behavior where erosion can occur at lower slope angles (approximately 3% to 10%) and deposition can occur at higher gradients (55% to 80%).<sup>66</sup> Figure 29 displays detailed field data that demonstrates both the real differences and the large overlap.<sup>67</sup> Two of the larger data sets show that net deposition generally occurs from 14% to 21%<sup>68</sup> and from 21% to 27%.<sup>69</sup> Guthrie et al. (2010) specifically conclude that, “[d]eposition and scour occur on steeper and flatter slopes, respectively,

<sup>64</sup> e.g., Melton 1965; Scheidl and Rickenmann 2010.

<sup>65</sup> Robison et al. 1999.

<sup>66</sup> e.g., May 2002; Guthrie et al. 2010.

<sup>67</sup> May 2002.

<sup>68</sup> Hungr et al. 1984.

<sup>69</sup> Guthrie et al. 2010.

than previously reported...”, in part because of the detailed field work they conducted. Benda and Cundy (1990) found that debris flows from their Oregon Coast Range study sites almost always stop within the confined channel network where the channel gradient drops below about 6% and where the tributary junction angle is greater than 70 degrees. They do note that the deposit typically continues 150 to 500 feet further downstream. A conservative approach would be to predict deposition only after 1000 feet of a channel with a gradient of less than 6%.

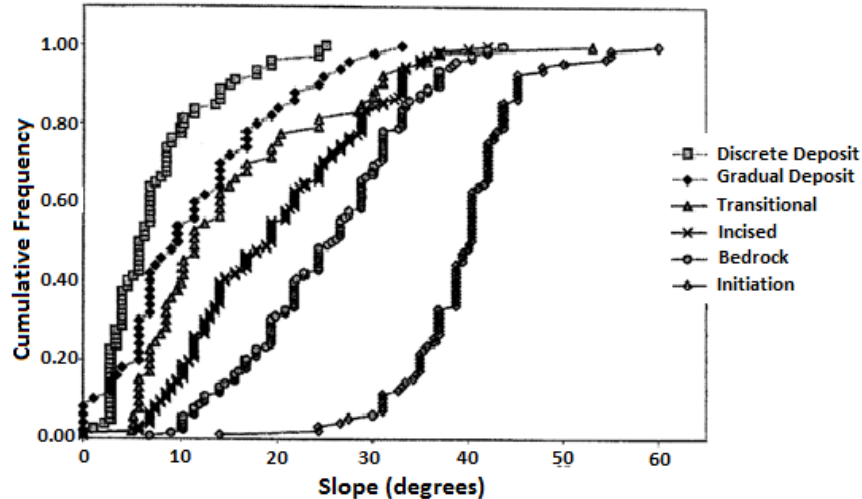


Figure 29. Slope distributions for depositional zones (discrete and gradual), transitional zones, erosional zones (incised and bedrock), and initiation sites for debris flows (from May 2002).

The overlap between erosional and depositional behavior within generally confined valley settings means that factors other than just channel gradient are influencing debris flow runouts. Several studies<sup>70</sup>, but not all<sup>71</sup>, find that runout length has been strongly correlated with event volume such that larger events travel further than smaller events.

#### Confinement

Channel confinement, the ratio of valley width to channel width, plays a role in debris flow runout. For example, Lancaster et al. (2003) and Benda and Cundy (1990) found that deposition may begin at higher channel gradients where confinement is low, while erosion may continue at lower channel gradients where confinement is high. Confinement alone appears to account for much of the overlap in gradient between erosional and depositional behavior, and in turn exerts influence on runout lengths. Additionally, Fannin and Rollerson (1993) demonstrated that a ratio of channel width to channel gradient delineated the zones of scour and deposition.

#### Saturation

Initial water content of the landslide mass and the amount of water in the receiving channel both influence landslide saturation. Saturation of the landslide and the resulting debris flow influences mobility, which is a function of landslide speed and travel distance. Considering that rain, snowmelt, or other water inputs trigger the majority of landslides in the Pacific Northwest, almost all landslides contain some amount of water that tends to mobilize the soil or rock. Debris slides that do not reach streams (i.e., do not absorb large volumes of additional water) usually deposit on

<sup>70</sup> e.g., May 2002; Sheidl and Rickmann 2010.

<sup>71</sup> Prochaska et al. 2008.

the hillslope and typically do not travel across large areas of flat ground. However, since most landslides occur during storm events, a large proportion of debris slides do reach flowing channels and create the opportunity to entrain enough water to become debris flows that can travel considerable distances in steep or moderate channels.

### *Lithology*

Lithology and its influence on soil development may affect runout distances. Qualified experts in Washington State have noted that debris fans are steep and short where local material includes large boulders, and that fine-grained silt loams may liquefy and flow across nearly level surfaces. Krogstad and O’Conner (1997) noted that relatively cohesion-less soils in the South Fork Skokomish produced long runout distances but had limited scour ability. However, the relationship between lithology and/or soil type and runout distance has not been systematically studied. Qualified experts are encouraged to conduct empirical studies (e.g., a landslide inventory with emphasis on runout and delivery) to better predict the probability of delivery and impact in a local area for an individual lithology.

### *Vegetation*

Runout distances are also influenced by standing forest vegetation along the runout path. Using empirical data, May (2002) reported shorter runout lengths in older stands. She found that large trees or large woody debris scoured or entrained by debris flows may reduce runout distances.<sup>72</sup> Lancaster et al. (2003) created simulations designed to mirror natural debris flows and concluded that without wood, basin sediment yield increases, runout length increases, and deposits are concentrated in low-gradient reaches. See 6.5.5 for further information on influence of trees along the runout path.

### *Potential for debris flows to evolve into debris floods or hyper-concentrated flows*

The prediction of both channelized and unconfined runout distances is complicated by the potential for debris flows to evolve into debris floods and/or hyper-concentrated flows. A debris flood as classified by Hungr et al. (2001) is a torrent with substantial transport of coarse sediment – a debris flow with a higher water content. Hyper-concentrated flow is a slurry of finer particles, usually with a predominance of sand and coarse sand with some gravel.<sup>73</sup> Pierson and Scott (1985) describe the transformation of debris flows to hyper-concentrated flows from the 1980 eruption of Mt. St. Helens as they traveled down the Toutle River. Their basic hypothesis is that the debris flow entrained additional channel water as it flowed down valley, which caused coarser materials to settle out and become bedload, while the sand-rich hyper-concentrated flow increased its velocity and pulled ahead of the coarser materials. (In this relatively channelized environment, a tail of debris flow materials actually deposited on top of the hyper-concentrated flow deposits.) They describe the hyper-concentrated flow deposits as poorly sorted (i.e., less than typical alluvial materials but more so than debris flow deposits) sands, with faint horizontal stratification but an overall massive appearance, and thin lenses of gravel.

### 6.5.3 Debris Fan Formation

Identifying debris fans and understanding their formation is part of a runout assessment. The presence and size of a debris fan indicates past accumulations of sediment deposits and debris flows. Fans may be constructed from stream deposits (alluvial fans), debris flow deposits (debris

---

<sup>72</sup> May 2002; Lancaster et al. 2003; Robison et al. 1999.

<sup>73</sup> Beverage and Culbertson 1964; Pierson and Scott 1985.

fans), or multiple depositional processes (composite fans). They are typically located at the mouths of canyons. They can also form anywhere a channel loses sufficient confinement to promote deposition as well as at the base of steep slopes.

Landslide runout distances and the amount of direct delivery are influenced by the presence or absence and size of fans. These factors are in turn influenced by the contributing basin and valley width where the fan forms. May and Gresswell (2004) found that smaller drainages had lower recurrence rates of debris flows which led to smaller fans, and where valley width was narrow no fans were present (or were truncated) because rivers and streams eroded the fans faster than they were created. Debris flow delivery potential, particularly from small and confined drainages across narrow valley bottoms, is likely to be high. Conversely, larger drainages had higher recurrence rates which led to larger fans, particularly where valley widths were greater. In addition, the higher recurrence rates down higher order channels sometimes precludes debris flows from continuing to bulk up in the lower channels because they are already devoid of material. Delivery, from larger drainages across wider valley bottoms, may be limited by deposition on a large fan where the main stem is less likely to, or less capable of, eroding.

The processes that create a fan surface (e.g., alluvial or debris flow) can be predicted by the fan gradient and the “Melton number” of the watershed above the fan. The empirical studies that have contributed to this work are summarized in Scheidl and Rickenmann (2010). The Melton number stems from Melton (1965), although it was not identified as such in the original reference. It is calculated by dividing the height of the watershed taken as the maximum elevation, minus the elevation of the fan apex by the square root of the area of the watershed. An ESRI user forum provides clarification of the Melton number, also called the Melton Roughness Number.

Figure 30 from Scheidl and Rickenmann (2010) displays average fan slope on the vertical axis and the Melton number on the horizontal axis. Three diagonal lines labelled “A” are derived from previous empirical studies, and represent observed transitions between purely alluvial processes and mixed processes. The two diagonal lines labelled “B” are also derived from previous empirical studies, and represent observed transitions between mixed processes and debris flow processes.

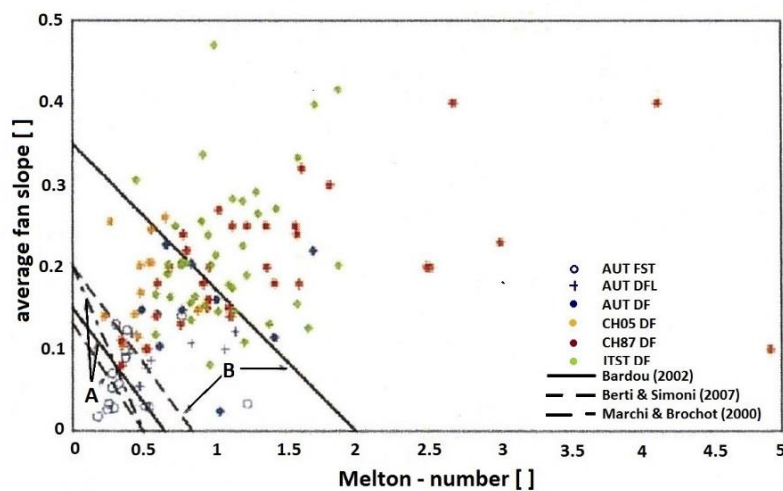


Figure 30. Relation between average fan slope ( $S_f$ ) and Melton number ( $M_E$ ) for European landslide datasets.

*Threshold lines (A and B) distinguish zones with dominant process types, and symbols represent three process types: DF = debris flow, DFL = debris flood, FST = fluvial sediment transport (Scheidl and Rickenmann 2010).*

#### 6.5.4 Methods and Models for Predicting Shallow-Rapid Landslide Runout and Delivery

This part contains brief summaries of selected methods, listed roughly in chronological order of publication, which landslide scientists have developed for estimating shallow-rapid runout distances for various landslide types. Although it is not an exhaustive list, these are included because of their applicability on forest lands in the Pacific Northwest. *If reviewed in their entirety*, they may contain helpful information to supplement professional judgment and experience.

Empirically-based methods for assessing debris flow hazards rely on quantitative data, whereas numerical simulation models use mathematical equations and procedures to arrive at estimates for erosion and depositional processes. Those summarized below are based on data from shallow-rapid landslide events occurring in the Pacific Northwest and British Columbia, and in most cases derived from hundreds of observations. The simplest models can be applied at the field scale using clinometers and range finders in conjunction with digital elevation data. The methods should be applied to conditions similar to those on the site being assessed.

Other methods not listed here may be viable and the appropriate method for a site is left to the analyst. While many of them are at the technical level of a qualified expert, several may be useful for a general practitioner such as the 2003 guidance in the methods in the Tolt Watershed Analysis<sup>74</sup> and the Oregon Department of Forestry's Technical Notes 2 and 6<sup>75</sup>.

##### *Benda and Cundy 1990*

Benda and Cundy's 1990 article, *Predicting deposition of debris flows in mountain channels*, describes an empirically-derived method for predicting potential impacts from debris flows. It is typically referred to as the Benda-Cundy model. The technique uses easily measured topographic criteria (channel slope, channel confinement, and tributary junction angle) to calculate debris flow runout distance from the point of initiation and the final deposition volume of debris flows in steep mountain channels.

The method was developed and tested using data from debris flows in the Oregon Coast Range and the Washington Cascades. An Oregon Department of Forestry study of 361 debris flows<sup>76</sup> validated the model, and numerous resource professionals in the Pacific Northwest have reported good success in applying it to mountain debris flows regionally.

##### *Tolt Watershed Analysis 1993*

The Tolt Watershed Analysis<sup>77</sup> contains mass wasting prescriptions for determining landslide delivery potential based on physical processes from empirical results in northwestern Washington and western Oregon. The *Mass Wasting Delivery Flow Chart Road and Harvest* procedure in the analysis is summarized in the following paragraph. Although intended for use in the Tolt River basin, the method can be applied in other similar physiographic provinces.

<sup>74</sup> Weyerhaeuser Timber Company 1993.

<sup>75</sup> ODF Technical Note 2, 2003 and ODF Technical Note 6, 2003.

<sup>76</sup> Robison et al. 1999.

<sup>77</sup> Weyerhaeuser Timber Company 1993.

In this method, delivery potential for a hypothetical mass failure is determined by considering topographic conditions at the failure initiation site, along the runout path, and at the deposition zone. The assessment is based on slope gradient changes as material travels downslope. If a failure becomes channelized, it becomes a debris flow deposit. As debris flow deposition continues downslope, the potential for a dam-break flood is evaluated based on channel confinement. Estimated runout distances are provided as outputs from the above hillslope and up-channel geomorphology. A description and flow chart illustrating the method is included in the mass wasting prescription chapter. The Tolt Watershed Analysis is available on the Washington State Department of Natural Resources web site at <https://fortress.wa.gov/dnr/protectionsa/ApprovedWatershedAnalyses>.

#### *Coho and Burges 1994*

Coho and Burges identified and characterized a relatively infrequent but distinctive and destructive type of flood wave known as a dam-break flood that can occur and travel long distances in forested watersheds. The study relied on data from observed dam-break floods in the Olympic Mountains and Washington Cascades. Their report contains a simple strategy for evaluating the dam-break flood potential and runout distance with easily measured field and topographically derived criteria (valley width, channel gradient, presence of sufficient small organic debris, and riparian condition) to identify susceptible stream channels and the affected downstream extent.

#### *Dynamic Analysis (DAN) 1995*

To understand the internal strength, erosion ability, and rheology of a landslide, Hungr (1995) developed a numerical model called Dynamic Analysis (DAN). The model was originally developed as a tool for modelling post-failure motion of rapid landslides and can be used for predicting runout. It allows for the selection of a variety of material rheologies, which can vary along the slide path or within the slide mass. The model is calibrated by back analysis and has been widely used in many inverse or back analysis calculations<sup>78</sup> and has been improved over several years.<sup>79</sup> Currently, there are two models used worldwide: DAN-W (release 10) and DAN3D. Both models work best for rock and debris avalanches and but have utility with debris flows.<sup>80</sup> The model was validated on mine tailing failures in southern British Columbia.

#### *Corominas 1996, Hunter and Fell 2003*

Corominas (1996) provided an equation for estimating a travel distance angle based on the type of landslide, slide volume, and degree of confinement. Hunter and Fell (2003) reanalyzed the data and found that for landslides smaller than one million cubic yards, a size typical in Pacific Northwest forests, the following equation is more applicable. For unconfined shallow landslides, the volume and expected height of the landslide from topographic data is applied as follows:

$$\frac{H}{L} = 0.77(\tan \alpha_2) + 0.087$$

<sup>78</sup> Pirulli et al. 2003, Revellino et al. 2004.

<sup>79</sup> Shu et al. 2014.

<sup>80</sup> Oldrich Hungr, personal communication, June 2015.



H and L are the landslide height and travel distance respectively;  $\alpha_2$  is the downslope angle (Figure 31).

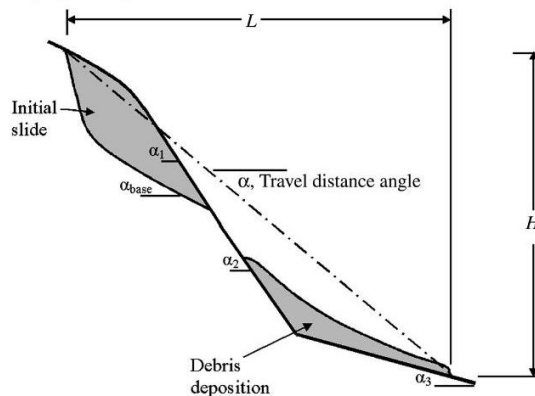


Figure 31. Cross section showing travel distance, travel distance angle, and slope geometry (Hunter and Fell 2003).

The equation above could be applied to unconfined shallow-rapid landslides.

#### Acme Watershed Analysis 1999

A sediment delivery model for open slopes was developed for the Acme Watershed in Washington.<sup>81</sup> It is based on empirical observations that debris flows can develop a coulomb-viscous rheology controlled by the shear stress of the moving debris and the resistance to that stress, which determines the critical thickness (the landslide thickness at deposition). Use of the model requires assumptions regarding landslide initiating volume, moisture content of the debris, gradient of the slope over which the debris is transported, yield strength of the debris, and slope roughness as influenced by trees, stumps, and surface morphology. The model should not be applied to thin soils on hillslopes greater than 70%. Other model limitations are described in the Acme Watershed Analysis mass wasting document. Model predictions are presented in tabular form to aid the field practitioner in using a range of hillslope gradients and landslide volume classes. The Acme Watershed Analysis is available on the Washington State Department of Natural Resources web site at <https://fortress.wa.gov/dnr/protectionsa/ApprovedWatershedAnalyses>.

#### UBCDFLOW (University of British Columbia) 2001

The UBCDFLOW model is based on field observations of landslides from clearcuts.<sup>82</sup> Four sites in coastal British Columbia with 449 events were used to develop the model for predicting debris flow travel distance in confined and unconfined (open) slopes. All of the sites were glaciated and included areas in western Vancouver Island with similar geology and climate as Washington State. The study found that the total entrainment volume along runout paths does not equal the total volume deposited. Inspection of the survey data showed that "...reach morphology exerts a strong influence on flow behavior."<sup>83</sup> The model, complete with a user guide and tutorial, is available at <http://dflow.civil.ubc.ca/>.

#### Oregon Department Forestry Technical Guidance 2003

<sup>81</sup> Crown Pacific Limited Partnership 1999.

<sup>82</sup> Fannin and Wise 2001.

<sup>83</sup> Ibid.

The Oregon Department of Forestry developed technical guidelines to maintain regulatory compliance with the landslides and public safety rules for shallow, rapidly moving landslides. The guidance is detailed in two technical documents<sup>84</sup> to guide forest practices activities where shallow landslide hazards exist, and is based on published empirical data from the Pacific Northwest and British Columbia.

- Technical Note Number 2, *High Landslide Hazard Locations, Shallow, Rapidly Moving Landslides and Public Safety: Screening and Practices*, is intended for engineers and foresters in conducting the initial public safety screening; i.e., to determine if an operation is subject to shallow rapid landslides and Oregon's public safety rules. Part B provides guidance on how to determine the downslope extent of regulatory Further Review Areas for proposed operations. It provides gradient, confinement, and runout metrics for channelized and open slope topography.
- Technical Note Number 6, *Determination of Rapidly Moving Landslide Impact Rating*, assists geotechnical specialists in completing detailed, field-based investigations of associated upslope hazards and downslope public safety risks. The guidance draws upon Benda and Cundy (1990), Robison (1999), and Benda (1999). Although it is intended for use within the context of Oregon's regulations, it can be applied throughout the Pacific Northwest for predicting shallow-rapid landslide runout and delivery potential.

*Hungr et al. 2005; Corominas et al. 2014*

Evaluating where previous landslides have deposited is applicable to forecasting the extent of possible future debris flow hazards.<sup>85</sup> Using historic landslide inventory data is appropriate because it is based on field observations of past landslide runout behavior.<sup>86</sup> These measurements are used to forecast future runout distances. However, the shortcomings of this technique include the fact that old deposits may be modified by more recent events that erode or cover them up, and the technique is best to use in areas where large events occur infrequently.<sup>87</sup> Additionally, this technique may not be transferable to other areas because the size, type, and driving forces may be different for future events in other locations.<sup>88</sup> Because landslide deposits have similar textural properties to glacial deposits (e.g., unsorted and unstratified), Hungr et al. (2005) suggest that careful evaluation of the deposits is necessary to differentiate between the two in glaciated areas.

*Prochaska et al. 2008*

Prochaska et al. (2008) provide a simple topographic model that utilizes parameters that can be measured without estimating initiation point, initiation volume, or the down-valley bulk-up process. The model only applies to debris flows that reach a fan apex. Prochaska et al. (2008) do not present a final formula and do not show any of their calculations, nor do they provide sufficient data to check any of their calculations. For that reason, a user-friendly formula is provided below.

---

<sup>84</sup> ODF Technical Notes 2 and 6, 2003.

<sup>85</sup> Hungr et al. 2005.

<sup>86</sup> Corominas et al. 2014.

<sup>87</sup> Corominas et al. 2014.

<sup>88</sup> Ibid.

The model predicated on determining the elevation of the highest point in the drainage and the elevation of the apex of the fan. The half-height, which is the elevation half way between the first elevations, is located on the stream in the example below.  $\beta$  is the angle in degrees between the half-height and the MAX and fan apex; it is calculated by measuring the horizontal distance to the fan apex.  $\alpha$  equals 0.88 times  $\beta$  where  $\alpha$  is the angle in degrees from 0.5 times height to the end of the runout. Using  $\alpha$  to project the runout down the fan surface requires knowing the fan gradient. A licensed professional engineer created a formula where  $\beta$  can be calculated in percent and the fan gradient measured in percent; the calculation then requires arctan to convert  $\beta$  to degrees before multiplying by 0.88, and then tan to convert the  $\alpha$  value back to percent.  $\alpha$  does not actually appear in the formula; it is present as  $[(\arctan(\beta\%))*0.88]$ .

$$\text{Runout} = 0.5 h [(\beta\% - f\%) / ((\tan[(\arctan(\beta\%))*0.88] - f\%) - 1)]$$

Where:

$h$  = elevation of highest point of the drainage – elevation of fan apex

$\beta\%$  =  $0.5 h$  / horizontal length between the midpoint of elevation and the fan apex  
(this value is a decimal %, not a degree)

$f\%$  = average gradient of the fan in decimal %

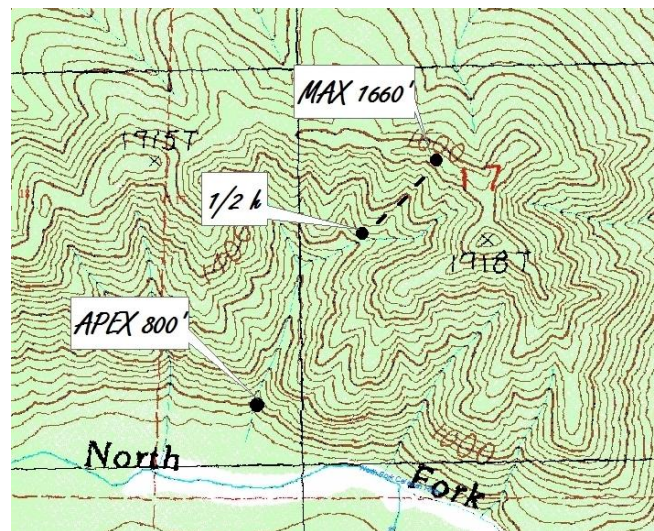


Figure 32. From USGS 7.5' Deadmans Hill Topographic Quadrangle.

Maximum elevation of the small watershed is 1660 feet. Fan apex is 800 feet. The variable  $1/2h$  (labeled) equals 1230 feet.  $B\%$  is 0.243 (calculated from topo sheet);  $f\%$  is 0.10 (field measured).

Runout is 163 feet as estimated by the formula presented above.

#### Guthrie et al. 2010

Using over 1700 field observations supplemented by aerial photography interpretation in British Columbia on Queen Charlotte and Vancouver Islands, Guthrie et al. (2010) examined landslide deposits from open sloped and channelized debris flows. They used these data to develop a sediment balance approach (erosion versus deposition) to estimate runout in similar terrain. Their study found that deposition occurred on open slopes between 32% and 45%.

These are steeper angles than those found in other local studies.<sup>89</sup> Channelized debris flows deposited between 21% and 27%. The study also determined that one of the reasons for the steeper deposition slope angles was boundary trees. After traveling through logged slopes, most of the debris flows stopped entirely within 150 feet of the boundary in 72% of the examined flows.

#### 6.5.5 Runout Mitigation Strategy: Barrier Trees

If landslide initiation site avoidance, application of rule-required RMZs, or other mitigation measures appear inadequate, debris flow runout may be further mitigated by leaving barrier trees in the low gradient depositional reaches of debris flow-prone streams. Barrier trees can be retained to encourage the deflection, deceleration, and/or deposition of debris flows<sup>90</sup> and dam-break floods.<sup>91</sup>

Riparian forests adjacent to larger channelized streams add woody debris and act as natural barriers to debris flows, independent of management practices. Furthermore, standing trees in mature forests may promote more rapid deposition, which can minimize landslide size.<sup>92</sup> Therefore, leaving mature trees where forest practices rules do not require RMZs (i.e., portions of Type N waters) may reduce landslide impacts. Large trees near the areas of debris flow deposition (such as on fans at the mouths of steep tributaries) may be the most effective in inhibiting movement and protecting structures and highways.<sup>93</sup> Trees can also be retained or restored on the sides of a potential debris flow runout path to constrain its lateral movement and protect structures on a debris fan.<sup>94</sup>

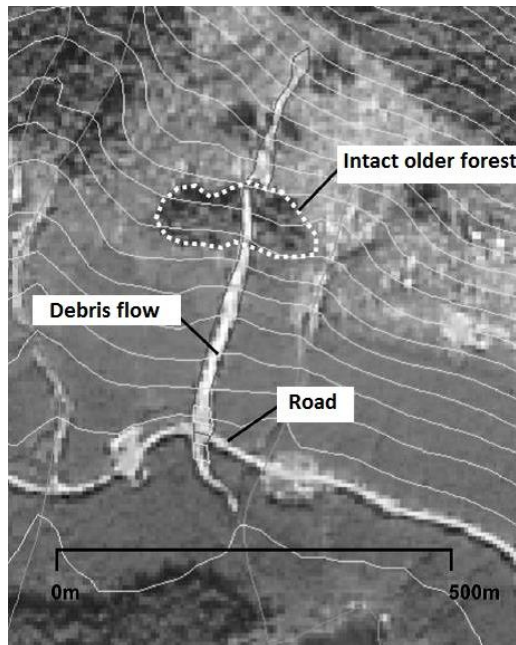


Figure 33. Debris flow path (from bottom to top of the photo) showing width changes from traveling through an older forest stand (Guthrie 2010).

<sup>89</sup> Hungr et al. 1984; Fannin and Wise 2001; Horel 2007.

<sup>90</sup> VanDine 1996, Benda et al. 1998, Guthrie et al. 2010.

<sup>91</sup> Coho et al. 1994.

<sup>92</sup> Guthrie et al. 2010.

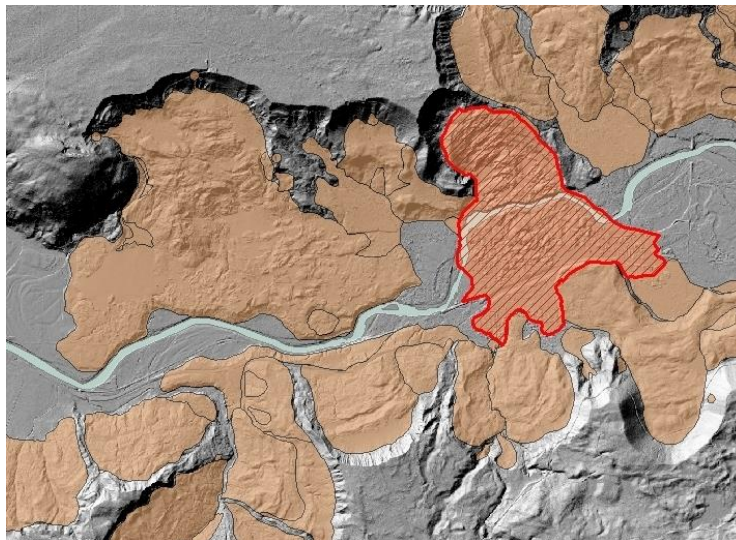
<sup>93</sup> Benda et al. 1998.

<sup>94</sup> Eisbacher and Clague 1984.

Figure 33 shows the path of an open slope debris flow initiated from a clearcut that traveled through a small stand of older forest to where it narrowed considerably following the contact with the forest edge. The debris flow increased in width as it entrained additional material below the intact forest, and a slight reduction in width is evident below the road before it stopped at the lower gradient valley floor.

#### 6.5.6 Deep-Seated Landslide Runout Evaluation

The same tools used to identify deep-seated landslides (Parts 2.3, 5.1.4) can be used by the qualified expert during an evaluation of runout distances. For example, landslide deposits are mapped with variable accuracy on geologic maps and landslide inventories. They are more accurately mapped during field reconnaissance and with high-resolution topographic data such as LiDAR bare earth DEM. The extent of past landslide deposits at a given site, or in similar geologic materials in the vicinity, may indicate the extent of future landslide deposits<sup>95</sup>. For instance, Figure 34 shows the approximate runout distance of neighboring glacial deep-seated landslides in the North Fork Stillaguamish River valley. When assessing the potential runout distance of a deep-seated landslide, it is important to examine not only the immediate vicinity but also the larger landscape (at least at 1:24,000 scale) for evidence of past landslide deposits. In cases where recent fluvial erosion or deposition has eroded or buried older landslide deposits, the true extent of older deposits may be underestimated by current morphology. A runout evaluation may be used to supplement other site-specific assessments such as landslide chronology, stratigraphy, mechanics and river channel migration.



*Figure 34. LiDAR derived image revealing past glacial deep-seated landslide deposits in the Stillaguamish River valley. The crosshatch polygon marks the approximate extent of the 2014 SR 530 landslide. (DNR 2016).*

---

<sup>95</sup> Schulz 2007.

**PART 7. SYNTHESIS OF RESULTS, EVALUATION, AND GEOTECHNICAL REPORTS**

This part is intended for qualified experts when preparing geologic evaluations. The following questions and guidance are provided to assist the qualified expert when synthesizing the information assembled in the office review and field assessment, and can be useful when preparing a geologic evaluation or report.

**7.1 Synthesis and Evaluation**

Consideration of the following questions may help to synthesize findings:

- Based on an analysis of available information, what is the geotechnical interpretation of physical processes governing unstable slope/landform movement, mechanics, and chronologies of each identified feature?
- What are the project limitations (e.g., quantity or quality of technical information, site access, project timeframe) that might influence the accuracy and precision of identifying, delineating, and interpreting unstable slopes and landforms?
- What are the scientific limitations (e.g., collective understanding in the scientific community of landform physical processes) that might influence the identification, delineation, and interpretation of unstable slopes and landforms?
- What is the potential for material delivery from each relevant unstable slope and landform to areas of public resource sensitivity or where public safety could be threatened?
- What are the relative roles of natural processes and land management activities in triggering or accelerating instability?
- What level of confidence is placed in the identification, delineation, and interpretation of unstable slopes and landforms? How does the confidence level impact any recommendations for unstable slope management and/or mitigation?

Models for slope stability and sensitivity (see 6.4) may be used to support analyses of potentially unstable slope and landform characteristics and mechanics. If modeled results are included in reports, they should be accompanied by a statement of model assumptions, analysis limitations, and alignment with existing information (e.g., field data). For example, it would not be appropriate to include a modeled reconstruction of landslide failure-plane geometry based on data from one borehole or drive probe sample. The modeled results would likely be misleading and could result in spurious conclusions.

To provide the necessary information for DNR to evaluate a proposal, the analytical methods and processes used by the qualified expert to identify, delineate, and interpret unstable slopes and landforms should be described in their reports along with information sources, data processing techniques, and the limitations of analysis results. Reports should describe all assumptions regarding input parameters or variables, such as groundwater surface elevation estimates employed in stability sensitivity analyses, as well as the reasoning for their use. Reports may also include an assessment of the sensitivity of the analytical method or model results to parameter variability. This is especially true where only a range of parameter values is available, or where input values are extrapolated or estimated from other locations or databases.

Confidence levels in the slope stability analysis and model results are influenced by many factors including project complexity and objectives; site characteristics (e.g., acreage and accessibility); project timeframes; quantity and quality of available information (e.g., reports, databases) and

remotely sensed data; accuracy and precision of field observations and collected data; and the rigor of available analytical methods and models. A discussion of the primary limiting factors will assist the landowner and report reviewer when evaluating the potential public resource, public safety, and liability risks associated with implementing a project.

Documentation of the project analysis may include annotated images (e.g., LiDAR-derived hillshades, aerial photos); geologic or topographic profiles; maps; sketches; results of subsurface investigations; summaries of computational or simulation modeling; summaries of previously published information; and remotely sensed or field-derived data and text to explain the concrete evidence and logical train of thought for the conclusions and recommendations that will be presented in the geotechnical report.

## **7.2. Geotechnical Reports**

When harvesting timber or building roads on potentially unstable slopes, a written report is required to be part of the FPA to explain whether the proposed forest practices are likely to affect slope stability, deliver sediment and debris to public resources, or threaten public safety. For the purposes of this Board Manual section, such a report is called a “geotechnical report.” The geotechnical report is prepared by a qualified expert and must meet the requirements described in WAC 222-10-030(1). If the FPA is classed as a Class IV-special, the applicant must also include a SEPA checklist and additional information listed in WAC 222-10-030.

Qualified experts must be licensed with Washington’s Geologist Licensing Board. Specific rules addressing a geologist’s professional conduct are listed in WAC 308-15-140(1) and (2). For more information about the geologist licensing process, refer to WACs 308-15-010 through 308-15-150, or see the Geologist Licensing Board’s web site at [www.dol.wa.gov/business/geologist](http://www.dol.wa.gov/business/geologist). The education and field experience on forest lands is required, in addition to the appropriate geologist license.

The qualified expert is encouraged to consult with DNR Region geologists when preparing a geotechnical report to ensure important elements are covered. Region contact information is available on DNR’s web site at <http://www.dnr.wa.gov/contact-us>.

The report should be as detailed as necessary to address these and any other relevant elements:

- (a) *Prepare an introductory section.* This section should describe the qualified expert’s qualifications. It should also reference the FPA number if previously submitted, landowner and operator names, and a brief description of site observations to the area, including dates and relevant weather conditions.
- (b) *Describe the geographic, geologic, and soil conditions of the area in and around the application site.* Include a vicinity map and geographical location of the proposal area and, where appropriate, the distance and direction from the nearest municipality, local landmarks, and water bodies. Provide elevations and aspect. Describe the underlying parent materials, including their origin (i.e., glacial versus bedrock); the name(s) of any rock formations and their associated characteristics; and geologic structure relevant to slope stability. Describe soils and rocks on site based on existing mapping, field observations, and any available local information.

Describe soil and rock texture, depth, and drainage characteristics typically using standard soil and rock classification systems.<sup>96</sup>

- (c) *Describe the potentially unstable landforms within and around the site.* Include a general description of the topographic conditions of the site. Specifically, identify the potentially unstable landforms located in the area (i.e., those defined in WAC 222-16-050 (1)(d)(i)), in addition to any other relevant landforms on or around the site. Describe in detail the gradient, form (shape), and approximate size of each potentially unstable landform. Include a description of the mass wasting processes associated with each identified landform, as well as detailed observations of past slope movement and indicators of potential future landslide activity.

Relevant field observations, important features, and sampling locations used in project analysis can be displayed on a map in the geotechnical report. Relevant photos and data-sampling observation points should be geo-referenced (i.e., with GPS waypoints) and mapped. GPS track locations of field traverses can indicate which portions of the project site were evaluated. In addition, field-derived cross sections and geologic profile locations should be geo-referenced. Assign a unique alphabetic or numeric identifier label to each landform or observation point relevant to the assessment and note these on a detailed site map of a scale sufficient to illustrate site landforms and features. Where the proposal involves operations within the groundwater recharge area of a glacial deep-seated landslide, specifically discuss the probable direct and indirect impacts to groundwater levels and those impacts to the stability of the landslide.

- (d) *Analyze the possibility that the proposed forest practice will cause or contribute to movement on the potentially unstable slopes.* Explain the proposed forest management activities on and adjacent to the potentially unstable slopes and landforms. Clearly illustrate the locations of these activities on the site map, and describe the nature of the activities in the text. Discuss in detail the likelihood that the proposed activities will result in slope movement (separate activities may warrant separate evaluations of movement potential). The scope of analysis should be commensurate with the level of resource and/or public risk. Include a discussion of both direct and indirect effects expected over the short- and long-term. For proposals involving operations on or in the groundwater recharge area of a glacial deep-seated landslide, conduct an assessment of the effects of past forest practices on landslide/slope movement. Explicitly state the basis for conclusions regarding slope movement. Conclusions are based on professional experience, field observations, unpublished local reports, watershed analyses, published research findings, and/or slope stability model output. Input parameters, model assumptions, and methods should be fully substantiated within the report.
- (e) *Assess the likelihood of delivery of sediment and/or debris to any public resources, or to a location that would threaten public safety, should slope movement occur.* Include an evaluation of the potential for sediment and/or debris delivery to public resources or areas where public safety could be threatened. Discuss the likely magnitude of an event, if one were to occur. Separate landforms may warrant separate evaluations of delivery and magnitude. Explicitly state the basis for conclusions regarding delivery. Conclusions are based on professional experience, field observations, unpublished local reports, watershed analyses, published research findings, and/or landslide runout model results, which should have site-specific data. Input parameters,

---

<sup>96</sup> e.g., Unified Soil Classification System (USCS), American Association of State Highway and Transportation Officials (AASHTO) and Rock Mass Rating (Bieniawski 1989).



model assumptions, and methods using best available data should be fully substantiated within the report.

- (f) *Suggest possible mitigation measures to address the identified hazards and risks.* Describe any modifications necessary to mitigate the possibility of slope movement and delivery due to the proposed activities. If no such modifications are necessary, describe the factors inherent to the site or proposed operation that might reduce or eliminate the potential for slope movement or delivery. For example, an intact riparian buffer downslope from a potentially unstable landform may serve to intercept or filter landslide sediment and debris before reaching the stream. Discuss the risks associated with the proposed activities relative to other alternatives, if applicable. Some geotechnical reports might include recommendations regarding additional work needed to supplement the report, including but not limited to monitoring by the landowner or their designated qualified expert of geologic conditions (e.g., groundwater, slope movement) and review of plans and specifications.

Conclusions should include documentation of the outcomes of the slope stability investigation based on the synthesis of all geologic and hydrologic information and interpretations used in the office review and field assessment, qualitative information and data analyses, geo- and hydro-technical modeling, and evaluation of material deliverability. Conclusions might also include a description of the suitability of the proposed activity for the site, and likely direct and indirect effects of the activity on the geologic environment and processes. Conclusions should be substantiated by the evidence presented and the expert's logical thought processes during analysis and synthesis.

**GLOSSARY**

<b>Aquifer</b>	Saturated permeable geologic unit that can transmit significant quantities of water under ordinary hydraulic gradients.
<b>Aquitard</b>	A less permeable bed in a stratigraphic sequence.
<b>Complex deep-seated landslide</b>	A combination of at least two types of movement (slide, fall, topple, flow or spread) within the same landslide.
<b>Compound deep-seated landslide</b>	A large host landslide that encompass smaller secondary slides during a single event or over time.
<b>Confined aquifer</b>	An aquifer that is confined between two aquitards. Confined aquifers occur at depth.
<b>Debris avalanche</b>	The very rapid and usually sudden sliding and flowage of incoherent, unsorted mixtures of soil and weathered bedrock.
<b>Discontinuity</b>	A plane or surface that marks a change in physical or chemical characteristics in a soil or rock mass (bedding, joint, fracture, or fault plane).
<b>Driller's log</b>	The brief notations included as part of a driller's tour report, that describes the gross characteristics of the well cutting noted by the drilling crew. It is useful only if a detailed sample log is not available. Driller's logs may also include information on groundwater elevation.
<b>Earthflow</b>	A slow flow of earth lubricated by water, occurring as either a low-angle terrace flow or a somewhat steeper but slow hillside flow.
<b>Engineering geology</b>	Performance of geological service or work including but not limited to consultation, investigation, evaluation, planning, geological mapping, and inspection of geological work, and the responsible supervision thereof, the performance of which is related to public welfare or the safeguarding of life, health, property, and the environment, and includes the commonly recognized practices of construction geology, environmental geology, and urban geology.
<b>Evapotranspiration</b>	A combination of evaporation from open bodies of water, evaporation from soil surfaces, and transpiration from the soil by plants. Commonly designated by the symbols (Et) in equations.
<b>Factor of safety</b>	The ratio of the resistant force acting on the sliding surface to the driving force acting on the potential slide mass. When the factor of safety is greater than one (1), the slope is stable; when the factor of safety is less than one (1), the slope is unstable.

<b>Fluvial</b>	Pertains to the deposits and landforms produced by the action of a river or a stream.
<b>Glacial outwash</b>	Sediment deposited by meltwater streams beyond a glacier, typically sorted and stratified sand and gravel.
<b>Graben</b>	A block, generally long compared to its width that has been downthrown along faults relative to the rocks on either side.
<b>Groundwater</b>	Subsurface water that occurs in soils and geologic formations. Encompasses subsurface formations that are fully saturated and near-surface, unsaturated, soil-moisture regimes that have an important influence on many geologic processes.
<b>Groundwater Recharge area</b>	An area or drainage basin in which water reaches the zone of saturation following infiltration and percolation. Beneath it, downward components of hydraulic head exist and groundwater moves downward into deeper parts of the aquifer. “Groundwater recharge areas for glacial deep-seated landslides” is defined in WAC 222-16-010.
<b>Glacial terrace</b>	A relatively flat, horizontal, or gently inclined surface formed by glacial processes, sometimes long and narrow, bounded by a steeper ascending slope on one side and a steeper descending slope on the opposite side.
<b>Glaciolacustrine</b>	Pertains to, derived from, or deposited in glacial lakes. Glaciolacustrine deposits and landforms are composed of suspended material brought by meltwater streams flowing into lakes.
<b>Glaciomarine</b>	Pertains to sediments which originated in glaciated areas and have been transported to an ocean’s environment by glacial meltwater.
<b>Glacial till</b>	Matrix-supported, non-sorted, non-stratified sediment carried or deposited by a glacier. If over-ridden by a glacier, it can become compacted. Compacted till can be nearly impermeable and can sometimes perch water.
<b>Hydrogeology</b>	The science that involves the study of the occurrence, circulation, distribution, chemistry, remediation, or quality of water or its role as a natural agent that causes changes in the earth; the investigation and collection of data concerning waters in the atmosphere or on the surface or in the interior of the earth, including data regarding the interaction of water with other gases, solids, or fluids.
<b>Hydraulic head</b>	Combined measure of the elevation and the water pressure at a point in an aquifer which represents the total energy of the water; since groundwater moves in the direction of lower hydraulic head (i.e., toward lower energy),

and hydraulic head is a measure of water pressure, groundwater can and often does flow uphill.

<b>Hydrologic budget</b>	An accounting of the inflow to, outflow from, and storage in a hydrologic unit such as a drainage basin, aquifer, soil zone, or water body. For watersheds, the major input is precipitation and the major output is stream flow.
<b>LiDAR</b>	Light Detection and Ranging. A detection system that works on the principle of radar, but uses light from a laser.
<b>Lithology</b>	The study of general physical characteristics of rocks.
<b>Resistivity method</b>	A geophysical method that observes the electric potential and current distribution at the earth's surface intended to detect subsurface variation in resistivity which may be related to geology, groundwater quality, porosity, etc.
<b>Rheology</b>	The branch of physics that deals with the deformation and flow of matter, especially the non-Newtonian flow of liquids and the plastic flow of solids.
<b>Seismic method</b>	A geophysical method using the generation, reflection, refraction, detection and analysis of seismic waves in the earth to characterize the subsurface.
<b>Soil</b>	The unconsolidated mineral or organic material on the immediate earth's surface that serves as a natural medium for the growth of plants.
<b>Strata</b>	Plural of stratum.
<b>Stratum</b>	A section of a formation that consists throughout of approximately the same material. A stratum may consist of an indefinite number of beds, and a bed may consist of numberless layer. The distinction of bed and layer is not always obvious.
<b>Stratification</b>	A structure produced by the deposition of sediments in beds or layers (strata), laminae, lenses, wedges, and other essentially tabular units.
<b>Unconfined aquifer</b>	Aquifer in which the water table forms the upper boundary. Unconfined aquifers occur near the ground surface.
<b>Water table</b>	The surface on which the fluid pressure in the pores of a porous medium is exactly atmospheric. The location of this surface is revealed by the level at which water stands in a shallow well open along its length and penetrating the surficial deposits just deeply enough to encounter standing water at the bottom.

**REFERENCES**

- Acme Watershed Analysis: Crown Pacific Limited Partnership and Washington Department of Natural Resources (1999), v.1, (unpaginated).
- Adams, W.C., R.W. Prellwitz, and T.E. Koler (2007). Low-Technology Approach to Evaluating Slope Stability in Forested Uplands. IN: First North American Landslide Conference, Vail, CO, 569-577.
- American Society for Testing and Materials (ASTM) (2014). Standard test method for Standard Penetration Test (SPT) and split-barrel sampling of soils. IN: Book of Standards, (published by ASTM International, Subcommittee D18.02), 04.08, Active Standard ASTM 1586, 9.
- Ardizzone, F., M. Cardinali, M. Galli, F. Guzzetti, and P. Reichenbach (2007). Identification and mapping of recent rainfall-induced landslides using elevation data collected by airborne lidar. *Natural Hazards Earth Systems Science*, 7, 637-650.
- Avery, C.C. and L.J. Fritschen (1971). Hydrologic and energy budgets of stocked and on-stocked Douglas-fir sites as calculated by meteorological methods. Research completion report for U.S. Department of Interior, Office of Water Resources Research, 130.
- Badger, T.C. (1993). Structurally-controlled landslides northwestern Olympic Peninsula, USA, Proceedings for Geotechnical Engineering of Hard Soil/Soft Rock, Athens, Greece, 1051-1056.
- Barnosky, C. W. (1984). Late Pleistocene and early Holocene environmental history of southwestern Washington State, USA. *Canadian Journal of Earth Sciences*, 21(6), 619-629.
- Bauer, H.H. and A.J. Hansen (2000). Hydrology of the Columbia Plateau regional aquifer system, Washington, Oregon, and Idaho. U.S. Geological Survey, Water Resources Investigations Report 96-4106, 61.
- Bauer, H.H., and Mastin, M.C. (1997). Recharge from precipitation in three small glacial-till mantled catchments in the Puget Sound lowland, Washington. U.S. Geological Survey, Water Resources Investigations Report 96-4219, 119.
- Bauer, H.H. and J.J. Vaccaro (1987). Documentation of a deep percolation model for estimating ground-water recharge. U.S. Geological Survey, Open File Report 86-536, 180.
- Benda, L. and T.W. Cundy (1990). Predicting deposition of debris flows in mountain channels. *Canadian Geotechnical Journal*. V. 27, 409-417.
- Benda, L. E., G. W. Thorsen, and S.C. Bernath (1988). Report of the ID team Investigation of the Hazel landslide on the north fork of the Stillaguamish River (FPA 19-09420): Washington Department of Natural Resources [unpublished report], 13.
- Benda, L., C. Veldhuisen, D. Miller, and L.R. Miller (1998). Slope instability and forest land managers: A primer and field guide. Earth Systems Institute, 74.

- Benda, L. (1999). Method to Predict Landslide Runout on Non-Convergent Hillslopes, Appendix 3-1. IN: Crown Pacific Limited Partnership (1999), Acme Watershed Analysis (1999). See Washington Department of Natural Resources at <https://fortress.wa.gov/dnr/protectionsa/ApprovedWatershedAnalyses>.
- Berti, M., A. Corsini, and A. Daehne (2013). Comparative analysis of surface roughness algorithms for the identification of active landslides. *Geomorphology* 182, 1-18.
- Beverage, J.P. and J.K. Culbertson (1964). Hyperconcentrations of suspended sediment. *J. Hydraulics Div. Am. Soc. Civ. Eng.*, 90(HY-6), 117-128.
- Bieniawski, Z.T. (1989). *Engineering rock mass classifications: a complete manual for engineers and geologists in mining, civil, and petroleum engineering*. Canada: John Wiley and Sons.
- Booth, A.M., J.J. Roering, and J.T. Perron (2009). Automated landslide mapping using spectral analysis and high-resolution topographic data: Puget Sound lowlands, Washington, and Portland Hills, Oregon. *Geomorphology* 109, 132–147.
- Booth, D.B., B.S. Golstein, R. Lasmanis, R.B. Cheney, and R.B. Waitt (1994). Patterns and processes of landscape development by the Puget Lobe Ice Sheet. Washington Division of Geology and Earth Resources, Bulletin 80, 207-218.
- Booth, D.B., K.G. Troost, J.J. Clague, (2003). The Cordilleran ice sheet. In Gillepsie, A.R., Porter, S.C., and Atwater, B.F. (Eds.), *The Quaternary Period in the United States, Developments in Quaternary Science*, 1, 17-38
- Bosch, J. M. and J.D. Hewlett (1982). A review of catchment experiments to determine the effect of vegetation changes on water yield and evapotranspiration. *Journal of hydrology*, 55(1), 3-23.
- Bovis, M. J. (1985). Earthflows in the interior plateau, southwest British Columbia. *Canada Geotechnical Journal*, 22, 313-334.
- Burns, W. J. and I.P. Madin (2009). Protocol for inventory mapping of landslide deposits from light detection and ranging (LiDAR) imagery, Oregon Dept of Geology Mineral and Industries (DOGAMI), Portland, Special Paper 42.
- Burns, W.J., J.A. Coe, B.S. Kaya, and M. Lina (2010). Analysis of elevation changes detected from multi-temporal LiDAR surveys in forested landslide terrain in Western Oregon, *Environmental and Engineering Geoscience*, 16(4), 315-341.
- Campbell, G.S. (1986). *An introduction to environmental biophysics*. New York: Springer-Verlag.
- Carter, W., R. Shrestha, G. Tuell, D. Bloomquist, and M. Sartori (2001). Airborne laser swath mapping shines new light on Earth's topography. *EOS, Transactions American Geophysical Union*, 82(46), 549-555.

- Chatwin, S.C., D.E. Howes, J.W. Schwab, and D.N. Swanston (1994). A guide for management of landslide-prone terrain in the Pacific Northwest, Second Edition. British Columbia Ministry of Forests, Land Management Handbook 18, 220.
- Coho, C. S. and S.J. Burges (1994). Dam-break floods in low order mountain channels of the Pacific Northwest: University of Washington Department of Civil Engineering Water Resources Series Technical Report 138; Timber, Fish and Wildlife Program TFW-SH9-93-001, 70.
- Corominas, J. (1996). The angle of reach as a mobility index for small and large landslides. *Canadian Geotechnical Journal*, 33, 260–271.
- Corominas, J., C. van Westen, P. Frattini, L. Cascini, J.P. Malet, S. Fotopoulou, ... J.T. Smith. (2014). Recommendations for the quantitative analysis of landslide risk. *Bulletin of Engineering Geology and the Environment*. 73, 209-263.
- Corsini, A., L. Borgatti, F. Coren, and M. Vellico (2007). Use of multitemporal airborne lidar surveys to analyze post-failure behavior of earth slides, *Canadian Journal of Remote Sensing*, 33(2), 116-120.
- Crandall, D.R. (1965). *The Glacial History of Western Washington and Oregon*. Princeton. Princeton Univ. Press.
- Cronin, V. S. (1992). Compound landslides: Nature and hazard potential of secondary landslides within host landslides. *Geological Society of America Reviews in Engineering Geology*, 9, 1-10.
- Crozier, M.J., E.E. Vaughan, and J.M. Tippett (1990). Relative instability of colluvium-filled bedrock depressions. *Earth Surface Processes and Landforms* 15(4), 329-339.
- Crown Pacific Limited Partnership (1999), Acme Watershed Analysis (1999). See Washington Department of Natural Resources at <https://fortress.wa.gov/dnr/protectionsa/ApprovedWatershedAnalyses>.
- Cruden, D.M. and D. J. Varnes (1996). Landslide types and processes. IN: Turner, A.K., Schuster, R.L. (Eds.), *Landslides investigation and mitigation*. National Academy Press, National Research Council Transportation Research Board Special Report 247, 36-75.
- Daehne, A. and A. Corsini (2013). Kinematics of active earthflows revealed by digital image correlation and DEM subtraction techniques applied to multi-temporal LiDAR data. *Earth Surface Processes and Landforms*, 38(6), 640-654.
- DeLong, S. B., S.C. Prentice, G.E. Hilley, and Y. Ebert (2012). Multitemporal ALSM change detection, sediment delivery, and process mapping at an active earthflow, *Earth Surface Processes and Landforms*, 37(3), 262-272.

- Dietrich, W.E., T. Dunne, N.F. Humphrey, and L.M. Reid (1982). Construction of sediment budgets for drainage basins. IN: *Sediment Budgets and Routing in Forested Drainage Basins*, USDA Forest Service, Pacific Northwest Research Station, General Technical Report PNW-141, 5-23.
- Dietrich, W. E., J. McKean, D. Bellugi, and T. Perron (2007). The prediction of shallow landslide location and size using a multidimensional landslide analysis in a digital terrain model. IN: C. L. Chen and J. J. Major (editors), *Debris-Flow Hazards Mitigation: Mechanics, Prediction, and Assessment: Proceedings 4th International DFHM Conference*, Chengdu, China, September 10-13, 2007, Millpress, Amsterdam, The Netherlands (peer reviewed), 12.
- Dietrich, W.E., C.J. Wilson, and S.L. Reneau (1986). Hollows, colluvium, and landslides in soil-mantled landscapes. IN: *Hillslope Processes*, 361-388.
- Dingman, S. L. (1994). *Physical Hydrology*: Englewood Cliffs, N.J.: Prentice Hall, 575.
- Dingman, S. L. (2002). *Physical Hydrology*: Upper Saddle River, N.J.: Prentice Hall, 646.
- Edmondo, G.P. (2002). Digital geologic mapping using ArcPad, U.S. Geological Survey Open-File Report 02-370.
- Eisbacher, G.H. and J.J. Clague. (1984). Destructive mass movements in high mountains: hazard and management. *Geol. Survey. Can., Pap.* 84-16. 230.
- Fannin, R.J. and M.P.W. Wise (2001). An empirical-statistical model for debris flow travel distance, *Canadian Geotechnical Journal*, 38(5), 982-994.
- Fannin, R. J. and T.P. Rollerson (1993). Debris flows: Some physical characteristics and behavior, *Canadian Geotechnical Journal*, 30:71-81.
- Freeze, R. A. and J. Cherry (1979). *Groundwater*. Englewood Cliffs, N.J.: Prentice Hall, Inc., 604.
- Fritschen, L. J., H.R. Holbo, and M.O. Smith (1975). Evapotranspiration of four forest types measured with the Eddy Correlation Technique. Project Completion Report, OWRR A-061-WASH. University of Washington, Seattle, Washington.
- Geertsema, M. and J.J.Pojar (2007). Influences of landslides on biophysical diversity: A perspective from British Columbia. *Geomorphology* 89, 55-69.
- Gerstel, W. J., M.J. Brunengo, W.S. Lingley, Jr., R.L. Logan, H. Shipman, and T.J. Walsh (1997). Puget Sound bluffs: The where, why, and when of landslides following the holiday 1996/97 storms. *Washington Geology*, 25(1), 17-31.
- Gerstel, W.J. and T.C. Bagder (2002). Hydrologic controls and forest land management implications for deep-seated landslides: examples from the Lincoln Creek Formation, Washington, *Geological Society of America, Abstracts with Programs*, 34(5), 89.



- Glenn, N. F., D.R. Streutker, D.J. Chadwick, G.D. Thackray, and S.J. Dorsch (2006). Analysis of LiDAR-derived topographic information for characterizing and differentiating landslide morphology and activity. *Geomorphology*, 73(1), 131-148.
- Guthrie, R.H., A. Hockin, L. Colquhoun, T. Nagy, S.G. Evans, and C. Ayles (2010). An examination of controls of debris flow mobility: evidence from coastal British Columbia. *Geomorphology* 114, 601–613.
- Hall, D.E.; M.T. Long, M.D. Remboldt (Eds.); R.W. Prellwitz, T.E. Koler; J.E Steward (coordinators) (1994). *Slope Stability Reference Guide for National Forests in the United States*. Publication EM-7170-13. Washington, DC: U.S. Department of Agriculture, U.S. Forest Service, Engineering Staff. 3 volumes, 1091 p.
- Handwerger, A.L., J.J. Roering, and D.A. Schmidt (2013). Controls on the seasonal deformation of slow-moving landslides, *Earth and Planetary Science Letters*.
- Hanks, R.J. and G.L. Ashcroft (1980). *Applied Soil Physics*. Advanced Series in Agricultural Sciences 8, New York: Springer Verlag.
- Harbaugh, A.W., E.R. Banta, M.C. Hill, and M.G. McDonald (2000). MODFLOW-2000, the U.S. Geological Survey modular ground-water model – The Ground-Water Flow Process: U.S. Geological Survey.
- Harp, E. L., A.F. Chleborad, R.L. Schuster, M.E. Reid, and R.C. Wilson (1997). Landslides and landslide hazards in Washington state due to the February 5-9, 1996 storm; U.S. Geological Survey Administrative Report, 29.
- Haugerud, R. A., D.J. Harding, S.Y. Johnson, J.L. Harless, C.S. Weaver, and B.I. Sherrod (2003). High resolution Lidar topography of the Puget Lowland, Washington: A bonanza for earth science. *Geological Society Today*, 13(6), 4-10.
- Haugerud, R.A. (2014). Preliminary interpretation of pre-2014 landslide deposits in the vicinity of Oso, Washington: U.S. Geological Survey Open-File Report 2014–1065, 4.
- Heusser, C.J. (1973). Environmental sequence following the Fraser advance of the Juan de Fuca lobe, Washington. *Quaternary Research*, 3(2), 284-306.
- Highland, L.M. and P. Bobrowsky (2008). *The landslide handbook; A guide to understanding landslides*. Reston, Virginia, U.S. Geological Survey Circular, 1325, 129.
- Horel, G. (2007). Overview-level landslide runout study: Western Forest Products Inc., Tree Farm Licence 6. *Streamline Watershed Management Bulletin*, 10, 15–24.
- Hungr, O., G.C. Morgan, and R. Kellerhals (1984). Quantitative analysis of debris torrent hazards for design of remedial measures. *Can. Geotech. J.* 21, 663-676.

- Hungr, O. (1995). A model for the runout analysis of rapid flow slides, debris flows and avalanches. *Canadian Geotechnical Journal*, 32(4):610-623. <http://www.clara-w.com/DAN-W-Manual-Rel-10.pdf>
- Hungr, O., S. Evans, M.J. Bovis, and J.N. Hutchinson (2001). A review of the classification of landslides of the flow type. *Environmental and Engineering Geoscience*, 7, 221-238.
- Hungr, O., J. Corominas, and E. Eherhardt (2005). Estimating landslide motion mechanism, travel distance and velocity. IN *Landslide Risk Management*.
- Hungr, O., S. Leroueil and L. Picarelli (2014). The Varnes classification of landslide types, an update. *Landslides*, 11(2),167-194.
- Hunter, G. and R. Fell (2003). Travel distance angle for “rapid” landslides in constructed and natural soil slopes. *Canadian Geotechnical Journal*, 40(6):1123-1141.
- Iverson, R. M. and M. E. Reid. (1992). Gravity-driven groundwater flow and slope failure potential 1. Elastic Effective-Stress Model. *Water Resources Research*, 28(3), 925-938.
- Iverson, R.M. and M.E. Reid (1992). Gravity-driven groundwater flow and slope failure potential 2. Effects of slope morphology, material properties, and hydraulic heterogeneity. *Water Resources Research*, 28(3), 939-950.
- Jassal, R. S., T.A. Black, D.L. Spittlehouse, C. Brümmer, and Z. Nestic (2009). Evapotranspiration and water use efficiency in different-aged Pacific Northwest Douglas-fir stands. *Agricultural and Forest Meteorology*, 149(6), 1168-1178
- Johnson, A. C. (1991). Effects of landslide-dam-break floods on channel morphology, Timber Fish Wildlife Report SH17-91-001, 90.
- Keaton, J.R. and J.V. DeGraff (1996). Surface observation and geologic mapping. IN: Turner, A.K., Schuster, R.L. (Eds.), *Landslides - Investigation and Mitigation*. National Academy Press; National Research Council Transportation Research Board Special Report 247, 36-75.
- Keaton, J. R., J. Wartman, S. Anderson, J. Benoit, J. DeLaChapelle, R. Gilbert, and D.R. Montgomery (2014). Geotechnical Extreme Events Reconnaissance (GEER) Steering Committee. The 22 March 2014 Oso Landslide, Snohomish County, Washington. *Geomorphology*, 253, 275-288.
- Keefer, D. K. and A.M. Johnson (1983). *Earthflows: Morphology, mobilization and movement*, U.S. Geologic Survey Professional Paper 1256, United States Government Printing Office, Washington, D.C.
- Kelsey, Harvey M. (1988) Formation of inner gorges. *Catena*, 15(5), 433-458.
- Koloski, J.W., S.D. Schwarz, D.W. Tubbs (1989). Geotechnical Properties of Geologic Materials, IN: *Engineering Geology in Washington*, Washington Division of Geology and Earth Resources, Bulletin 78(1) 19-26.

- Krogstad, F. and M. O’Conner (1997). Mass water. IN: Simpson Timber Company; Washington Department of Natural Resources, South Fork Skokomish watershed analysis: Washington Department of Natural Resources, Appendix A (unpaginated).
- Lancaster, S.T., S.K. Hayes, and G. Grant (2003). Effects of wood on debris flow runout in a small mountain watershed. *Water Resources Research*, 39(6), 1168.
- Leavesley, G.H., R.W. Lichty, B.M. Troutman, and L.G. Saindon (1983). Precipitation-runoff modeling system-users manual. U.S. Geological Survey Water Resources Investigation Report. 83-4238.
- Liang, X., D.P. Lettenmaier, E.F. Wood, and S.J. Burges (1994). A simple hydrologically based model of land surface water and energy fluxes for general circulation models. *Journal of Geophysical Research*, 99(D7), 14415-14428.
- Link, T. E., M. Unsworth, and D. Marks (2004). The dynamics of rainfall interception by a seasonal temperate rainforest. *Agricultural and Forest Meteorology*, 124(3), 171-191.
- Liu, X. (2008). Airborne LiDAR for DEM generation: Some critical issues. *Progress in Physical Geography*, 32(1), 31-49.
- Mackey, B.H. and J.J. Roering (2011). Sediment yield, spatial characteristics, and the long-term evolution of active earthflows determined from airborne lidar and historical aerial photographs, Eel River, California. *Geological Society of America Bulletin*, 123, 1560-1576.
- Martin, T. A., K.J. Brown, J. Cermak, R. Ceulemans, J. Kucera, F.C. Meinzer, J.S. Rombold, D.G. Sprugel, and T.M. Hinkley (1997). Crown conductance and tree and stand transpiration in a second-growth *Abies amabilis* forest. *Canadian Journal of Forest Research*, 27(6), 797-808.
- May, C. L. (2002). Debris flows through different forest age classes in the central Oregon Coast Range. *Journal of the American Water Resources Association* 38:1097–1113.
- May, C. L. and R.E. Gresswell (2004). Spatial and temporal patterns of debris flow deposition in the Oregon Coast Range, USA. *Geomorphology* 57: 135-149.
- McGuffey, V. C., V.A. Modeer, A.K. Turner (1996). Subsurface exploration. IN: Turner, A. K. and R.L. Schuster (Eds.), *Landslides - Investigation and Mitigation*. National Academy Press; National Research Council Transportation Research Board Special Report 247, 231-277.
- McGuffey, V.C., V.A. Modeer, Jr., and A. Keith Turner (1996). Surface Exploration. IN: Turner, A. K. and R.L. Schuster (Eds.), *Landslides - Investigation and Mitigation*. National Academy Press; National Research Council Transportation Research Board Special Report 247, 231.
- McKean, J. and J. Roering (2004). Objective landslide detection and surface morphology mapping using high-resolution airborne laser altimetry, *Geomorphology*, 57(3-4), 331-351.

- Melton, M.A. (1965). The geomorphic and paleoclimactic significance of alluvial deposits in southern Arizona. *Journal of Geology*, 73, 1-38.
- Montgomery, D.R., K.M. Schmidt, H.M. Greenberg, and W.E. Dietrich (2000). Forest clearing and regional landsliding. *Geology*, 28(4) 311-315.
- Moore, R. and S.M. Wondzell (2005). Physical hydrology and the effects of forest harvesting in the Pacific Northwest: A Review.
- ODF Technical Note 2. Oregon Department of Forestry (2003). High Landslide Hazard Locations, Shallow, Rapidly Moving Landslides and Public Safety: Screening and Practices. Forest Practices Technical Note Number 2, Version 2.0.
- ODF Technical Note 6. Oregon Department of Forestry (2003). Determination of Rapidly Moving Landslide Impact Rating. Forest Practices Technical Note No. 6, Version 1.0.
- Pierson, T.C. and K.M. Scott (1985). Downstream dilution of a lahar: Transition from debris flow to hyper-concentrated streamflow. *Water Resources Research*, 21(10), 1511-1524.
- Pirulli, M. A., W. Preh, C. Ruth, C. Scavia, and R. Poisel (2003). Rock avalanche run out prediction: Combined application of two numerical methods. In *Proceedings of the International Symposium on Rock Mechanics*, South Africa Institute of Mining and Metallurgy, Johannesburg, pp. 903-908.
- Prochaska, A. B., P.M. Santi, J. Higgins, and S.H. Cannon (2008). Debris-flow runout predictions based on the average channel slope (ACS). *Engineering Geology* 98:29-40.
- Prellwitz, R. W., J.E. Steward, D.E. Hall, T.E. Koler, M.D. Remboldt, and M.T. Long (1994). Slope stability reference guide for national forests in the United States. Washington, DC: U.S. Dept. of Agriculture, Forest Service, 3 1091.
- Ramirez. J.A. and S.U. Senarath (2000). A Statistical-dynamical parameterization of interception and land surface-atmosphere interactions. *Journal of Climate*, 13, 4050-4063.
- Revellino, P., O. Hungr, F.M. Guadagno, and S.J. Evans (2004). Velocity and run out simulation of destructive debris avalanches in pyroclastic deposits, Campania region, Italy. *Environmental Geology*, 45, 295-311.
- Reeves, G.H., L.E. Benda, K.M. Burnett, P.A. Bisson, and R. Sedell (1995). A disturbance based ecosystem approach to maintaining and restoring freshwater habitats of evolutionarily significant units of anadromous salmonids in the Pacific Northwest. IN: Nielsen, J.L. (Ed.), *Evolution and the Aquatic System: Defining Unique Units in Population Conservation*, American Fisheries Society Symposium 17, Bethesda, MD, USA, 334-349.
- Restrepo, C., L.R. Walker, A.B. Shiels, R. Bussman, L. Claessens, S. Fisch, P. Lozano, G. Negi, L. Paolini, G. Poveda, C. Ramos-Scharro', M. Richter, and E. Vela'quez (2009). Landsliding and its multiscale influence on mountainscapes. *BioScience*, 59, 685-698.

- Robison, E.G., K. Mills, J. Paul, L. Dent, and A. Skaugset (1999). Storm impacts and Landslides of 1996: Final Report. Forest Practices Technical Report, Vol. 4, Oregon Department of Forestry, Salem, OR, USA, 145.
- Roering, J. J., J.W. Kirchner, and W.E Dietrich (2005). Characterizing structural and lithologic controls on deep-seated landsliding: Implications for topographic relief and landscape evolution in the Oregon Coast Range, USA. *Geological Society of America Bulletin*, 117(5-6), 654-668.
- Roering, J.J., L.L. Stimely, B.H. Mackey, and D.A. Schmidt (2009). Using DInSAR, airborne lidar, and archival air photos to quantify landsliding and sediment transport. *Geophysical Research Letters*, 36(19), L19402.
- Roering, J.J., B.H. Mackey, J.A. Marshall, K.E. Sweeney, N.I. Deligne, A.M. Booth, A.L. Handwerker, and C. Cerovski-Darriau (2013). You are HERE: connecting the dots with airborne lidar for geomorphic fieldwork. *Geomorphology* 200(1), 172-183.
- Scanlon, B.R., R.W. Healy, and P.G. Cook (2002). Choosing appropriate techniques for quantifying groundwater recharge, *Hydrogeology Journal*, 10, 18-39.
- Scheidl, C. and D. Rickenmann (2010). Empirical prediction of debris-flow mobility and deposition on fans. *Earth Surface Processes and Landforms*, 35, 157-173.
- Scheingross, J.S., B. Minchew, B.H. Mackey, M. Simons, M.P. Lamb, and S. Hensley (2013). Fault zone controls on the spatial distribution of slow moving landslides, *Geological Society of America Bulletin*, 125, 473-489.
- Schulz, W. H. (2005). Landslide susceptibility estimated from mapping using light detection and ranging (LiDAR) imagery and historical landslide records, Seattle, Washington, U.S. Geological Survey, Open-File Report 2005-1405.
- Schulz, W. H. (2007). Landslide susceptibility revealed by LiDAR imagery and historical records, Seattle, Washington. *Engineering Geology*, 89(1), 67-87.
- Schuster, R. L. and G.F. Wieczorek (2002). Landslide triggers and types. IN: *Landslides: proceedings of the first European conference on landslides*, Taylor and Francis, Prague. 59-78.
- Sharpe, C.F. (1938). *Landslides and related phenomena: A study of mass movement of soil and rock*. New York: Columbia University Press.
- Shu, H. P., D.F. Liu, L.M. Tian, J.Z. Ma, and G. Wang (2014). Study of the Dynamic Characteristics of Landslides Based on the Dan-W Model. *Advanced Materials Research*, Vols. 1073-1076, 1567-1573.

- Sias, J. (2003). Estimation of Multi-season Evapotranspiration in Relation to Vegetation Cover for Regions with Rainy-winter/dry-summer Climate. Washington State Department of Natural Resources.
- Sidle, R.C. and H. Ochiai (2006). Landslides: Processes, prediction, and land use. American Geophysical Union and Water Resources Monograph, 18, 312.
- Sidle, R.C., A.J. Pearce, and L. O'Loughlin (1985). Hillslope stability and land use. American Geophysical Union Water Resources Monograph 11, 140.
- Simpson, D. G. (2000). Water use of interior Douglas-fir. Canadian Journal of Forest Research, 30(4), 534-547.
- Tabor, R.W. and W.M. Cady (1978). Geologic map of the Olympic Peninsula, Washington, U.S. Geological Survey Miscellaneous Investigation Series MAP I-994.
- Tabor, R.W., V.A. Frizzell, J.T. Whetten, R.B. Waitt, D.A. Swanson, G.R. Byerly, D.B. Booth, M.J. Hetherington, and R.E. Zartman (1987). Geologic map of the Chelan 30-minute by 60-minute quadrangle, Washington, U.S. Geological Survey Miscellaneous Series Map I-1661.
- Tarolli, P. (2014). High-resolution topography for understanding Earth surface processes: Opportunities and challenges. *Geomorphology* 216, 295-312.
- Tarolli, P., G. Sofia, and G. Dalla Fontana (2012). Geomorphic features extraction from high resolution topography: landslide crowns and bank erosion. *Natural Hazards*, 61, 65-83.
- Terzaghi, K. (1951). Mechanism of landslides. Harvard University, Department of Engineering.
- Thorsen, G.W. (1989). Landslide provinces in Washington, IN: Engineering Geology in Washington, Washington Division of Geology and Earth Resources, Bulletin 78, 71-89.
- Thorsen, R.M. (1980). Ice sheet glaciation of the Puget Lowland during the Vashon Stage (late Pleistocene). *Quaternary Research* 13, 303-321.
- Travelletti, J. and J.P. Malet (2012). Characterization of the 3D geometry of flow-like landslides: a methodology based on the integration of heterogeneous multi-source data. *Engineering Geology*, 128, 30-48.
- Tubbs, D.W. (1974). Landslides in Seattle. Information Circular 52, Washington Division of Geology and Earth Resources, Washington Department of Natural Resources, Olympia, Washington.
- Turner, A. Keith and Verne C. McGuffey (1996). Organization of Investigation Process. IN: Turner, A. Keith and Robert L. Schuster (Eds.), *Landslides--Investigation and mitigation*. National Academy Press; National Research Council Transportation Research Board Special Report 247, 121-128.

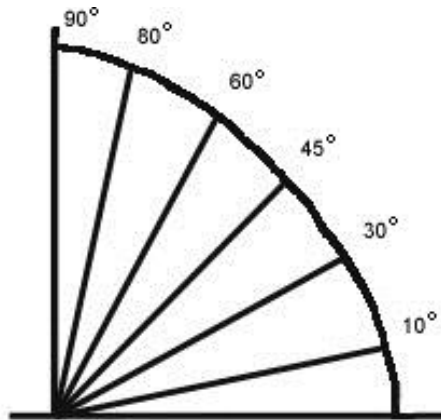
- Turner, A. Keith and Robert L. Schuster (Eds.) (1996). Landslides--Investigation and mitigation. National Academy Press; National Research Council Transportation Research Board Special Report 247.
- Turner, T.R., S.D. Duke, B.R. Fransen, M.L. Reiter, A.J. Kroll, J.W. Ward, J.L. Bach, T.E. Justice, and R.E. Bilby, R.E. (2010). Landslide densities associated with rainfall, stand age, and topography on forested landscapes, southwestern Washington, USA. *Forest Ecology and Management* 259, 2233-2247.
- University of Colorado, Geography Department. A model of hydrologic processes on a hillslope, University of Colorado, Boulder, CO. Web:  
[http://snobear.colorado.edu/IntroHydro/geog\\_hydro.html](http://snobear.colorado.edu/IntroHydro/geog_hydro.html).
- U.S. Geological Survey (2004). Landslide Types and Processes, Fact Sheet 2004-3072.
- U.S. Geological Survey (2007). Digital Mapping Techniques, Open-File Report 2008-1385.
- Vaccaro, J.J., A.J. Hansen, Jr., and M.A. Jones (1998), Hydrogeologic framework of the Puget Sound aquifer system, Washington and British Columbia. Regional Aquifer-System Analysis-Puget-Willamette Lowland. U.S. Geological Survey Professional Paper 1424-D, 77.
- van Asch, T. W. J. (2005). Modelling the hysteresis in the velocity pattern of slow-moving earth flows: the role of excess pore pressure. *Earth Surface Processes and Landforms*, 30(4), 403-411.
- van Asch, T. W., L.P.H. Van Beek, and T.A. Bogaard (2009). The diversity in hydrological triggering systems of landslides. IN: Proceedings of the First Italian Workshop on Landslides, 8-10.
- van Asch, T. W., J.P. Malet, and T.A. Bogaard (2009). The effect of groundwater fluctuations on the velocity pattern of slow-moving landslides. *Natural Hazards Earth System Science*, 9, 739-749.
- Van Den Eeckhaut, M., N. Kerle, J. Poesen, and J. Hervás (2012). Object-oriented identification of forested landslides with derivatives of single pulse lidar data. *Geomorphology* 173, 30–42.
- Van Den Eeckhaut, M., J. Poesen, G. Verstraeten, V. Vanacker, J. Nyssen, J. Moeyersons, L.P.H. Van Beek, and L. Vandekerckhove (2007). Use of LiDAR-derived images for mapping old landslides under forest, *Earth Surface Processes and Landforms*, 32(5), 754-769.
- VanDine, D. F. (1996). Debris flow control structures for forest engineering. B.C. Min. For., Working Paper 22/1996.
- Varnes, D. J. (1978). Slope movement types and processes. In Special Report 176: Landslides: Analysis and Control, Schuster and, R.L., Krisek, R.J. (Eds.), TRB, National Research Council, Washington, D. C., 11-33.

- Weyerhaeuser Timber Company (1993). Tolt Watershed Analysis, Mass Wasting Prescription Methodology, 98-103 and figures 1-4 (unpaginated). See Washington Department of Natural Resources at <https://fortress.wa.gov/dnr/protectiosa/ApprovedWatershedAnalyses>.
- Washington State Department of Emergency Management. (2013) Washington State Enhanced State Hazard Mitigation Plan.
- Wegmann, K.W. (2003). Digital landslide inventory for the Cowlitz County urban corridor – Kelso to Woodland (Coweeman River to Lewis River), Cowlitz County, Washington, DNR Division of Geology and Earth Resources, Report of Investigations 34, 24.
- Whitmeyer, S.J., J. Nicoletti, and J. Madison (2010). The digital revolution in geologic mapping, *Geological Society Today*, 20(4/5), 4-10.
- Wigmosta, M. S., B. Nijssen, P. Storck, and D.P. Lettenmaier (2002). The distributed hydrology soil vegetation model. *Mathematical models of small watershed hydrology and applications*, 7-42.
- Williamson, D. A. (1994). Geotechnical exploration–drive probe method. DE Hall, MT Long, and MD Remboldt, editors. *Slope Stability Guide for National Forests in the United States*. USDA Forest Service, Washington Office Engineering Staff Publication EM 7170-13, Washington, DC, 317-321.
- Ziemer, R. R. (1979). Evaporation and transpiration. *Reviews of Geophysics and Space Physics*, 17 (6), 1175-1186.



**APPENDIX A – MEASUREMENTS OF SLOPE GRADIENTS**

The forest practices rules contain specific slopes gradients (degrees and percent) for potentially unstable slope or landform descriptions. Slope gradients are commonly expressed in two different but related ways, as degrees of arc or percent rise to run. It is important to understand the relationships between them.

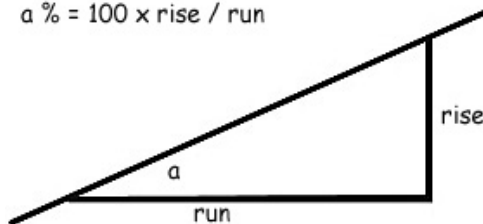


*Angles in degrees.*

**Degrees**

A circle is divided into 360 degrees of arc. Each degree is further divided into 60 minutes (60'), and each minute into 60 seconds (60"). The quadrant of the circle between a horizontal line and a vertical line comprises 90 degrees of arc.

$$\alpha \% = 100 \times \text{rise} / \text{run}$$



*Angles in percent.*

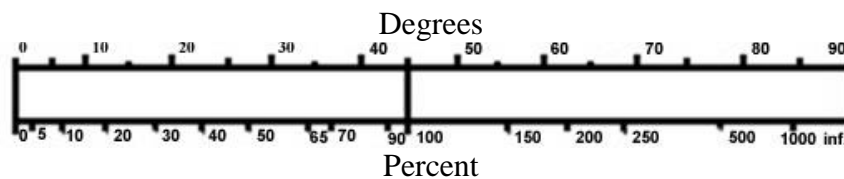
**Percent**

The horizontal distance between two points (distance between the points on a map) is called the run. The vertical distance (difference in elevation) is called the rise. The gradient can be expressed as the ratio of rise divided by run, a fraction that is the tangent of angle α. When multiplied by 100, this fraction is the percent slope.

**Relationship of Degrees to Percent**

Because of the differences in the ways they are calculated, each of these two slope measurements is better for certain applications. Because it is more precise at gentle slopes, percent is best for measuring and expressing small angles, such as the gradients of larger streams. However, for steeper slopes, the constant angular difference and smaller numbers (e.g., 85 degrees = 1143% slope) make degrees more useful.

The figure below shows approximate equivalences for gradients expressed in degrees and percent. Note that there is a rough 2:1 ratio in the 30 to 40 degree range (e.g., 35 degrees = 70% slope), conversely this relationship changes dramatically at gentler and steeper angles.



*Slope gradients in degrees and percent.*

## APPENDIX B – LANDSLIDE PROVINCES IN WASHINGTON

Landsliding is a widespread geomorphic process which actively modifies the varied topography and diverse underlying geologic materials present throughout Washington State. This overview focuses on areas within the state where forest practices activities are prevalent and draws from Thorsen's (1989) organization and discussion by physiographic provinces.

### **Puget Lowlands-North Cascade Foothills**

This region has been extensively modified by the continental, and to a lesser extent, alpine glaciations. Unconsolidated sediments formed by glaciation include thick layers of fine-grained glacial lake sediments (fine sand, silt, and clay), coarse-grained outwash (sand, gravel, cobbles, and boulders), and till. Much of these sediments are very compact, having been overridden by thousands of feet of ice. Groundwater systems are complex and often vertically and laterally discontinuous within these deposits. Perched and confined aquifers are commonly present above and between fine-grained aquitards. Glacial meltwater and subsequent river and marine erosion have left oversteepened slopes on the margins of river valleys and marine shoreline, which are often highly susceptible to a great variety of landslide types. Falls and topples are common on near-vertical exposures of these sediments. Translational landslides controlled by bedding surfaces and rotational failures that cross-cut bedding are widespread and can be very large. They initiate rapidly or reactivate episodically. Debris flows can reoccur within steep drainages incised in these deposits. Translational and complex landslides occur within some of the very weak bedrock units exposed within the foothills and lowlands, such as the Chuckanut Formation, Darrington Phyllite, and Puget Group rocks.

### **Olympic Peninsula**

Somewhat similar geologic materials are present on the Olympic Peninsula. The lowlands and major river valleys are underlain by sediments derived by both continental and alpine glaciations, which are in turn underlain by very weak sedimentary and volcanic rocks. Large landslide complexes, predominantly in glacial sediments, are widespread along Hood Canal and lower reaches of the Quinault, Queets, Hoh, and Bogachiel valleys. Large rock slides and rock avalanches are common in the steep upper reaches of Olympic mountain drainages. Translational landslides and large landslide complexes are also abundant in the very weak marine sedimentary rocks (often occurring along inclined bedding surfaces) and mantling residual soils in the western and northwestern portions of the Peninsula, such as the Twin Creek Formation, and the Western Olympic and Hoh Lithic Assemblages.<sup>97</sup> Debris flows and avalanches are often generated in steeper drainages and slopes.

### **Southwest Washington**

The Willapa Hills of Southwest Washington are comprised primarily of very weak marine sedimentary and volcanic rocks. Because the region has not been glaciated, thick and especially weak residual soils have developed on these rocks. Translational landslides and coalescing landslides forming earthflows are widespread in these weak rocks and overlying soils, such as in the Lincoln Creek Formation.<sup>98</sup> Thick, deeply weathered loess deposits are sources for shallow landslides, debris flows, and avalanches.<sup>99</sup> These deposits are prevalent along the lower Columbia

---

<sup>97</sup> Tabor and Cady 1978; Badger 1993.

<sup>98</sup> Gerstel and Badger 2002.

<sup>99</sup> Thorsen 1989.

River valley, as well as other areas where colluvial deposits have accumulated on slopes and in drainages underlain by strong and relatively unweathered rock.

### **Cascade Range**

The Cascade Range is generally divided on the basis of rock types into northern and southern provinces occurring geographically in the vicinity of Snoqualmie Pass. Strong crystalline rocks intensely scoured by alpine glaciations occur to the north. Weaker volcanic flows, typically pyroclastic and volcanoclastic rocks occur to the south, much of which was beyond the reach of the last continental glaciation. Rock falls and complex rock slides are dominant in the steep bedrock slopes in the North Cascades. In the South Cascades and Columbia Gorge, weak interbeds control large translational failures in the Chumstick and Roslyn Formations<sup>100</sup>, the Columbia River Basalts and other volcanic flow rocks, and Cowlitz Formation and Sandy River Mudstone<sup>101</sup>. Shallow landslides generating debris avalanches and flows are common on steep slopes and drainages.

### **Okanogan Highlands**

Pleistocene glacial sediments that mantle the mostly crystalline core of the Okanogan Highlands are prone to both shallow and deep-seated landslides. The debris flows in this region can be a hazard during intense thunderstorms, usually moving through the area during late spring to late summer. Deep-seated landslides are most common in the areas surrounding Lake Roosevelt and landslide movement usually occurs in areas where relict to dormant deep-seated landslides exist. Rock falls and rock slides are common from the many steep bedrock exposures in the region.

### **Columbia Basin**

This province is largely composed of thick sequences of lava flows known as the Columbia River Basalts. Catastrophic flood events scoured the soils and a portion of the bedrock in much of this region before re-depositing it in watersheds along the edges of the main floodway. Landslides include slope failures in bedrock along the soil interbeds and in the overlying flood sediments and loess deposits. Bedrock slope failures are most common in the form of very large deep-seated translational landslides, deep-seated slumps or earth flows. The Blue Mountains in southeastern Washington also have experienced recurring and widespread shallow landsliding and debris flows related to storm events.<sup>102</sup>

---

<sup>100</sup> Tabor et al. 1987.

<sup>101</sup> Wegmann 2003.

<sup>102</sup> Harp et al. 1997.

## APPENDIX C – MAPS AND SURVEYS

Map and survey data resources available to the qualified expert include:

### *Multi-disciplinary map and survey data resources:*

- Washington State Geologic Information Portal – print custom digital maps of Washington State or download map data for GIS applications; includes a variety of base layer selections with interactive Geologic Map, Seismic Scenarios Catalog, Natural Hazards, Geothermal Resources, Subsurface Geology Information, and Earth Resource Permit Locations. Available on the DNR website.
- Forest Practices Application Mapping Tool – online mapping tool with a variety of digital map base layer selections including topography, surface water (streams, water bodies, wetlands), soils, transportation network, soil site class, and potential slope instability (designed for shallow landslide susceptibility mapping only). Available on the DNR website.
- County interactive GIS map viewers – print custom digital maps with some combination of the following data: topography (LiDAR and/or U.S. Geological Survey (USGS) DEM), surface water, soils, wetlands, sensitive areas, 100-year floodplain designations, transportation systems, property ownership and structure location. Available online at select county websites (e.g., King County iMAP).
- Washington State Coastal Atlas Map – interactive map utility for shoreline areas with multiple data layers including shoreline geomorphology (coastal slope stability and landforms), biology (plant communities), land and canopy cover, beaches and shoreline modifications, wetlands and estuaries, historic shoreline planforms, assessed waters, and Shoreline Management Act designations. Available on Department of Ecology’s website.
- DNR surface mining permits.

### *Topographic maps:*

- USGS topographic 7.5 minute quadrangle maps. Available from a number of government and non-government online vendors and free downloadable websites.
- LiDAR-based topographic maps (LiDAR-derived DEM), typically 1- to 3-meter resolution; see Appendix E for LiDAR map and data sources.

### *Geologic maps:*

- Geologic maps of various scales, in print and compiled by DNR, Division of Geology and Earth Resources as Map Series, Open File Reports, Bulletins, and Information Circulars; see most recent “Publications of the Washington Division of Geology and Earth Resources”; this publication and a status map of 7.5 minute quadrangle geologic mapping efforts (USGS STATEMAP program) are available on the Division of Geology and Earth Resources website with links to online publications where available.
- Geologic maps, various scales, out-of-print or historic; all sources including dissertations and theses. See catalog of the Washington Geology Library, available on the DNR website with links to online publications where available.
- Geology digital data; small-scale geology coverage in ArcGIS shapefile format, available on the Division of Geology and Earth Resources website.
- Geologic maps, various scales, available via The National Geologic Map Database (NGMDB); compiled by USGS and Association of American State Geologists. Available on the NGMDB website (catalog) and USGS Online Store (paper and digital copies).

*Geologic hazards and landslide inventory maps:*

- Washington State Geologic Information Portal, referenced previously.
- Landslide Hazard Zonation (LHZ) Project – mapped existing and potential deep-seated landslides and landforms in select watersheds; hazard classifications provided with supporting documentation for completed projects. Available on the DNR website.
- Landslide inventory and Mass Wasting Map Unit – various maps contained in Watershed Analysis reports prepared under chapter 222-22 WAC; mapped landslides (including deep-seated and earthflows) for select Watershed Administrative Units (WAU); Adobe pdf versions of DNR-approved Watershed Analysis Reports are available through the DNR website.
- Modeled slope stability morphology (SLPSTAB, SHALSTAB, SINMAP) output maps.
- U.S. Forest Service watershed analyses – available from U.S. Forest Service offices for select watersheds; some documents and maps are available online.
- Washington State tribal watershed analyses – available from tribal agency offices; some documents and maps are available online.
- Washington State Coastal Atlas Map – slope stability maps developed prior to 1980, based on aerial photography, geologic mapping, USGS topographic quadrangle map, and field observations. Maps have not been updated with landslide data since 1980 but are used currently in land-use planning and in the Department of Ecology interactive Coastal Map tool; data limitations available on Department of Ecology’s website.
- Qualified expert reports on deep-seated landslides, for select timber harvest units or other forest management projects regulated by the Washington Forest Practices Act. Often contain mapped landslides.
- TerrainWorks (NetMap) – provides digital landscape and analysis tools for slopes stability data/analysis and risk assessments.

*Soil surveys:*

- Natural Resources Conservation Service (NRCS) soil survey maps and data – online soil survey, map and database service; historical soil survey publications (CD or paper copies); NRCS website administered through the U.S. Department of Agriculture.
- Geochemical and mineralogical soil survey map and data – USGS Mineral Resources Program, open-file report available online (Smith et al., 2013) in Adobe pdf.

## APPENDIX D – EARTH IMAGERY AND PHOTOGRAMMETRY

The most common sources of imagery for landslide and landform identification, mapping, and photogrammetric analysis include:

- Aerial photography – historic and recent aerial photos produced in color or black and white and taken at various altitudes (typical scales in the 1:12,000 to 1:60,000 range). Aerial photos acquired by the Natural Resource Conservation Service (NRCS) are available in some areas as early as the 1930s. Multiple flight years are required for chronologically reconstructing deep-seated landslide activity and developing time-constrained landslide inventories. Forest landowners typically purchased photos from regional vendors on a 2 to 10 year cycle until recently when other freely acquired imagery became available (e.g., Google Earth, ESRI World Imagery). Stereo-pair photos are highly valued for landslide detection and reconstruction because they allow stereoscopic projection in three dimensions and can display high-quality feature contrast and sharpness;
- Google Earth – map and geographic information program with earth surface images created by superimposing satellite imagery (DEM data collected by NASA’s Shuttle Radar Topography Mission), aerial photos, and GIS three dimensional (3D) globe. Ortho-rectified, generally 1-meter resolution, 3D images are available for multiple years (Historical Imagery tool), allowing chronologic deep-seated landslide mapping. Google Earth supports desktop and mobile applications, including managing 3D geospatial data;
- Bing Maps Aerial View – part of Microsoft web mapping service; overlays topographic base maps with satellite imagery taken every few years.
- ESRI World Imagery – ArcGIS online image service utilizing LandSat imagery based on the USGS Global Land Survey datasets and other satellite imagery, with onboard visualization, processing, and analysis tools that allow imagery integration directly into all ArcGIS projects. Requires ArcGIS capability;
- NAIP (National Agriculture Imagery Program) aerial imagery – ortho-rectified, generally 1-meter resolution earth surface images taken annually during peak growing season (“leaf-on”), acquired by digital sensors as a four color-band product that can be viewed as a natural color or color infrared image. The latter are particularly useful for vegetation analysis. Data available to the public via the USDA Geospatial Data Gateway and free APFO viewing software, as well as through ESRI for ArcGIS applications;
- Washington State Coastal Atlas Map and Photos – oblique shoreline photos spanning 1976-2007; part of an interactive map tool at Department of Ecology’s website;
- United States Geological Survey EarthExplorer (<http://earthexplorer.usgs.gov/>) archive of downloadable aerial photos.

## APPENDIX E – LiDAR: PROCESSING, APPLICATIONS, AND DATA SOURCES

LiDAR is a remote sensing technique that involves scanning the earth's surface with an aircraft-mounted laser in order to generate a three-dimensional topographic model.<sup>103</sup> During a LiDAR acquisition flight, the aircraft's trajectory and orientation are recorded with Global Positioning System (GPS) measurements and the aircraft's inertial measurement unit, respectively. Throughout the flight, the laser sends thousands of pulses per second in a sweeping pattern beneath the aircraft. Energy from a single pulse is commonly reflected by multiple objects within the laser's footprint at ground level, such as the branches of a tree and the bare ground below, generating multiple returns. The first returns are commonly referred to as "highest hit" or "top surface" points and are used to measure the elevations of vegetation and buildings, while the last returns are commonly referred to as "bare earth" points and undergo additional processing to create a model of the earth's ground surface.

To generate a DEM, the aircraft trajectory and orientation measurements are combined with the laser orientation and travel time data to create a geo-referenced point cloud representing the location of each reflected pulse. These irregularly spaced points are commonly interpolated to a regularly spaced grid with horizontal spacing on the order of 1 meter to create a high resolution digital elevation model. Bare earth digital elevation models undergo additional filtering to identify ground returns from the last return point cloud data.<sup>104</sup> These bare earth DEMs are most commonly used for interpreting and mapping deep-seated landslide features, especially in forested terrain where vegetation would normally obscure diagnostic ground features.<sup>105</sup>

Repeat LiDAR acquisitions of a site are becoming more common. This allows the qualified expert to review more than a single LiDAR data set to interpret deep-seated landslide morphology; instead they can measure topographic changes related to slope instability with pairs of LiDAR scenes.<sup>106</sup> Vertical changes can be measured by differencing LiDAR-derived DEMs, while manual or automated tracking of features visible on hillshade or slope maps between scenes can be used to estimate horizontal displacements. Note that many active deep-seated landslides move at rates that may be undetectable given the uncertainties in the LiDAR data, so this technique is most helpful for relatively large topographic changes, typically on the order of several meters.<sup>107</sup> Care should be taken to precisely align the repeat LiDAR DEMs.

New remote sensing techniques for terrain characterization are being developed at a rapid pace, due in part to the expanding availability of publicly acquired, high-resolution topographic data. For example, major advances in deep-seated landslide characterization methods are combining high-resolution LiDAR data with other remotely sensed information and developing quantitative LiDAR analysis techniques to map and quantify landslide movement.<sup>108</sup> Examples include using LiDAR-derived Digital Elevation Models (DEM) and Digital Terrain Models (DTM) with: (1) radar data (for example infrared or InSar) and historical aerial photographs to quantify deep-seated landslide

---

<sup>103</sup> Carter et al. 2001.

<sup>104</sup> For a review of filtering techniques, see Liu 2008.

<sup>105</sup> Van Den Eeckhaut et al. 2007.

<sup>106</sup> Corsini et al. 2007; Delong et al. 2012; Daehne and Corsini 2013.

<sup>107</sup> Burns et al. 2010.

<sup>108</sup> Tarolli 2014.

displacement and sediment transport<sup>109</sup>; (2) ortho-rectified historical aerial photographs to map earthflow movement and calculate sediment flux<sup>110</sup>; (3) GIS-based algorithms for LiDAR derivatives (e.g., hillslope gradient, curvature, surface roughness) to delineate and inventory deep-seated landslides and earthflows<sup>111</sup>; and (4) subsurface investigations<sup>112</sup>.

Sources for viewing and downloading airborne LiDAR of Washington State include the following (URLs may change without notice):

- King County iMAP: Interactive mapping tool (<http://www.kingcounty.gov/operations/GIS/Maps/iMAP.aspx>) – Displays shaded relief maps derived from LiDAR data at locations where it is available. LiDAR data have been filtered to remove vegetation and manmade structures and can be overlain with a wide range of additional maps relating to county infrastructure, property, hydrographic features, and planning.
- National Oceanic and Atmospheric Administration Digital Coast (<http://csc.noaa.gov/digitalcoast/>) – Archive of downloadable LiDAR data focused on coasts, rivers, and lowlands. Options for downloading point cloud, gridded, or contour data that require geographic information system software such as ArcGIS to view and analyze.
- National Science Foundation Open Topography facility (<http://www.opentopography.org/index.php>) – Archive of downloadable LiDAR data collected the National Center for Airborne Laser Mapping (NCALM) for research projects funded by the National Science Foundation. Options for downloading point cloud or gridded data for use with geographical information system software, or LiDAR derived hillshade and slope maps that can viewed in Google Earth.
- Oregon Lidar Consortium (<http://www.oregongeology.org/sub/projects/olc/>) – Small amount of Washington State data available along the Columbia River. LiDAR Data Viewer displays hillshade maps that have been filtered to remove vegetation and manmade structures.
- Puget Sound LiDAR Consortium (<http://pugetsoundlidar.ess.washington.edu/>) – Archive of LiDAR data from western Washington, downloadable as quarter quad tiles. Data format is ArcInfo interchange files and requires GIS software to view.
- Snohomish County Landscape Imaging: SnoScape (<http://gis.snoco.org/maps/snoscape/>) – Displays hillshade maps of bare or built topography derived from LiDAR data where it is available. Can be overlain with a wide range of additional maps relating to county infrastructure, property, hydrographic features, and planning.
- USGS EarthExplorer (<http://earthexplorer.usgs.gov/>) – Archive of downloadable LiDAR data acquired by the USGS through contracts, partnerships, and purchases from other agencies or private vendors. File format is LAS and requires GIS software for viewing.

---

<sup>109</sup> Roering et al., 2009; Handwerger et al. 2013; Scheingross et al. 2013.

<sup>110</sup> Mackey and Roering 2011.

<sup>111</sup> e.g., Ardizzone et al. 2007; Booth et al. 2009; Burns and Madin 2009; Tarolli et al. 2012; Van Den Eeckhaut et al. 2012.

<sup>112</sup> Travelletti and Malet 2012.



**APPENDIX F – TECHNICAL REPORTS AND RESOURCES**

In addition to library and online sources, the following technical reports, published and unpublished papers, and searchable databases are available online:

- Catalog of the Washington Geology Library. Searchable database of the Washington Department of Geology Library containing a comprehensive set of dissertations and theses, watershed analyses, environmental impact statements, and refereed and un-refereed publications on state geology. See DNR website with links to online publications where available.
- USGS Open File Reports. Searchable online database containing reports covering deep-seated landslide investigations and related topics. See USGS Online Publications Directory, USGS website.
- Watershed Analysis Mass Wasting Assessment reports per chapter 222-22 WAC. Adobe pdf versions of DNR-approved reports are available via the DNR website at <https://fortress.wa.gov/dnr/protectionsa/ApprovedWatershedAnalyses> (the URL may change without notice)
- U.S. Forest Service watershed analysis reports. Available from U.S. Forest Service offices for select watersheds; some electronic documents are available online through the U.S. Forest Service website for national forest of interest.
- Interagency watershed analysis reports. Collaborative projects between federal agencies (U.S. Geological Survey, U.S. Forest Service, U.S. Fish and Wildlife Service), tribal agencies, and industry (e.g., Cook and McCalla basins, Salmon River basin, Quinault watershed). Documents available online through the USGS, Washington Water Science Center.
- Washington Soil Atlas. Available as downloadable Adobe pdf file on the Natural Resources Conservation Service website.

## APPENDIX G – PHYSICAL DATABASES

Meteorological databases:

- National Weather Service (NWS) cooperative weather stations – coordinated by National Oceanic and Atmospheric Administration (NOAA) – database managed by Western Regional Climate Center
- NWS Weather Surveillance Radar – Doppler and NEXRAD
- Remote Automatic Weather Stations (RAWS) – operated by U.S. Forest Service and Bureau of Land Management – database managed by Western Regional Climate Center

Stream-flow gauge database: USGS National Water Information System website

Seismic data: Pacific Northwest Seismic Network – database managed by USGS, University of Washington, and Incorporated Research Institute for Seismology Consortium in Seattle. Contains records from seismometers located throughout Washington and Oregon.

Climate data for Washington: The availability of climate data is highly variable for the State of Washington. The following sites provide access to most of the available data useful for evapotranspiration modeling (the URLs may change without notice):

- USGS, Washington Water Data - <http://wa.water.usgs.gov/data/>
- National Surface Meteorological Networks - <https://www.eol.ucar.edu/projects/hydrometer/northwest/northwest.html>
- National Weather Service - <http://www.wrh.noaa.gov/sew/observations.php>
- National Climate Data Center - <http://www.ncdc.noaa.gov/>
- University of Washington Atmospheric Sciences - <http://www.atmos.washington.edu/data/>
- Washington State University - <http://weather.wsu.edu/awn.php>
- Community Collaborative Rain, Hail, and Snow Database - <http://www.cocorahs.org/>
- Western Regional Climate Summary for Washington - <http://www.wrcc.dri.edu/summary/climsmwa.html>
- Natural Resource Conservation Service - <http://www.nrcs.usda.gov/wps/portal/nrcs/main/wa/snow/>
- Washington Dept. of Ecology Water Resources - <http://www.ecy.wa.gov/programs/wr/wrhome.html>
- Washington Dept. of Transportation - [http://www.wsdot.com/traffic/weather/weatherstation\\_list.aspx](http://www.wsdot.com/traffic/weather/weatherstation_list.aspx)

National Resources Inventory for Washington State: Statistical survey of land use, natural resource conditions and trends in soil, water, and related resources on non-federal lands. Available on the NRCS website.

## APPENDIX H – HYDROLOGIC PROPERTIES OF SOILS

This adaptation from Koloski et al. (1989) relates geologic materials commonly found in Washington to the descriptive properties of permeability and storage capacity. A generalized explanation of the two terms is presented below, but is not intended to rigorously define either the geologic categories or the geotechnical properties. The information presented in the table is useful for indicating the general range of values for these properties. It should be considered representative, but is not a substitute for site-specific laboratory and field information.

Classification	Permeability (feet per minute)	Storage Capacity
Alluvial (High Energy)	0.01-10	0.1-0.3
Alluvial (Low Energy)	0.0001-0.1	0.05-0.2
Eolian (Loess)	0.001-0.01	0.05-0.1
Glacial Till	0-0.001	0-0.1
Glacial Outwash	0.01-10	0.01-0.3
Glaciolacustrine	0-0.1	0-0.1
Lacustrine (Inorganic)	0.0001-0.1	0.05-0.3
Lacustrine (Organic)	0.0001-1.0	0.05-0.8
Marine (High Energy)	0.001-1.0	0.1-0.3
Marine (Low Energy)	0.0001-0.1	0.05-0.3
Volcanic (Tephra)	0.0001-0.1	0.05-0.2
Volcanic (Lahar)	0.001-0.1	0.05-0.2

Permeability differences reflect variations in gradation between geologic materials. Very high permeability is associated with high-energy alluvial deposits or glacial outwash where coarse, open-work gravel is common. Permeability in these deposits can vary greatly over short horizontal and vertical distances. Extremely low permeability is associated with poorly to moderately sorted materials that are ice-consolidated and contain a substantial fraction of silt and clay.

Storage capacity reflects the volume of void space and the content of silt or clay within a soil deposit. Storage capacity is very low for poorly sorted or ice-consolidated, fine-grained materials such as till and glaciolacustrine deposits.

**Section 17**  
**Guidelines for the Small Forest**  
**Landowner Forestry Riparian Easement Program**

This section is under development.

# Section 18

## Rivers and Habitat Open Space Program

This manual contains guidance for acquisition of easements in the Rivers and Habitat Open Space Program (RHOSP). The guidance supplements Chapter 222-23 WAC, the rules that describe the program.

PART 1. OVERVIEW .....1

PART 2. POLICIES .....2

    2.1 Application Forms.....2

    2.2 Eligibility requirements.....2

    2.3 Acquisition timeline .....3

    2.4 Easement valuation process.....4

PART 3. PROPOSAL APPLICATION EVALUATION .....5

    3.1 How applications are selected for funding .....5

    3.2 Application criteria .....5

PART 4. GLOSSARY.....8

### PART 1. OVERVIEW

#### Introduction

The 2009 legislature passed Substitute Senate Bill 5401 which expanded the Riparian Open Space Program to include all unconfined CMZs as well as forest land that contains habitat of state-recognized threatened or endangered species. This program is now known as the Rivers and Habitat Open Space Program (RHOSP).

The program enables Washington State to contribute to the recovery of salmon and certain other riparian and aquatic species, and to the restoration of related riparian ecosystems and critical habitats as defined in WAC 222-16-080 of the forest practices rules. DNR implements this program, screens applications, prioritizes qualifying applications, and acquires easements based on available funding. DNR, through the program, acquires a permanent conservation easement on timber, or timber and land ensuring long-term conservation of aquatic and upland habitat. Once DNR acquires a permanent conservation easement from the landowner, timber harvest will not be allowed within the easement premises.

Grants, funds or gifts from any source, including private individuals will be allowed to perpetuate this program (RCW 76.09.260).

This manual provides guidelines to help the public understand how to apply for an easement and receive compensation for timber, or timber and land within unconfined CMZs and critical habitats of state-recognized threatened or endangered species that may not be able to be harvested due to the forest practices rules.

## **PART 2. POLICIES**

### **2.1 Application Forms**

Applicants for the program must fill out an application form provided by DNR. The application indicates the landowner's interest to grant a permanent easement and provides information about the scope of the proposal. DNR will use the information in the application to help determine proposal eligibility, as well as the priority for acquisition. Applications will be accepted in phases to facilitate a prioritization process in each application period. Those applications that do not receive funding initially can be resubmitted in subsequent application periods.

The application form and the instructions for completing an application will be made available at DNR Region offices, as well as in electronic format on DNR's webpage at <https://fortress.wa.gov/dnr/fpars/public/FPAForms.aspx>.

The application will include components of WAC 222-23-020(1), in addition to the following application elements:

1. Location and description of the land proposed for inclusion in the program, including estimated acreage, and whether the land is located within a qualifying CMZ or critical habitat.
2. Tax parcel identification number(s) of the parcel(s) that contain the qualifying CMZ or critical habitat lands.
3. List of all persons having any right or interest in the land covered by the application, a description of such right or interest, and the proper documentation. If the property is owned by a LLC, partnership, or other pass-thru entity, the applicant will provide a statement of authority that indicates adequate legal authorization to encumber the property with a permanent conservation easement.
4. A map showing where the qualifying CMZ land has been delineated on the ground following the guidance of Board Manual Section 2; or a map showing where the qualifying critical habitat has been delineated on the ground per WAC 222-16-080.
5. For critical habitat only, provide information on the type of critical habitat located on the land (e.g., Status 1 or 2 owl circle, occupied marbled murrelet habitat, etc.)
  - (a) Critical habitat information can be obtained from WDFW. WDFW provides maps and reports that answer the most common questions concerning the presence of important fish and wildlife species. To obtain a map including sensitive information, landowners may be required to sign a Sensitive Data Agreement. Contact WDFW's data request line at (360) 902-2543 for more information.
6. Information about the CMZ and/or critical habitat that will aid the DNR in prioritizing the application (see Section 3.2).

### **2.2 Eligibility Requirements**

Eligible land is classified as designated forest land (RCW 84.33), timber land or open space (RCW 84.34) and is owned by an individual, partnership, corporation or other nongovernmental entity.

### CMZ Eligibility

Use Board Manual Section 2 as a guide for delineating unconfined CMZs. Examples of unconfined CMZs include avulsing, meandering, and braided channels that generally are less than two percent in gradient.

### Critical Habitat Eligibility

Critical habitat for this program is state-recognized critical habitat as defined by the Forest Practices Board (Board) in WAC 222-16-080. The program will consider newly listed state-recognized habitats as they are included in the forest practices rules per the Washington Department of Fish and Wildlife's recommendations to the Board. DNR, after consultation with the WDFW, prepares and submits newly listed state-recognized threatened or endangered species to the Board for adoption in the forest practices rules per WAC 222-16-080(3).

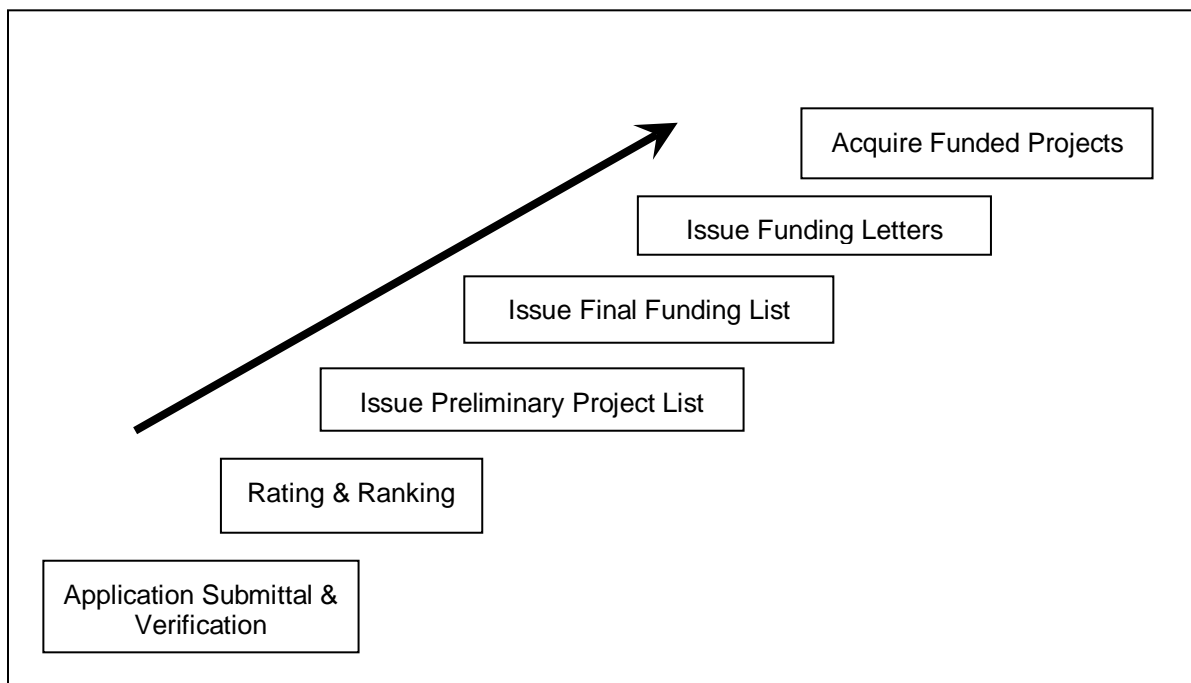
## **2.3 Acquisition Timeline**

### Funding Cycle process

Funding levels are subject to Washington State legislative appropriations. RHOSP conservation easement acquisitions are subject to appropriations from the State Legislature sufficient to cover the cost of the acquisition and the related costs of administering the program. Depending upon funding levels, the funding periods can be in annual or biennial funding cycles. Biennial funding cycles correspond with the state biennium and start every odd calendar year on July 1 (E.g. July 1, 2011, July 1, 2013, etc.) Applications to be considered for a funding cycle are those received prior to each funding period.

These acquisition funds may be divided into two funding categories:

1. Generally, when the funding level exceeds one million dollars, DNR expects to allocate approximately 70% for critical habitat and 30% for CMZs. If the demand is limited in either funding category, DNR may shift moneys between the funding categories.
2. The landowner may submit phased proposals so that easements can be acquired on portions of the timber, or timber and land. Depending upon the level of funding, the DNR may be limited in the proposal or easement acquisition size and partial funding would be allocated. For further assistance on phased proposals contact the Forest Practices Division (360) 902-1400 or [FPD@dnr.wa.gov](mailto:FPD@dnr.wa.gov).



**Figure 1: Funding Cycle Process Steps**

## 2.4 Easement valuation process

The compensation for these conservation easements are determined using the value of the timber found within the easement premises and in some circumstances may include a land value. There are two types of conservation easements the landowner may choose to grant and receive compensation for under this program: 1) a landowner may be compensated for a conservation easement that encumbers only the trees within the eligible area; or 2) a landowner may be compensated for a conservation easement that encumbers both the trees and the land within the eligible area. DNR will value the easement compensation using the Timber Value and the Land Value Components.

### Timber Value Component

The timber value component consists of two elements, 1) the cruise volume of all commercially valuable trees located within the proposed easement and 2) the stumpage values used to determine the forest excise tax of a timber harvest.

- Cruise Volume

DNR shall determine the cruise volume of the commercially valuable trees located within the proposed easement using a standardized cruise method. DNR and the landowner shall be in agreement on the sampling intensity and with the list of private timber cruise contractors selected for bidding on the timber cruise contract for the landowner's project.

- Timber Cruise

The timber cruise shall measure all commercially valuable trees within the lands to be conveyed and develop all information (species and grade) with respect to that timber necessary to apply the stumpage tables developed by the Department of Revenue (DOR) pursuant to RCW 84.33.091; this includes volume by species and grade sufficient to



apply the DOR stumpage tables in WAC 458-40-640, 458-40-650, 458-40-660(2), and 458-40-660(3).

- **Stumpage Value**

A stumpage value is determined by using Department of Revenue's (DOR) Forest Excise Tax procedure for the harvest of timber. All elements of the DOR procedures (e.g., stumpage value area, timber quality codes, and harvest value adjustment) are used to determine the final stumpage value.

**Land Value Component**

DNR will use a combination of the Timber Value Component and the Land Value Component to determine the value for those easements that the landowner chooses to convey an easement on both the timber and land. The land value component consists of two elements: 1) the size of the proposed easement in acres, and 2) the per-acre land value of commercial timber land. DNR will determine the acreage of the easement using the current standard used by DNR's land management program for determining timber harvest acres for timber appraisals. The per-acre land value is an average value to be determined, with consultation from the DOR, every calendar year with separate values for western Washington and eastern Washington. The definition of the geographic area of the proposed easement premises expressed by eastern and western Washington will be the same as that used by DOR.

## **PART 3. PROPOSAL APPLICATION EVALUATION**

### **3.1 How applications are selected for funding**

**Prioritization**

DNR will assemble a ranking committee in order to prioritize applications within a funding cycle. DNR will consult with other agencies to provide members, with appropriate expertise, to serve on the prioritization ranking committee (committee) for each application period to provide technical expertise. Application materials will be provided to the committee and selection of the highest ranking proposals will occur.

In an effort to maximize the use of all available funds, DNR will use a statewide prioritized list of RHOSP proposals. The proposals will be evaluated based on the rating criteria established in section 3.2 and recommendations from the committee. DNR expects to allocate approximately 70% of the funds for critical habitat and 30% for CMZs. A statewide priority list of CMZ and critical habitat proposals will be created by evaluating these proposals based on the rating criteria established in 3.2 and recommendations from a prioritization ranking committee.

### **3.2 Application criteria**

The committee will use the Unconfined CMZs & Critical Habitat Evaluation Summary in Attachment A to establish prioritization of proposals. The committee will also use the landowner application information in their prioritization process, including:

1. **Ecological/Biological Characteristics.** Why is the proposed site worthy of a permanent conservation easement?

Describe your proposal as accurately as possible to the committee - the what, where, and why. The committee will draw conclusions based on the information presented about the quality and potential function of the habitat and the demonstrated need to protect it for fish and/or wildlife. You may submit up to two maps and/or pictures of your proposed easement site.

**SCOPE and PLANNING.** Is this proposal supported by a current plan (i.e., local watershed, statewide, agency, or conservation species management recovery plans, State or Federal recovery plans, Safe Harbor Agreement(s), habitat conservation plans), or a coordinated region-wide prioritization effort? What is the status of the plan? What process was used to identify this project as a priority? What specific role does this project play in a broader watershed or landscape picture? Is it part of a phased project? Is it a stand-alone site/habitat?

**SIGNIFICANCE.** Explain how the proposed site is significant on a state, ecosystem, and/or watershed level. How significant is the site in relation to habitat quantity, quality, connectivity, diversity, and rarity? How is the site important in providing habitat for fish and/or wildlife species?

**FISH AND WILDLIFE SPECIES AND/OR COMMUNITIES.** Is the critical habitat or CMZ connected to or adjacent to other habitat areas, conservation easements (forest riparian, land trust, etc.) or plans per WAC 222-16-080(6)? What species (salmonids, northern spotted owls, marbled murrelets, etc.) are currently using your site? Which species have the potential and likelihood to use the site in the future? Are there other species of interest located on this site?

**HABITAT QUALITY.** Describe the ecological and biological quality of the habitat.

**CRITICAL HABITAT.**

Which species with critical habitat needs (northern spotted owls, marbled murrelets, salmonids, bull trout, eagles, etc.) does your proposed area support? How is this habitat important for providing food, water, cover, connection to other forested areas, nesting, breeding, and resting areas? Could your site provide a wildlife habitat corridor or partial corridor? For aquatic habitat, describe the amount and size of large woody debris (LWD) found on site. Describe the presence and diversity of habitat that fish, of all life stages, can occupy (e.g., pools, undercut banks, riffles, overhead cover, side channels, etc.). Have there been any disturbances (e.g., man-made or natural such as logging, road building, bridge placement, rip-rap placement, fires, landslides, debris flows, etc.)?

**CMZs.**

Do you have LWD in your stream/river? Do you have large trees next to the stream/river for LWD recruitment, shade, etc. (list tree size and estimate of number)? Do you have a forested island within the stream/river channel? Does your CMZ show active movement over the recent past, or potential for future movement? Are there secondary or side channel habitats, oxbows, etc.? Please refer to Board Manual Section 2 to aid in the description of the CMZ on your proposal.

**FOREST TYPE.** Does the stand consist of conifer, hardwood trees, or a mix (list % of each)? What is the average age of the trees, or stand origin date? Describe how many large [> 28 inch diameter] trees are on your site and their diameters at breast height (DBH). Do you have a multistory stand – two or more distinct age classes of trees? List multiple tree species your proposed easement may contain such as Douglas-fir, western red cedar, western hemlock, Sitka spruce, red alder, Black cottonwood, big leaf maple, etc. Are there snags within the proposed area (list number  $\geq$  10 inches DBH and species)? See WAC 222-16-080 for specific characteristics for critical habitat that is on your land and describe how your proposed area meets that criterion.

**WATER QUALITY.** *Please provide this information for a CMZ application only.*

How will your proposal assist in maintaining or restoring water quality? Is the stream/river on the Department of Ecology's 303(d) list; is the water quality impaired (temperature or sediment too high)? Does your CMZ contain mature timber? Does the habitat associated with the CMZ provide protection for fish (e.g., side channels for high flows or over-wintering habitat)? The following link will help provide information on 303(d) water quality <http://apps.ecy.wa.gov/wqawa2008/viewer.htm>.

**2. Manageability and Viability. What is the likelihood of the site remaining viable over the long-term and why is it important to conserve it now?**

The intent of this question is to determine how the proposed site will be managed to protect the target species or communities.

**LONG-TERM VIABILITY OF THE SITE TO PROVIDE HABITAT.** What is happening across the landscape or watershed that may affect the viability of the proposed site to support critical habitat needs? Is this site located on a river that is subject to seasonal flooding and river course changes? Describe any long-term site monitoring plans on the site and identify who will implement monitoring. Are there opportunities to enhance habitat and/or water quality, if so, please describe?

**PROXIMITY AND CONNECTIVITY TO EXISTING PROTECTED LAND.** Are there other protected lands (public and private) near or adjoining this site that have complementary or compatible land uses for the target species (consider wide-ranging or migratory species)? Is the land located adjacent to an existing conservation easement (forest riparian, land trust, etc.) or an unstable slope? Are they managed in a manner consistent with the needs of the target species/communities? Is this site part of a larger ownership? If so, describe the connectivity and management of the other land.

**ON-GOING STEWARDSHIP OF FOREST.** Describe any planned or on-going stewardship activities (e.g., restoration activities, large woody debris placement, fish habitat enhancement, noxious weed control, forest health, fire hazard reduction etc.) and identify the source of funds. What is the current or future use for this site (e.g., cabin, recreation, hunting, hiking, etc.)?

**EXTERNAL FUNDING SUPPORT.** If your project is a component of a larger project, describe and document other monetary means that have been or may be secured to help cover the costs for the project (i.e., grants, donations, in-kind contributions, matching funds, etc.).

#### **PART 4. GLOSSARY**

**Channel migration zone (CMZ):** The area where the active channel of a stream is prone to move and this results in a potential near-term loss of riparian function and associated habitat adjacent to the stream, except as modified by a permanent levee or dike. For this purpose, near-term means the time scale required to grow a mature forest. (See board manual section 2 for descriptions and illustrations of CMZs and delineation guidelines.)

**Critical habitat (state):** Those habitats designated by the board in accordance with WAC 222-16-080.

**Diameter at breast height (dbh):** The diameter of a tree at 4 1/2 feet above the ground measured from the uphill side.

**Habitat corridor:** area of habitat connecting wildlife populations separated by human activities (such as roads, development, or logging).

**Threatened or endangered species:** All species of wildlife listed as "threatened" or "endangered" by the United States Secretary of the Interior or Commerce, and all species of wildlife designated as "threatened" or "endangered" by the Washington fish and wildlife commission.

**Overflow channel:** A secondary channel on the floodplain that conveys water away from and/or back into the main channel. These channels can be continuous or interrupted in space in terms of channel dimensions and scour and fill. They often are a response to episodic flood scour and fill during floodplain inundation and drainage. They also can partially fill in between episodic flood events or become abandoned completely or be blocked by deposits of sediment or wood at their head. Overflow channels are typically at or above the range of bankfull flow elevations.

**Oxbow lake:** A crescent shaped pond or lake formed in a portion of abandoned stream channel cut off from the rest of the main channel created when meanders are cut off by avulsions from the rest of the channel. Once isolated by formation of avulsion channels, oxbow lakes will slowly fill up with sediment, as point bar sands and gravels are buried by silts, clays, and organic material carried in by river floods and by sediment slumping in from sides as rain fills up lake.

**Secondary channel:** Any channel on or in a floodplain that carries water (intermittently or perennially in time; continuously or interrupted in space) away from, away from and back into, or along the main channel. Secondary channels include: side channels, wall-based channels, distributary channels, anabranch channels, abandoned channels, overflow channels, chutes, and swales.

**Side channel:** A secondary or anabranch channel that is at least partially connected to the main river channel with its channel thalweg at or below the range of bankfull flow elevations. Side channel inlets are often blocked by wood jams or large accumulations of gravel and sand.

**Snag:** A standing dead tree may have some live limbs toward the top of the tree.

**Attachment A  
DNR Rivers and Habitat Open Space Program**

<b>Unconfined CMZs &amp; Critical Habitat Evaluation Summary</b>		
<b>Criteria</b>	<b>Evaluation Elements</b>	<b>Possible Points</b>
Proposal Introduction	<ul style="list-style-type: none"> <li>• Location of the proposal on statewide, vicinity, and site maps</li> <li>• Brief summary of the proposal [goal(s) and objective(s) statement]</li> <li>• Proposal Support</li> </ul>	Not scored
Ecological and Biological Characteristics	<ul style="list-style-type: none"> <li>• Scope and Planning/significance of the proposed site</li> <li>• Benefits to fish and wildlife species and/or ecological communities</li> <li>• Habitat Quality</li> <li>• Forest Type</li> <li>• Water quality (for CMZ applications only)</li> </ul>	30
Manageability and Viability	<ul style="list-style-type: none"> <li>• Long-term viability of the proposed site to provide habitat</li> <li>• Proximity and connectivity to existing protected land</li> <li>• On-going stewardship of the forest</li> <li>• External funding support</li> </ul>	20
<b>Total Points Possible</b>		<b>50</b>

## **Section 19**

# **Guidelines for Hardwood Conversion**

This section is under development.

## **Section 20**

# **Guidelines for Financial Assurances**

This section is under development.



## Section 21

### Guidelines for Alternate Plans

This section provides guidelines for developing and analyzing alternate plans for activities that vary from specific forest practices rules. Alternate plans may be useful in a variety of situations. Examples could be:

- Where the cumulative impact of rules disproportionately affects a landowner's income production capability.
- Where a landowner's minor on-the-ground modifications could result in significant operational efficiencies.
- Where site conditions have created an economically inaccessible management unit when using the forest practices rules.
- Where local landforms lend themselves to alternate forest management practices.
- Where a landowner proposes methods to facilitate landscape, riparian or stream restoration.

In alternate plans, landowners develop management prescriptions that will achieve resource protection through alternative methods from those prescribed in the forest practices rules. Any rule prescription not changed as part of an alternate plan must be followed as outlined by rule. To be approved alternate plans must provide protection for public resources at least equal in overall effectiveness to the protection provided by the Forest Practices Act and rules. Alternate plans are an option for all landowners.

This Board manual section contains two parts. Part 1 provides a general discussion of alternate plan requirements and riparian function and pertains to all landowners. Part 2 provides information on alternate plan templates for small forest landowners and contains Template 1- Small Forest Landowner Western Washington Thinning Strategies for Overstocked Conifer-Dominated Riparian Management Zones. Additional technical assistance and scientific information to support proposed management prescriptions is available on the DNR Small Forest Landowner Office website at <http://www.dnr.wa.gov/sflo/>.

PART 1. ALTERNATE PLANS .....	1
1.1 Riparian Function Considerations.....	2
<i>Figure 1. Riparian function.</i> .....	2
<i>Figure 2. Cumulative effectiveness of various riparian functions.</i> .....	4
1.2 Alternate Plan Evaluation for Riparian Areas .....	8
PART 2. ALTERNATE PLAN TEMPLATES FOR SMALL FOREST LANDOWNERS .....	8
Template 1. Small Forest Landowner Western Washington Thinning Strategies for Overstocked Conifer-Dominated Riparian Management Zones.....	9
Template 2. Fixed Width Riparian Buffers for Small Forest Landowner's in Western Washington .....	15

#### **PART 1. ALTERNATE PLANS**

The alternate plan policy is described in WAC 222-12-040. The requirement for the application process, plan preparation responsibilities, required contents and plan review procedures are

described in WAC 222-12-0401. Key elements of alternate plans include a map showing locations of:

- Any affected streams and other waters, wetlands, unstable slopes, and existing roads.
- Proposed management activities.

Alternate plans also should include:

- Descriptions of the current conditions of the site, including upland and riparian conditions. For help in assessing riparian conditions see 1.1 Riparian Function Considerations.
- Descriptions of the proposed management activity, including all resource protection or enhancement activities. Make sure the scale of management descriptions fit the scope of the project. For example, the removal of a few specific riparian trees may require different protection or enhancement measures than a riparian thinning of an entire stream segment.
- A list of the forest practices rules that the alternate plan is intended to replace.
- Where applicable, a monitoring and adaptive management plan.
- Where applicable, an implementation schedule.

### 1.1 Riparian Function Considerations

Understanding riparian areas and riparian functions is important to building an alternate plan. Riparian areas are transitional zones between the aquatic and upland environments. (In contrast, Riparian Management Zones in the forest practices rules are minimum stream buffers.) Riparian areas contribute to overall stream health by maintaining essential riparian functions and productivity.

The forest practices rules for riparian areas are designed to protect aquatic resources and related habitat to achieve restoration of riparian function. Under the rules, “riparian function” includes bank stability, the recruitment of woody debris, leaf litter fall, nutrients, sediment filtering, shade, and other riparian features that are important to both riparian forest and aquatic system conditions.

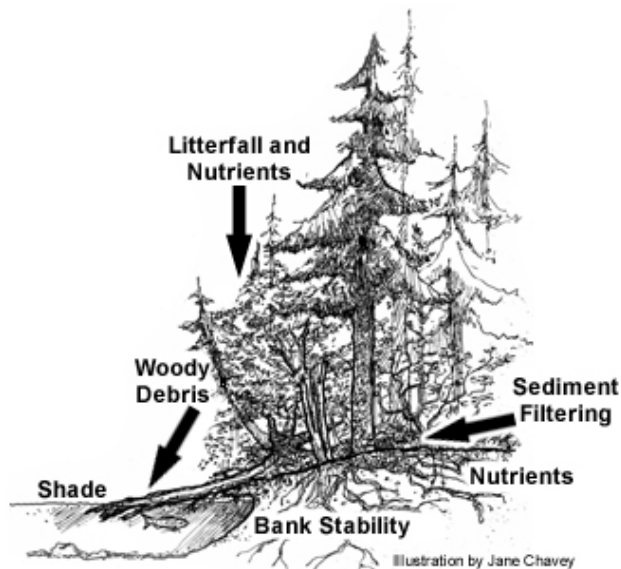


Figure 1. Riparian function.

The goal of this guidance is to help landowners identify, restore and maintain riparian function. This guidance focuses on:

- Stream shading
- Stream bank stability
- Woody debris availability and recruitment
- Sediment filtering
- Nutrients and leaf litter fall

Landowners should understand how riparian areas contribute to overall stream health in order to incorporate riparian functions maintenance and/or enhancement measures into their alternate plans. Considering site-specific conditions of the riparian area allows reviewers and landowners to make informed decisions about proposed management activities. Riparian areas are dynamic and the current condition of riparian functions will vary among individual stream segments and throughout the watershed.

As planning begins, landowners should consider:

- The makeup of the tree species within the riparian area, and the level to which the forest is currently providing the riparian functions to the stream.
- The potential level of the riparian functions that the forest could contribute to the stream.
- The potential level of functions that would be lost without management intervention.
- How the riparian areas could be managed to achieve sufficient levels of riparian function, and how to maintain these levels when achieved.

#### Areas of Influence

Before developing alternate plan prescriptions, the landowner or forester should identify the areas of influence for each riparian function. In this manual, the “area of influence” is the area that may affect a particular riparian function. Site specific conditions determine the size of the area of influence for each riparian function.

The figure below shows the general relationship between cumulative effectiveness of various riparian functions and a distance from the stream channel. Distance from channel is expressed as a proportion of tree height. (Bank stability is shown as root strength in this figure.) The descriptions under *Assessing Riparian Functions*, in the following pages, will help determine the appropriate widths of the areas of influence for each riparian function.

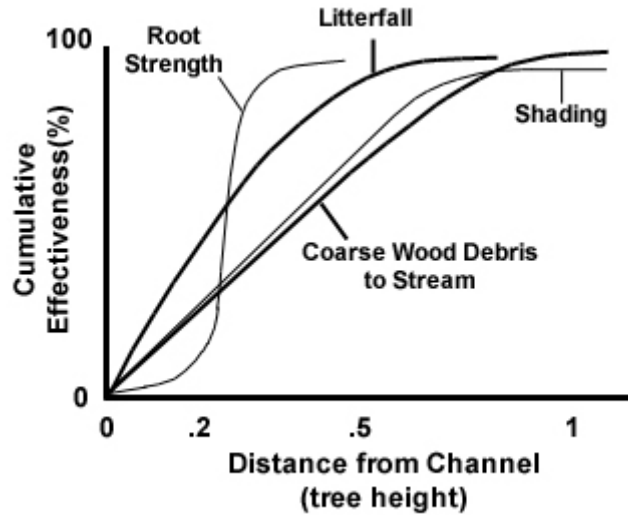


Figure 2. Cumulative effectiveness of various riparian functions. From Forest Ecosystem Management Assessment Team (FEMAT), (1993). *Forest ecosystem management: an ecological, economic, and social assessment*. Washington DC: US Government Printing Office 1993-793-071.

### Assessing Riparian Functions

The following descriptions of riparian functions are intended to help landowners and foresters determine current riparian conditions and how management strategies can result in properly functioning riparian areas.

#### Stream Shading

The most significant influence on stream temperature, under the control of forest managers, is shade from the canopy of the adjacent riparian area vegetation. An important function of canopy cover in the riparian area is to provide shade to maintain cool stream temperatures. This is a particularly vital function for fish and amphibians.

To determine the area of influence of the shade function, consider the guidance provided in Board Manual Section 1, *Method for Determination of Adequate Shade Requirements on Streams*. Following the steps of this manual can help the landowner to establish the minimum width of the riparian area needed to meet the water quality standards for stream temperature. For streams within channel migration zones, additional guidance may be obtained from Board Manual Section 2, *Standard Methods for Identifying Bankfull Channel Features and Channel Migration Zones*. The trees closest to the stream are the most important for shade. The area of influence of shade from trees usually extends for a distance of 75 feet measured from the outer edge of bankfull width (BFW) or the edge of the channel migration zone (CMZ).

#### *When evaluating areas of influence for shade:*

To understand the overall impact of management activities on the shade function, consider all of the forest characteristics in the riparian areas within the stream reach to be included in the alternate plan. The level of influence the overstory riparian canopy has on water temperature depends on a variety of factors, including:

- Stream size. Streams less than 30 feet wide are greatly influenced by riparian shading in the summer months. In larger streams, the influence of shade on water temperature will be site-specific.
- Topography. Local topography, such as steep hill slopes or cliffs may provide shading to the stream.
- Channel orientation. On east-west oriented channel segments, the shade from riparian vegetation on the south side of the stream has a greater and more direct influence on the stream than vegetation on the north side of the stream.
- Understory vegetation. Thick understory vegetation can contribute to stream shading, especially in entrenched or narrow stream channels.
- Canopy openings. Canopy openings naturally occur from bank erosion, vegetation succession, or stream bank disturbances such as flooding, debris flow, fire, or wind.

The best strategy for providing shade to protect stream temperature is to retain or develop a multi-storied riparian forest that is wide enough to minimize the impacts of solar radiation on the stream environment.

#### Stream Bank Stability

Maintaining stable stream banks will allow channel structure to develop naturally. Natural erosion of stream banks enhances channel function by:

- Recruiting sand, gravel, and other stream bank material needed for various in-stream habitats.
- Exposing tree root-wads on the stream bank that can provide cover for fish and eventually recruit large wood to the channel.

Maintaining stream bank vegetation is vital to maintaining stable stream banks. The roots of vegetation hold soil together, slow water velocities and facilitate deposition of sediments during high stream-flow events. Loss of stream bank vegetation can accelerate stream bank erosion which can destroy fish spawning and rearing habitats.

The area influencing stream bank stability usually extends a distance equal to  $\frac{1}{2}$  the average crown diameter of the dominant conifer trees closest to the outer edge of BFW or the CMZ, or to the top of the first terrace from the outer edge of BFW or the CMZ. However, streams showing evidence of channel movement may require protecting more area to accommodate future channel migration. A good reference for determining potential channel movement is Board Manual Section 2.

#### **Determining Crown Diameter**

To determine  $\frac{1}{2}$  the average crown diameter, measure the crown diameters of at least 10 dominant conifer trees within 30 feet of the edge of BFW or CMZ, and divide the average of those 10 diameters by 2.

*When evaluating the areas of influence for stream bank stability:*

- Look for connected root masses along the management area.

- Look for deeply undercut banks which indicate the channel is migrating.
- Anticipate which streamside trees could fall from root rot, stream undercutting, heavy lean, or susceptibility to windthrow; then consider which adjacent trees should be retained to maintain long-term bank stability.

The best strategy is to maintain live trees and vegetation within the area of influence to provide the greatest stability to stream banks.

#### Woody Debris Availability and Recruitment

Ecological functions associated with large woody debris (LWD) are an important part of productive in-stream habitat. LWD provides important habitat diversity by providing structure for stabilizing streambeds, building floodplains, storing sediment, retaining spawning gravels, maintaining flow complexity, storing nutrients, and providing habitat for fish and/or stream-associated amphibians. LWD should be of a size (length and width) and species to remain intact and stable for many years. See Board Manual Section 26 *Guidelines for Large Woody Debris Placement Strategies*, under “The criteria for wood placement” for more information.

Wood naturally enters streams from:

- Fallen dead trees.
- Trees undercut by stream flows.
- Disturbance events such as debris torrents, landslides, fire, insects, disease, and wind storms.

LWD from large trees forms pools and cascades in streams. However, many riparian areas no longer have large diameter trees available to fall into the streams. Small diameter wood may be available but is not necessarily adequate to provide optimum riparian woody debris function. Therefore, both short-term and long-term woody debris recruitment is desirable. Woody debris comes from the riparian forest adjacent to the stream and by water transport from areas upstream.

Any tree that has the potential to contribute wood to the stream is within the LWD area of influence. Trees closest to the stream have the highest potential to fall into the stream. To determine the width of the area influencing woody debris input and availability consider the potential tree height of the tallest (dominant) trees on the site. The area of influence for LWD recruitment may be estimated as the distance equal to 75 percent of the 100-year site-potential tree height of the dominant trees within the riparian area, measured from the outer edge of BFW or CMZ.

*When evaluating the areas of influence for woody debris recruitment consider:*

- Trees leaning towards the stream. The most likely candidate trees for entering a stream are those leaning towards the stream, and trees located on steep slopes, on the edge of the first terrace, and in inner gorges.
- Hardwood contribution for short-term benefit. Woody debris from hardwood forests decomposes faster than woody debris from conifer forests.
- Placing large wood to enhance the near-term function. This will allow the development of long-term woody debris recruitment opportunities within the riparian forest. For technical guidance on in-channel woody debris placement, see Board Manual Section 26.

- The extent and conditions of existing in-stream woody debris adjacent to the proposed area of harvest.
- The productivity of the soil. Higher soil productivity will grow taller trees for future supply of woody debris to the stream. More productive soils will have larger areas of influence.
- Promoting growth of existing understory conifer by releasing it from competing brush and hardwood vegetation. This may be preferable to relying on seedling growth.
- Extending the area of influence where there is the potential for channel migration. For guidance on the potential for channel migration, see Board Manual Section 2.

The best strategy for woody debris availability is to manage for the potential recruitment of LWD for the short- and long-term.

### Sediment Filtering

Riparian vegetation helps to filter sediments, reduce the likelihood of landslide events, and regulate the natural erosion processes within riparian areas. Reducing the amount of fine sediment entering streams and other water bodies is a major function of the riparian area. Riparian vegetation can prevent sediment from entering the stream as a result of ground disturbance or skid trails in upland areas, and roads or road cross drains.

The width of the riparian area and the amount of riparian vegetation needed to perform filtering varies according to stream size and channel type. Large streams that connect to a floodplain at high flows require greater distances for sediment filtering than small, incised channels that rarely experience overbank flows.

Areas influencing sediment filtering are usually within 30 feet of the outer edge of BFW or CMZ, or to the top of the first terrace beyond the outer edge of BFW or CMZ. This area of influence may extend to the top of the second terrace if the first terrace is susceptible to frequent flood emersion or stream erosion.

*When evaluating the areas of influence for sediment filtering consider that:*

- Management activities on exposed soils in riparian areas have the potential to deliver to streams.
- Management activities on steeper ground have higher potential for sediment delivery to streams.

The best strategy to prevent sedimentation caused by management activities is to keep equipment from operating below the topographic break directly above a stream or within 30 feet of the stream.

### Nutrients and Leaf Litter Fall

Riparian areas play a key role in determining the concentration of nutrients in stream water. Uptake and storage of various elements carried by overland flows and groundwater are influenced by both the width of riparian buffers and the species of vegetation present.

Organic input from riparian vegetation influences water quality and provides an important food source for aquatic organisms. The size, composition, and age of the riparian forest will determine the amount of organic material available to be deposited into the stream.

The area influencing nutrient input from litter fall is the maximum distance that leaf litter could be expected to reach the stream. This distance depends on tree species composition, understory riparian vegetation, height of the canopy, topographic features and prevailing winds.

*When evaluating the areas of influence from nutrients and litter fall consider:*

- The tree species composition of the riparian stands.
- The understory species composition of the riparian stands.
- Maintaining a portion of bank along the streams in hardwood forests.
- The long-term advantages of converting to conifer.

The best management strategy for nutrients and leaf litter fall is to ensure diverse vegetation composition within the area of influence.

## **1.2 Alternate Plan Evaluation for Riparian Areas**

Because of the complexity of riparian areas, any given riparian area may not provide the ideal characteristics for each function. To be approved, alternate plans must be designed to provide for riparian function at least equal in overall effectiveness to the protection provided by the Forest Practices Act and rules.

*When evaluating alternate plans consider:*

- The goal of the riparian rules which is to protect aquatic resources and related habitat to achieve restoration of riparian function, and to maintain these resources once they are restored. The rules provide for the conversion and/or treatment of riparian forests which may be understocked, overstocked or uncharacteristically hardwood-dominated while maintaining minimum acceptable levels of riparian function.
- The extent to which each riparian function is currently found in the riparian area.
- Which site conditions (for example, topography, channel structure, elevation, site class, and soil type) may impact the risks from proposed management activities.
- Whether the overall benefit to the aquatic environment after proposed management activities would provide a greater long-term benefit in function than the potential short-term decrease in function.

## **PART 2. ALTERNATE PLAN TEMPLATES FOR SMALL FOREST LANDOWNERS**

The Forest Practices Act and rules require developing simple, easy to apply small forest landowner options for alternate plans or alternate harvest restrictions on smaller harvest units that may have a relatively low impact on aquatic resources. These alternate plans are intended to provide flexibility to small forest landowners that will still provide protection of riparian functions based on specific field conditions or stream conditions on the landowner's property.

Small forest landowners as defined in WAC 222-21-010(13) and RCW 76.13.120(2)(c), are landowners who have harvested from their own lands in the state of Washington less than 2 million board feet per year for the three years prior to the year of application, and certify at the



time of application that they do not expect to harvest more than 2 million board feet per year during the ten years following application.

### **Template 1. Small Forest Landowner Western Washington Thinning Strategies for Overstocked Conifer-Dominated Riparian Management Zones**

#### **Background**

With the 2001 Forest Practices rules, riparian management zones (RMZ) on forested streams became wider and required more leave trees than previously required under the forest practices rules. Reforestation from previous forest management activities, and in some cases natural stocking levels, has resulted in high tree densities of conifer species within riparian areas. These managed stands were densely planted with the intent to commercially thin, to promote growth of superior trees and to generate income to the small forest landowner. Without thinning, the canopies of these stands will begin to close, causing the trees to compete for resources, slowing the overall growth of the plantation, and increasing tree mortality.

#### **Purpose**

The purpose of this overstocked stand template is to increase riparian function on stands that have or will show signs of suppressed growth, and to increase the economic viability of the small forest landowner in these situations. Through commercial thinning, these stands can be managed in a manner that will establish understory vegetation and achieve larger tree diameters of the residual stands faster than would have occurred under a no thinning option.

This template provides flexibility for small forest landowners to harvest while protecting riparian functions. The harvest strategies for this template includes a no harvest zone and a thinning zone that meets or exceeds the stand requirements to achieve the goal in WAC 222-30-010(2): ". . . to protect aquatic resources and related habitat to achieve restoration of riparian function; and the maintenance of these resources once they are restored."

#### **Process**

Adherence to all of the strategies within this template will meet the riparian function requirements for the approval of an alternate plan as described in WAC 222-12-0401(6): "An alternate plan must provide protection for public resources at least equal in overall effectiveness to the protection provided in the act and rules." An alternate plan must include the template form, available through the DNR. The form must be included with the forest practices application. This form provides the technical justification as required in WAC 222-12-0401(3)(b), (c), and (d), identifying how the alternate plan addresses the various functional requirements of the RMZ.

#### **Qualifying Stands**

Qualifying stands are stands with at least 70% conifer with a canopy that is closing, having a minimum of 300 trees per acre (TPA) at the time of stand initiation and located within an RMZ adjacent to Type S, F or Np waters. Landowners planning to thin a qualifying stand within an RMZ protected by the Shoreline Management Act (RCW 76.09.910) must consult with the county of jurisdiction and include written documentation from the county stating that the operation complies with the Shoreline Management Act. This documentation must be included with the forest practices application.

**Riparian Management Zones**

This template differs from standard rules by:

- Allowing thinning of conifer within RMZs for Type S, F, and Np Waters; and
- Requiring an RMZ for the entire length of the Type Np Water length, not just 50% of the length.

The total RMZ widths of Type S, F, and Np Waters are the same as in standard rules. The template separates the RMZ into three management zones (no harvest, thinning, and outer) for Type S and F Waters, and two management zones (no harvest and thinning) for Type Np Waters.

RMZ widths are measured horizontally from the outer edge of bankfull width (BFW) or the channel migration zone (CMZ) on Type S and F Waters or the outer edge of BFW on Type Np Waters (see Board Manual Section 2).

**Harvest Prescriptions**

*Type S and F Water Thinning Strategy*

*No Harvest Zone:* The width of the no harvest zone is measured horizontally from the outer edge of BFW or the CMZ and is determined according to the following criteria:

- A distance equal to 1/2 the average crown diameter of the dominant conifer trees closest to the edge of the BFW or CMZ. To determine this distance, measure the crown diameters of at least 10 dominant conifer trees within 30 feet of BFW.
- The no harvest zone must include all conifer trees within the first row nearest the outer edge of BFW or the CMZ.
- The no harvest zone must be between 14 and 30 feet from BFW or CMZ.
- Measured trees cannot be harvested to allow for compliance and monitoring. Each tree must be marked and numbered.

*Thinning Zone:* The thinning zone is measured from the outer edge of the no harvest zone. The combined distance of the no harvest and thinning zone, as measured from the outer edge of BFW or CMZ, can be no less than 75 feet. To determine the total widths of the no harvest and thinning zone use the following table.

<i>Site Class</i>	<b>Combined Widths of No Harvest and Thinning Zones</b> (Measured from the outer edge of bankfull width or channel migration zone)	
	Stream BFW width ≤ 10 feet	Stream BFW width > 10 feet
<b>I</b>	133 feet	150 feet
<b>II</b>	113 feet	128 feet
<b>III</b>	93 feet	105 feet
<b>IV</b>	75 feet	83 feet
<b>V</b>	75 feet	75 feet

The harvesting strategies for the thinning zone are:

- Maintain a minimum of 100 conifer trees per acre post harvest with a maximum harvest of 65% of the trees cut in any one entry. The shade requirements must be met within 75 feet of the stream, as described in WAC 222-30-040 and Board Manual Section 1;

- Thin from below, where at the end of harvest the average stand diameter will be the same or larger than the average stand diameter before harvest. The guideline for this is  $d/D < 1$ .
- Follow the Large Woody Debris Placement Strategy (see below) when the thinning results in a stand less than 180 trees per acre.
- Thinning must not result in a stand with fewer than 100 well-distributed conifer trees per acre.
- Maintain an equipment limitation zone (ELZ) of 30 feet, as measured from the outer edge of BFW or CMZ.
- Soil disturbance within the ELZ cannot result in sediment delivery to the stream.
- Suspend one end of the log during yarding within the ELZ. Use directional falling away from the stream to minimize stream bank disturbance. In the thinning zone, use ground-based yarding systems only on slopes less than 35%.
- On slopes greater than 35% fully suspend all trees yarded through the thinning zone.

*Outer Zone:* Harvest according to the outer zone rule outlined in WAC 222-30-021(1)(c).

#### Type Np Waters Thinning Strategy

One of two harvesting practices can be applied along Type Np Waters, but not both in any one harvest entry. The standard RMZ buffer as outlined in WAC 222-30-021(2) may be applied or the thinning strategy as described may be applied.

Establish a 50-foot RMZ for the total length of the Type Np Water. Within this RMZ, establish a no harvest zone and thinning zone.

*No Harvest Zone:* Measure the width of the no harvest zone horizontally from the outer edge of bankfull width according to the following criteria:

- A distance equal to  $1/2$  the average crown diameter of the dominant conifer trees closest to the edge of BFW. To determine this distance, measure the crown diameters of a minimum of 10 dominant conifer trees within 30 feet of BFW.
- The no harvest zone must include all conifer trees within the first row nearest the outer edge of BFW.
- The no harvest zone must be between 14 feet and 30 feet in width.
- No allowable harvesting of measured trees. Each tree must be marked and numbered.

Harvesting must not occur within any sensitive site buffers. Sensitive sites include the 56-foot radius buffer patch centered on the point of intersection of two or more Type Np Waters, headwall seeps, sidewall seeps, headwater springs or the points at the upper most extent of Type Np Waters, or within an alluvial fan. See WAC 222-30-021(2)(b)(i) through (vi).

To determine  $d/D < 1$ , first calculate the quadratic mean diameter of the trees to be cut ( $d$ ), next calculate the quadratic mean diameter of the stand prior to thinning ( $D$ ), then compare the ratio of  $d/D$  to assure the value is less than one.

*Thinning Zone:* The harvesting strategies for the thinning zone are:

- Maintain a minimum of 100 conifer trees per acre with a maximum harvest of 65% of the trees cut in any one entry.
- Thin from below, where at the end of harvest the average stand diameter will be the same or larger than the average stand diameter before harvest. The guideline for this is  $d/D < 1$ .

To determine  $d/D < 1$ , first calculate the quadratic mean diameter of the trees to be cut ( $d$ ), next calculate the quadratic mean diameter of the stand prior to thinning ( $D$ ), then compare the ratio of  $d/D$  to assure the value is less than one.

- Follow the Large Woody Debris Placement Strategy (see below) when the thinning results in a stand less than 180 trees per acre.
- Maintain at least 100 well-distributed conifer trees per acre after thinning.
- Maintain an ELZ of 30 feet, as measured from the outer edge of BFW during all harvest activities.
- Soil disturbance within the ELZ must not result in sediment delivery to the stream.
- Suspend one end of the log during yarding within the ELZ. Use directional falling away from the stream to minimize stream bank disturbance. In the thinning zone, use ground-based yarding systems only on slopes less than 35%.
- All trees yarded through the thinning zone using cable thinning on slopes greater than 35% must be fully suspended.

### **Large Woody Debris Placement Strategy**

A forest practices hydraulic project (FPH) is required for large woody debris placement in Type S or F waters. See Board Manual Section 5, *Guidelines for Forest Practices Hydraulic Projects* for information regarding woody debris placement.

Ecological functions associated with large woody debris (LWD) are an important part of productive in-stream habitat. While riparian forests mature, certain management techniques in these areas can help tree-growing conditions to achieve the overall objective of growing larger diameter trees to contribute to long term riparian and in-stream habitat function. However, if thinning results in a residual stand below 180 TPA, the addition of LWD into streams is required except when DNR, in consultation with WDFW has granted a wood placement exemption. The LWD placement is intended to substitute for wood harvested under this template that otherwise had the potential to recruit to the stream. This strategy is intended to provide woody debris to the stream in the short term (< 50 years) until the remaining unharvested trees within the RMZ are available to naturally recruit to the stream over the long term (> 50 years). The LWD placement strategy is intended to encourage instream pool formation for fish habitat. However, woody debris placement should not create barriers to fish migration.

### **Large Woody Debris Placement Target**

Depending on site conditions, this strategy may require the placement of up to 4 pieces of LWD per 300 lineal feet of stream (approximately 4 pieces per acre of RMZ).

Small forest landowners are encouraged to consult with the SFLO for technical assistance in identifying the preferred locations for LWD placement. Among those sites that are appropriate, different restrictions or levels of consultation may be necessary. Technical staff can determine whether it is appropriate to place wood in the stream (taking into account stream size, sediment delivery concerns, etc.), help locate the most effective stream reaches for the placement of LWD, or determine if there is any need for additional LWD to be placed into the stream. At a minimum, the following locations should be avoided:

- Channels that have a history of debris torrents and/or other mass wasting activity.
- Channels that have a near-future likelihood of a debris torrent and/or other mass wasting activity.
- Locations immediately above permanent culverts.
- Confined channels where the valley floor width is less than twice the bankfull width (see Board Manual Section 2 for identifying CMZs and bankfull channel features).

#### Large Woody Debris Guidelines

The small forest landowner shall follow these guidelines for LWD placement:

- The priority for LWD placement, from high to low preference, is:
  - (a) Root wads with tree boles attached.
  - (b) Tree boles with no root wad.
  - (c) Root wads without tree boles attached.
- Larger diameter wood is preferred over smaller diameter wood. However, LWD should be representative of the trees removed from the riparian stand.
- Landowners are encouraged to leave limbs and branches attached to logs that are placed.
- Trees may be felled directly into the stream.
- Trees may be bucked, and the bucked pieces may be placed in the stream.
- It is recommended that the boles of trees or rootwads be placed such that they are partially in the water and partially on the bank.
- Large woody debris should be placed so that part of it is in the water at low summer stream flows as well as during high stream flows, to create pools and cover for fish.
- The wood should not be held in place by anchoring or cabling.
- No bank excavation should occur during wood placement.
- The placement of LWD will likely need to occur when the local fish spawning populations are absent. This typically occurs during summer and fall low water flow periods.

#### Type of Wood and Wood Quality

For this template, LWD is the available wood found on the property of a small forest landowner. The landowner may utilize any living or dead trees for LWD except those required to provide a live root mass to maintain bank stability. The first row of living trees adjacent to the edge of BFW or the CMZ provides bank stability to the stream. Do not use these trees as LWD.

Acceptable wood for LWD consists of:

- Conifer trees or logs, such as cedar, Douglas-fir, or hemlock. These are the preferred species for LWD placement because they will remain (i.e., decay slower) and will provide woody debris over a longer period. Hardwood or pine species should be avoided.
- Logs from trees felled at time of harvest or downed logs with a solid core. If logs are from an upland source, they must not include downed log requirements for wildlife as described in WAC 222-30-020(11). Downed logs and standing snags already within the RMZ should be

retained for wildlife habitat, floodplain function, and stand regeneration rather than moved into the channel.

- Trees, including root wads, harvested during road construction are a good source of LWD.

Minimum Wood Length

The length of logs placed in the stream should be at least two times the bankfull width of the stream. If the log has a root wad attached, the log length should be no less than 1.5 times the bankfull width of the stream. The SFLO, in consultation with the WDFW or a tribal representative, shall determine if shorter wood lengths are acceptable.

Minimum Wood Diameter

The placement of large diameter woody debris is encouraged if it is available. However, LWD should be representative of the trees removed from the riparian stand. At a minimum, a piece of LWD measured at the small end must be at least 4 inches in diameter.

This strategy does not require the placement of large dimensional wood into the stream, but placement of large wood is encouraged if it is available. While it is recognized that most trees harvested under this template will not be greater than 22 inches diameter breast height (dbh), the landowner may place LWD obtained from off site. The table below from Board Manual Section 26 gives guidance for optimal LWD piece size in different sized streams.

<b>BFW (in feet)</b>	<b>Minimum Diameter</b>
< 5 feet	12 inches
> 5 and < 16 feet	16 inches
> 16 and < 32 feet	22 inches
> 32 feet	26 inches

Restrictions to Riparian Zone Disturbances

Minimize ground disturbance from machinery to reduce sediment delivery to a stream. Disturbed soils with the potential to erode and directly deliver to the stream shall be treated with erosion control measures available and appropriate for the site. Appropriate control measures may include water bars, grass seeding, mulching, hay bales or silt fences.

The ELZ is 30 feet, measured horizontally, from the outer edge of the BFW or CMZ (see Board Manual Section 2). Equipment may operate within this zone, but soil disturbance within the ELZ from ground based equipment or cable-logging systems must not result in sediment delivery to the stream. If LWD placement activities could expose more than 10% of the soil in the ELZ, there is potential for sediment delivery to the stream and the landowner must consult with DNR a Forest Practices forester before placement.

Summary

Applying this template will allow small forest landowners to submit an alternate plan for a Western Washington overstocked conifer thinning prescription as part of a completed forest practices application (FPA). The FPA will be processed as an alternate plan as outlined in WAC 222-12-0401. The template form, must be included with the forest practices application, and is available through DNR. This form provides the technical justifications, as required in WAC 222-

12-0401(3)(b), (c), and (d), identifying how the alternate plan addresses the various functional requirements of the RMZ. Review of the proposed harvest may require an Interdisciplinary (ID) Team (see WAC 222-12-0401(5)). However, by adhering to the guidelines in this template, the need for an ID Team will be minimal and only necessary if specific issues arise.

## **Template 2. Fixed Width Riparian Buffers for Small Forest Landowner's in Western Washington**

### **Background**

Many small forest landowners find the forest practices process to determine if their timber stands are eligible for riparian inner zone harvest to be complex and expensive to implement. The effect can often be a loss of timber income.

### **Purpose**

Using this template offers small forest landowners a simplified “fixed width” riparian buffer option for Western Washington Type S and F Waters. The template establishes a fixed width riparian buffer equal, on average, to the buffer widths occurring when the model is applied to meet desired future conditions as provided in WAC 222-30-021. Providing a fixed width riparian buffer for small forest landowners using this template will also achieve the goal of WAC 222-30-010(2), “. . . to protect aquatic resources and related habitat to achieve restoration of riparian function; and the maintenance of these resources once they are restored.”

### **Process**

Landowners submit a fixed width riparian buffer template form, available from DNR. This form provides the technical justification required by WAC 222-12-0401(3) (b), (c), and (d), explains how the alternate plan enhances riparian function and provides details of the landowner's plan. The template form must be included with the forest practices application (FPA).

Landowners planning to conduct a harvest within a riparian management zone (RMZ) adjacent to Type S Waters (protected by the Shoreline Management Act, RCW 76.09.910) must consult with the city or county of jurisdiction to determine if the proposed activities comply with the local shoreline master plan. If a Substantial Development Permit is required, landowners must include a copy of the permit with the FPA.

As for any proposed Alternate Plan, an Interdisciplinary (ID) Team may be used to review the proposed fixed width riparian buffer (see WAC 222-12-0401(5)). However, by following the provisions in this template, an ID team will only be necessary if site-specific issues arise.

### **Eligible Stands**

This template can be used for RMZs that are:

- Adjacent to Type S and F Waters as defined in WAC 222-16-031; and
- Located in Western Washington.

### **Riparian Buffer Prescription**

This template establishes a fixed width, no harvest riparian buffer for Type S and F Waters. Use the following steps to determine the fixed width buffer for your stream:

1. Determine the outer edge of bankfull width (BFW) or the channel migration zone (CMZ), see Board Manual Section 2.
2. Determine the site class for the RMZ adjacent to the stream. To determine site class, download a Forest Practices Application/ Notification activity map for your area and activate the site class layer. Go to [http://www.dnr.wa.gov/BusinessPermits/Topics/ForestPracticesApplications/Pages/fp\\_forms.aspx](http://www.dnr.wa.gov/BusinessPermits/Topics/ForestPracticesApplications/Pages/fp_forms.aspx), and under the heading, “Forest Practices Application/Notification”, click on “Print an activity map.” After navigating to the location of your activity, in the left corner under the “Select a map” button, choose Site Class Map. In the upper right corner, click on the “Legend” button to find the site class of your activity.
3. Determine the width of the fixed width riparian zone using Table 1.
4. Establish the buffer on the ground by measuring horizontally from the outer edge of BFW or the CMZ, whichever is greater.

**Table 1**  
Fixed Width, No Harvest Buffer Widths by Site Class

<b>Site Class</b>	<b>No Harvest Zone width</b> (measured from outer edge of BFW or outer edge of CMZ)
I	145 feet
II	118 feet
III	101 feet
IV	82 feet
V	75 feet



## Section 22

# Guidelines for Adaptive Management Program

<b>PART 1. OVERVIEW</b> .....	1
Figure 1. The structure of the Adaptive Management Program .....	3
2.1 Forest Practices Board (Board).....	4
2.2 Timber, Fish and Wildlife Policy Committee (Policy Committee).....	4
2.3 The Cooperative Monitoring Evaluation and Research Committee (CMER).....	5
2.4 Adaptive Management Program Administrator (Administrator).....	6
<b>PART 3. ADAPTIVE MANAGEMENT PROGRAM PROCESS STAGES</b> .....	6
Figure 2. The AMP process is composed of six stages from initiation to management implementation. ....	7
3.1 Stage 1: Initiation and Screening of Proposals .....	8
3.2 Stage 2: Proposal Review and Planning .....	11
3.3 Stage 3: Proposal Implementation .....	12
3.4 Stage 4: Policy Committee Recommendation .....	13
3.5 Stage 5: Board Consideration of Action .....	14
3.6 Stage 6: Management Implementation .....	14
<b>PART 4. SCIENTIFIC PEER REVIEW PROCESS</b> .....	14
4.1 Purpose.....	14
4.2 Administrative Structure.....	15
4.3 What Will Be Reviewed .....	15
Table 1 Overview of the requirements for the scientific peer review process .....	15
4.4 Procedure for Peer Review .....	16
4.5 Other Products that May be Reviewed .....	17
<b>PART 5. DISPUTE RESOLUTION</b> .....	18
5.1 Introduction.....	18
5.2 The Stages of Dispute Resolution.....	18
5.3 Mediation or Arbitration.....	18
5.4 Guidance .....	19
Figure 3. Policy Decision Making Process for Non-CMER Proposals .....	20
<b>PART 6. RELATED PROGRAM ELEMENTS</b> .....	23
6.1 Biennial Fiscal and Performance Audits .....	23
6.2 Biennial/Compliance Monitoring .....	23
<b>Appendix A Adaptive Management Program Ground Rules</b> .....	24
<b>Appendix B Framework For Successful Policy/CMER Interaction</b> .....	28
<b>Appendix C Policy Work Group Charter Template</b> .....	33

## PART 1. OVERVIEW

### Background

The Washington State Legislature found that the 1999 Salmon Recovery Act and the resulting Forests and Fish Rules "...taken as a whole, constitute a comprehensive and coordinated program to provide substantial and sufficient contributions to salmon recovery and water quality enhancement in areas impacted by forest practices..." (RCW 77.85.180(2)). It also recognized that federal and state agencies, tribes, county representatives, and private timberland owners have spent considerable

effort and time to develop the Forests and Fish Report (RCW 76.09.055), and authorized the development of forest practices rules based on the analyses and conclusions of the Forests and Fish Report (FFR). The rules include the development of an adaptive management program to:

*. . . make adjustments as quickly as possible to forest practices that are not achieving the resource objectives . . . (and) shall incorporate the best available science and information, include protocols and standards, regular monitoring, a scientific and peer review process, and provide recommendations to the board on proposed changes to forest practices rules to meet timber industry viability and salmon recovery. (RCW 76.09.370(7))*

These provisions for the forest practices Adaptive Management Program are designed to meet the goals and objectives for water quality and fish habitat within the jurisdiction of the Forest Practices Program. Four goals listed in the FFR are:

1. To provide compliance with the Endangered Species Act (ESA) for aquatic and riparian-dependent species on non-federal forest lands;
2. To restore and maintain riparian habitat on non-federal forest lands to support a harvestable supply of fish;
3. To meet the requirements of the Clean Water Act for water quality on non-federal forest lands; and
4. To keep the timber industry economically viable in the State of Washington.

The Forest Practices Board (Board) recognizes that current scientific knowledge lacks the certainty to answer all the pertinent questions associated with the forest practices rules. The Board manages a formal Adaptive Management Program to ensure that rules and guidance not meeting aquatic resource objectives will be modified in a streamlined and timely manner.

### Introduction

This manual provides a technical advisory supplement to the Forest Practices Act to describe and provide guidance for the implementation and management of the Adaptive Management Program. The purpose of the program is to affect change when it is necessary or advisable to adjust rules and guidance for aquatic resources to achieve the goals of the Forest Practices Act or other goals identified by the Board. This is reflected in program resource objectives as described in WAC 222-12-045(2), which are aimed at ensuring that forest practices, either singly or cumulatively, will not significantly impair the capacity of aquatic habitat to:

- Support harvestable levels of salmonids;
- Support the long-term viability of other covered species; or
- Meet or exceed water quality standards (protection of designated uses, narrative and numeric criteria, and antidegradation).

The desired outcomes of the Adaptive Management Program include:

- Certainty of change as needed to protect covered resources;
- Predictability and stability in the process of change so that forest landowners, regulators and interested members of the public can anticipate and prepare for change; and
- Application of quality controls to scientific study design, project execution and interpretation of results.

**PART 2. ADAPTIVE MANAGEMENT PROGRAM PARTICIPANTS**

The forest practices rules in Title 222 WAC instruct the Board to manage three Adaptive Management Program participants: the Timber, Fish and Wildlife (TFW) Policy Committee or similar collaborative forum; the Cooperative Monitoring, Evaluation, and Research (CMER) Committee; and the Adaptive Management Program Administrator (Administrator). The Department of Natural Resources (DNR) operationally implements the Forest Practices Program.

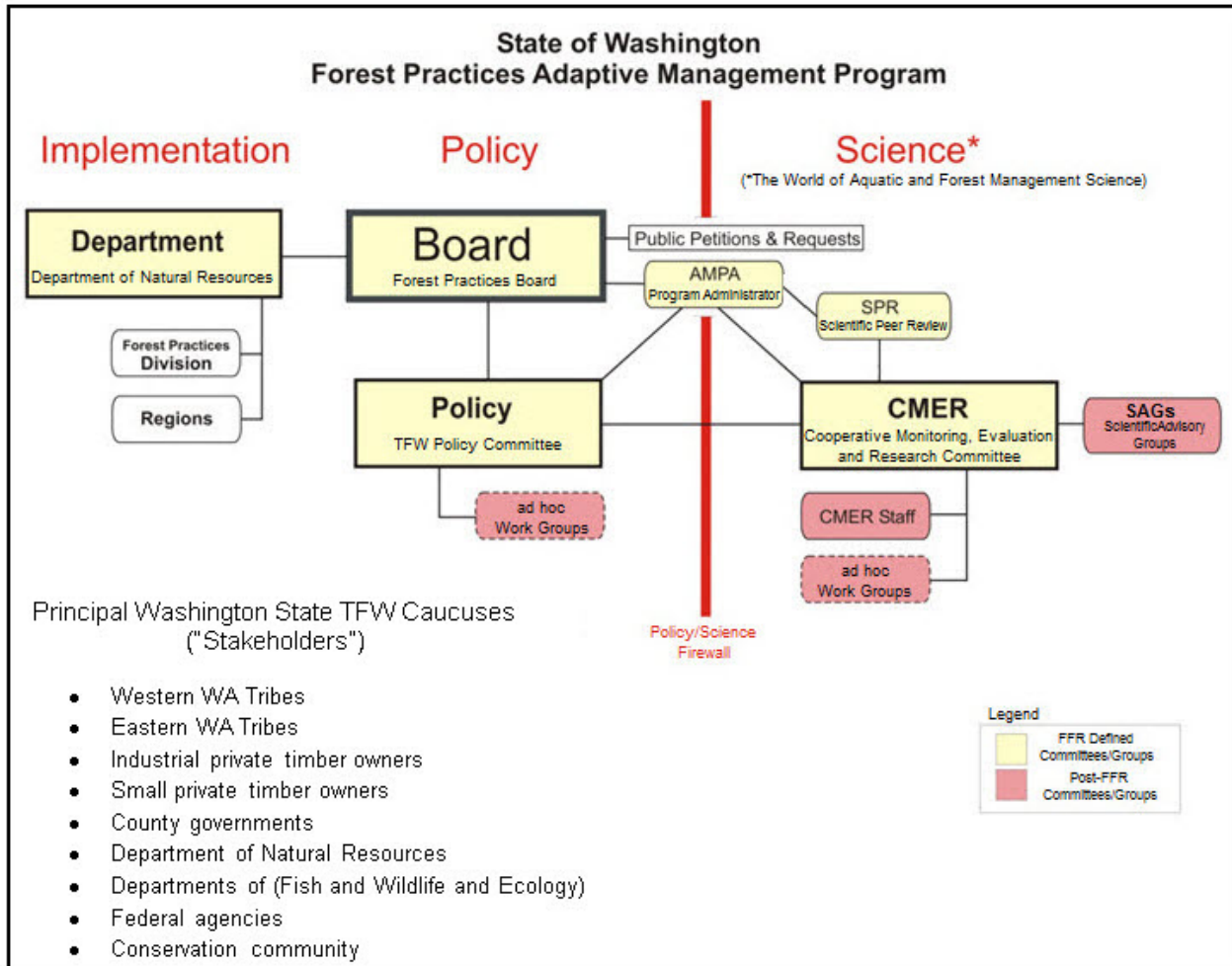


Figure 1. The structure of the Adaptive Management Program

The Adaptive Management Program is divided into three functions: Policy, Science, and Implementation. CMER reviews existing science and contributes original research to the program. The Policy Committee makes recommendations to the Board for decision. The Science function produces unbiased technical information for consideration by the Policy Committee and the Board, as illustrated by the interactive structure of the Adaptive Management Program in Figure 1. The Administrator coordinates the flow of information between the Policy Committee and CMER according to the Board’s directives. DNR implements and regulates forest practices per WAC 222-08-010. Feedback can be achieved through compliance monitoring and implementation statistics and reports that are generated from operational experience such as interdisciplinary teams and alternate plans.

## **2.1 Forest Practices Board (Board)**

The Board has approval authority over proposed CMER projects, annual work plans, and expenditures. It establishes resource objectives to inform and guide the activities of the program and sets priorities for action. If consensus or an otherwise acceptable conclusion is not reached during the dispute resolution process, the Board makes the final determination. The Board also:

1. Directs the program to complete work according to the CMER master project schedule;
2. Determines whether the program is in substantial compliance with the CMER master project schedule;
3. Notifies the National Marine Fisheries Service and the US Fish and Wildlife if the program is not in substantial compliance with the CMER master project schedule;
4. Approves nominations for CMER committee members;
5. Ensures that fiscal and performance audits of the Adaptive Management Program are conducted;
6. Forwards to the Adaptive Management Program all proposals affecting aquatic resources for new rules and board manual content; and
7. Approves proposed updates to Schedules L-1 and L-2, “Key Questions, Resource Objectives, and Performance Targets for Adaptive Management” (see Adaptive Management Program website at:  
[http://www.dnr.wa.gov/BusinessPermits/Topics/FPAdaptiveManagementProgram/Pages/fp\\_am\\_program.aspx](http://www.dnr.wa.gov/BusinessPermits/Topics/FPAdaptiveManagementProgram/Pages/fp_am_program.aspx).

## **2.2 Timber, Fish and Wildlife Policy Committee (Policy Committee)**

The Policy Committee or similar collaborative forum, is a consensus-based policy forum to support the Adaptive Management Program. The Policy Committee consists of members selected by and representing the following State of Washington TFW caucuses:

1. Industrial private timber owners
2. Nonindustrial (small) private timber owners
3. Environmental community
4. Western Washington tribal governments
5. Eastern Washington tribal governments
6. County governments
7. Department of Natural Resources
8. Departments of Fish and Wildlife and Ecology
9. Federal agencies (National Oceanic & Atmospheric Administration Fisheries, US Fish and Wildlife Service, and US Environmental Protection Agency)

The function of the Policy Committee is to develop solutions to issues that arise in the Forest Practices Program. These issues may be raised by science reports on rule or program effectiveness or policy questions on implementation of forest practices. Solutions may include the preparation of rule amendments and/or guidance recommendations.

The Policy Committee also assists the Board by providing guidance to CMER and recommendations on adaptive management issues. The Policy Committee reviews and makes recommendations on the key questions, resource objectives, and performance targets (Schedules L1 and L2), and recommends CMER program priorities for CMER work plans containing specific research projects to the Board. In cooperation with CMER, the Policy Committee reports to the Board the status of the CMER master project schedule prioritizing CMER research and monitoring projects and provides an update of the CMER master project schedule at least every four years.

For the purposes of implementing the Adaptive Management Program, The Policy Committee provides the forum for discussion and problem solving for the ongoing implementation of the Forest Practices Act and rules. This includes the development of board manual sections dealing with aquatic resources and matters relating to small landowner programs, adaptive management funding, and federal assurances of the DNR Forest Practices Habitat Conservation Plan (HCP). The Policy Committee's participation, decision-making process and working relationships are described in the Adaptive Management Program Ground Rules (Appendix A).

### **2.3 The Cooperative Monitoring Evaluation and Research Committee (CMER)**

The purpose of CMER is to advance the science needed to support adaptive management. For the Adaptive Management Program, best available science is considered to be relevant science from all credible sources including peer-reviewed government and university research, other published studies, and CMER research products. Applicable historic information, privately produced technical reports, and unpublished data may have value and are considered as long as they can be assessed for accuracy and credibility. CMER is responsible for understanding available scientific information that is applicable to the questions at hand, selecting the best and most relevant information and synthesizing it into reports for the Policy Committee and the Board.

CMER is composed of scientific representatives of TFW participating caucuses who are expected to maintain an objective scientific perspective. Participating representatives may be Board-approved members but participation is not limited to Board-approved members. To become a Board-approved member, a TFW caucus nominates a representative for Board approval (by contacting the Board's Rules Coordinator at 360-902-1400 or email at [forestpracticesboard@dnr.wa.gov](mailto:forestpracticesboard@dnr.wa.gov)). CMER operates on the basis of consensus of all parties, but if consensus cannot be reached a decision is limited to the Board-approved membership. Because CMER is charged with producing credible, peer-reviewed technical reports based on best available science and guided by the Monitoring Design Team report, participating caucuses are encouraged to nominate research scientists with publication experience and technical scientists with experience in conducting and reviewing research work.

CMER maintains and updates (for Policy Committee review and Board approval) the Forests and Fish key questions, resource objectives and performance targets (Schedules L-1 and L-2) and the CMER work plan. See Forest Practices Adaptive Management Program website at <http://www.dnr.wa.gov/AboutDNR/BoardsCouncils/CMER/Pages/Home.aspx> for a listing of current key questions, resource objective and performance targets.

The CMER work plan provides the integrated strategy for how CMER supports the Adaptive Management Program. The work plan identifies six objectives towards this goal:

1. State critical research and monitoring questions that are pertinent to evaluating rule, guidance, and DNR products (i.e., rule tools) effectiveness;
2. Organize these questions into coherent program groupings;
3. Assess feasibility, resource risk, and scientific uncertainty addressed by each program;
4. Develop an integrated strategy for accomplishing the work;
5. Rank programs/projects for implementation; and
6. Develop budget estimates and timelines.

The CMER work plan will also provide for periodic review of the design of the Forest Practices Program compliance monitoring program(s) to ensure that it will provide requisite information to

support the effectiveness and validation monitoring components of the Adaptive Management Program. Interpretation of the results of compliance monitoring will be conducted as part of each program/project that relies on it.

The details of CMER business are provided in the Protocols and Standards Manual, which is updated regularly and available at <http://www.dnr.wa.gov/AboutDNR/BoardsCouncils/CMER/Pages/Home.aspx>. Adaptive Management Program ground rules for CMER are presented in Appendix A.

#### **2.4 Adaptive Management Program Administrator (Administrator)**

The Administrator ensures the operation of an efficient, clear and open Adaptive Management Program that serves the needs of the Board. The Administrator works directly with the Board, the Policy Committee, and CMER to:

1. Respond to requests for adaptive management review.
2. Manage Adaptive Management budgets and contracts.
3. Communicate CMER research results to the Policy Committee and the Board.
4. Facilitate a Policy Committee or Board response to questions of policy interpretation that may arise in the course of CMER scientific work.
5. Assist in conducting CMER business.
6. Manage the Adaptive Management Program to include the research and monitoring projects and budgets.
7. Coordinate with the Board to ensure that its guidance and priorities are implemented and that the information and results produced by the Adaptive Management Program are effectively communicated to the Board.
8. Administer a science-based operation and facilitate the appropriate involvement of the independent scientific peer review process.
9. Coordinate dispute resolution.
10. Present to the Board, at least every two years, a progress report on the CMER master project schedule, project status, and a summary of the Policy Committee's responses to final CMER reports.

### **PART 3. ADAPTIVE MANAGEMENT PROGRAM PROCESS STAGES**

The Adaptive Management Program utilizes a six-stage process for managing program proposals (Figure 2). The six stages serve to “close the loop” when there is a need to adjust forest practices rules, guidance, or DNR products (i.e., rule tools). This system is used to guide participants in program expectations, provide standards to gauge where a proposal or product fits, and provide protocols to move proposals through the stages. The term “proposal” is used generically to identify any form of request, question, task, project, sub-program, etc., whose end product may affect changes in forest practices or otherwise meet one of the program's goals and objectives.

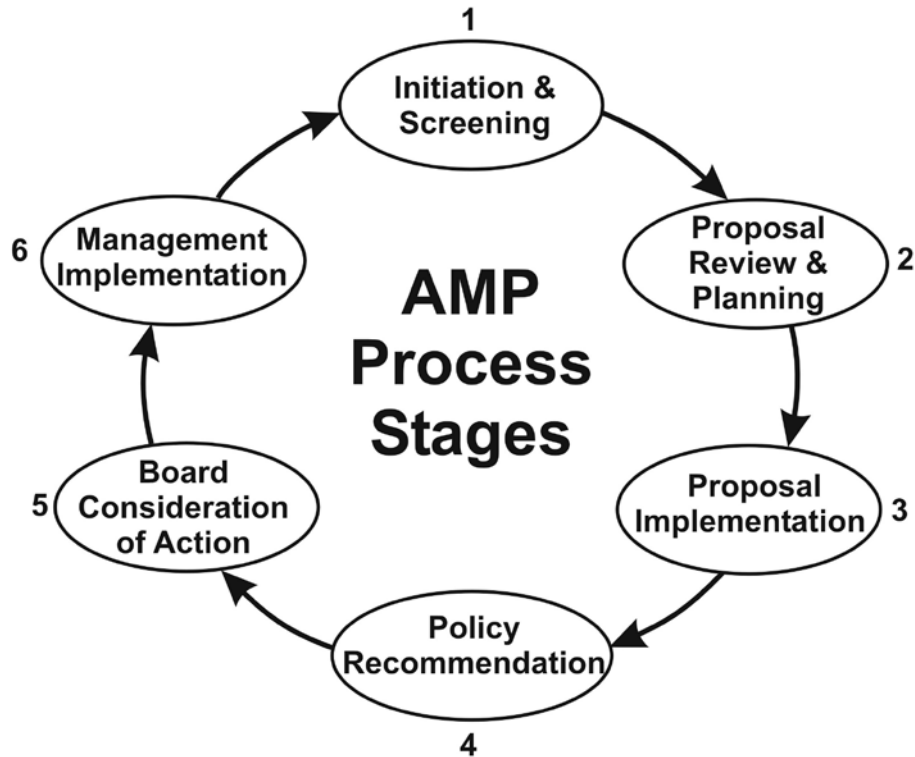


Figure 2. The AMP process is composed of six stages from initiation to management implementation.

This manual guides Adaptive Management Program participants toward conducting an efficient and effective process in a timely manner. It provides a stage-by-stage approach to take a proposal from initiation to implementation. It sets the minimum level of standards and protocols expected for successful participation in a multi-stakeholder, cooperative, and consensus-driven process. Guidance is also provided to identify the different Adaptive Management Program groups and committees available for addressing different proposals. Flexibility is allowed where alternative processes provide information of the same or higher quality. If participants cannot reach consensus at any stage, the issue may be addressed within the dispute resolution process as described in Part 5.

Proposals for the Adaptive Management Program process should be submitted prior to the first day of July to be considered for inclusion in the following year's fiscal work plan. This date is used to provide a systematic and consistent annual process, regardless of whether proposals require funding. Proposals submitted to the Administrator after the first day of July are at risk of not being considered in the subsequent fiscal year. All attempts will be made to ensure timely consideration of proposals.

It is expected that proposal funding will be structured in such a way that no interest can bias the scientific inquiry. Funding earmarked for a specific project or topic will be allowed if agreed to by the Policy Committee and the Board. External science studies may be brought to CMER:

- As part of the body of science reviewed by CMER in addressing work plan tasks; or
- Directly in the form of specific technical reports to be reviewed and reported on by CMER as directed by the Policy Committee or the Board.

### **3.1 Stage 1: Initiation and Screening of Proposals**

The listed projects in Schedule L-2 and the annual CMER work plan contain a list of currently proposed projects. Initiation of additional projects is dependent upon screening and available funds.

Proposals are initiated as requests for investigation of potential changes to forest practices rules, guidance, or DNR products. In general, the types of proposals considered for the Adaptive Management Program are requests for:

- Research and monitoring of scientific uncertainty and resource risks;
- Policy interpretations and modifications to improve forest practices management and aquatic resource protection; and
- Review of completed technical studies or issue analyses for consideration in the adaptive management program.

#### **Proposal Initiation**

An Adaptive Management proposal can be initiated by:

- The Board, including actions taken in response to public requests; or
- Any Adaptive Management Program participant, through the Administrator.

The general public may present a proposal at a Forest Practices Board meeting. A schedule of the Forest Practices Board meetings is found at:

[www.dnr.wa.gov/BusinessPermits/Topics/OtherInteragencyInformation/Pages/bc\\_fp\\_agendas\\_minutes.aspx](http://www.dnr.wa.gov/BusinessPermits/Topics/OtherInteragencyInformation/Pages/bc_fp_agendas_minutes.aspx).

All proposals from the Board (including public requests) or an Adaptive Management Program participant are submitted to the Administrator who will assure that the proposal identifies:

1. The affected forest practices rule, guidance, or DNR product;
2. The urgency based on scientific uncertainty and resource risk;
3. Any outstanding TFW, FFR, or Policy Committee agreements supporting the proposal;
4. How the results of the proposal could address Adaptive Management Program key questions and resource objectives or other rule, guidance, or DNR product; and
5. Available literature, data and other information supporting the proposal.

Proposals may also include:

1. The proposal's testing hypotheses and assumptions;
2. A description of affected public resources;
3. Potential cause and effect relationships with forest practices management;
4. A description of the proposal's study design; and
5. An estimated timeline with milestones and costs associated with implementation of the proposal.

#### **Assess Adaptive Management Program applicability**

The Administrator assesses a proposal for its applicability and relevance to the Adaptive Management Program, i.e., whether it would affect how forest practices are conducted with respect to aquatic resources, or whether it is a directive from the Board to include within the Adaptive Management Program.

The Administrator considers outstanding agreements (see note below) including any formal agreements from TFW (1987), FFR (1999), or current Policy Committee agreements related to the issue, and determines if they are interpreted correctly in the proposal.



*Note: Outstanding agreements are negotiated actions that have been approved and allowed within the adaptive management process prior to the start of a proposal or completion of a project. Documentation of agreements and authorities supporting a proposal are of high value in defining the context, expectations, and findings of an adaptive management project. This can range from specific language expected to become permanent rule to general language used to identify the framework for future actions.*

#### Assess management and resource implications

The Administrator determines a proposal's applicability to the Adaptive Management Program by assessing for management and resource implications based on the Framework for Successful Policy Committee/CMER Interaction (Appendix B). Using this process, the Administrator provides a coarse-level estimate of expected end results, including a range of possible results that may be associated with each proposal. This assessment of management implications may cover spatial and temporal scales, landowner costs, agency management costs, programmatic costs and potentially affected programs. The framework provides a standard process for assessing a project over its life in the Adaptive Management Program.

The Administrator considers the following questions:

1. Is the proposal intended to inform a key question, resource objective, or performance target from Schedule L-1?
2. Is the proposal intended to implement projects listed in Schedule L-2?
3. Is the proposal intended to inform the forest practices rules, guidance, or DNR product? Is the specific rule, board manual section, DNR product, or effectiveness of compliance monitoring cited and key language provided correctly? If the proposal is for a new forest practices rule, does it fill a gap? If so, would it fit within the current forest practices structure?
4. If the proposal includes a completed study, was the study carried out using protocols and standards similar to CMER (i.e., study design, peer review)?
5. What would/does the study tell us?
6. What would/does the study not tell us?
7. What is the relationship between this proposal and any other studies that may be planned, underway, or recently completed? Cite the information and provide a coarse assessment of the literature, data, or other scientific information provided and determine whether any of the literature or data has been peer reviewed. Identify whether the literature or data is applicable to Washington State forest practices issues. Factors to consider in answering this question include, but are not limited to:
  - Feasibility of obtaining more information (within or outside Adaptive Management Program) to better inform the Policy Committee about resource effects.
  - Whether other studies reduce uncertainty.
8. How much of an incremental gain in understanding would/do the proposal results represent? Explain how the proposal results might affect the current rules, numeric targets, performance targets, or resource objectives.

*Note: The science underlying the current forest practices may be characterized based on a review of eleven best available science elements including: a) scientific information source; b) spatial scale; c) temporal scale; d) study design; e) methods; f) data; g) quantitative analysis; h) context; i) references; j) logical conclusions and reasonable inferences; and k) peer review.*

In addition to the questions above, the Administrator identifies and describes any urgency for the proposal based on the scientific uncertainty, resource risk and other factors.

Assess proposal development track

For each proposal, the Administrator recommends a proposal development track to the Policy Committee based on the nature of the proposal and amount of information provided. Proposals will generally follow one of two tracks: scientific or policy. Proposals requiring scientific assessment or analysis are directed toward the science track. Proposals seeking to change or clarify policies or change the way existing science is implemented in the rules are directed toward the policy track.

*Science track:* The science track evaluates currently available science, collects new information through research and monitoring, and synthesizes the best available information into a technical summary for the Policy Committee’s consideration. In all cases CMER is responsible for conducting synthesis of research and monitoring information and for producing reports to Policy.

At this stage in the process, the Policy Committee will direct CMER to respond to one of three questions:

- What would it require to develop and implement this study?
- What would it require to approve the study design?
- What would it require to analyze and synthesize the study results?

*Policy track:* Proposals recommended for Adaptive Management Program development following the policy track are those related to interpretation and implementation of the TFW Agreement or the FFR.

Assemble and present proposal review packet to the Policy Committee

The Administrator provides to the Policy Committee:

- Summary of proposal;
- Recommendation of applicability and value to the Adaptive Management Program including identifying those proposals that should not be included in the process;
- Recommendation of proposed track for Adaptive Management Program development.

Policy Screening and Recommendation

*Evaluating proposals:* During this stage, the Policy Committee has the opportunity to deliberate over proposals considering the information provided by the Administrator. The Policy Committee may engage in discussions with the Administrator regarding the designated tracks and quality of information provided for each proposal. The Policy Committee will consider budget implications and potential impacts of the proposal on the CMER work plan in the initial project screening.

*Screening decisions on proposals:* The Policy Committee considers proposals for their relevance and suitability to the Adaptive Management Program as well as timing of implementation, including urgency and appropriate sequencing. The Policy Committee strives for consensus on a comprehensive annual Adaptive Management Program package and either:

- Recommends to the Board that the proposal be rejected; or
- Accepts the proposal and assigns it to a specific track in the CMER or the Policy Committee work plan.

*Administrator Coordination:* The Administrator coordinates action and communicates between the Board, the Policy Committee and CMER, and delivers the recommendation for rejection of proposals to the Board. Where the Board disagrees with a Policy Committee recommendation, the Administrator notifies Policy and coordinates action as directed by the Board.

### **3.2 Stage 2: Proposal Review and Planning**

If the Policy Committee accepts proposals in Stage 1, Stage 2 begins. Stage 2 includes: development by track; administrator assessment and synthesis; the Policy Committee's recommendations; administrator assessment and synthesis; Board consideration for action; and administrator coordination. The end product of Stage 2 is a Board-approved annual CMER work plan and budget from which proposals will be considered for implementation.

#### Development by Science Track

Each Adaptive Management Program proposal is developed according to the following guidelines and it is recommended that proposal development be accomplished within 90 days.

#### Science track proposal: development, review and planning

Proposals in the science track will follow the guidelines provided in the CMER Protocols and Standards Manual. At a minimum, for each proposal, CMER will review and, as necessary, revise the Administrator's initial screening and synthesis. Refinements will be provided in the CMER work plan.

Proposals that involve gathering new data or new analysis of existing data must include the following elements:

1. A description of the scientific basis of the current rule or guidance;
2. An estimate of the degree to which knowledge or understanding will be improved if the proposal is implemented;
3. A detailed description of the actions required to achieve the improved knowledge or understanding, including peer review;
4. An estimate of the human resources required to implement a proposal; and
5. A budget and timeline.

Those technical proposals that provide completed scientific reports and involve neither gathering new data nor original analysis of existing data (i.e., proposals that purport to require only Stage 4 action by the Policy Committee) will include the CMER review of the following elements:

- An assessment of the validity and applicability of the science;
- Whether peer review should be conducted; and
- A budget and timeline.

In addition, CMER will make a recommendation to the Policy Committee and the Board on all proposals regarding their relative importance in the annual CMER work plan.

#### Administrator assessment and synthesis

*Package proposals and budget:* The Administrator receives the developed science proposals, assesses the information for completeness, and synthesizes the information into a single annual CMER work plan proposal and budget. The Administrator has until the first working day of February to complete this package.

*Present CMER Work Plan to the Policy Committee:* The Administrator presents the draft annual CMER work plan to the Policy Committee two weeks prior to the regularly scheduled March meeting when the Policy Committee will deliberate the work plan.

Policy Committee recommendation

The Policy Committee reviews the CMER work plan and may either approve or revise it. The Policy Committee documents the revisions and includes an explanation of the revisions. In preparation for May Board action, the Policy Committee has until the first working day of April to provide the recommended revised CMER work plan to the Administrator.

Administrator work plan presentation

The Administrator has until the second Wednesday of April to provide the recommended revised CMER work plan to the Board.

Board consideration for action

The Board, utilizing recommendations from the Policy Committee and the Administrator’s evaluations, makes the final determination regarding the proposals and work plan, including approval and prioritization.

Administrator coordination

The Administrator coordinates the Board-approved proposals and prepares the completed Fiscal Year CMER work plan. All Board-approved proposals from Stage 2 will be forwarded to Stage 3 Implementation processes.

Development by Policy Track

For each proposal in the policy track, the Policy Committee will create a workgroup composed of committee participants and caucus staff to develop a charter (Appendix E). The charter will include the following elements:

1. A description of the current policy and a brief description of how it was developed;
2. A description of the benefits of the policy proposal;
3. Actions required to develop the policy proposal;
4. A schedule of dates for workgroup submission of progress reports to the Policy Committee;
5. An estimate of the human resources to develop the proposal; and
6. A budget and timeline.

The Policy Committee’s approved charter will be included in the proposal work plan. The Policy Committee will forward the charter to the Board for informational purposes.

**3.3 Stage 3: Proposal Implementation**

The proposal implementation stage includes the practical implementation of the work plan and the assessment and synthesis of the results into a findings report.

Implementation by CMER Track

Proposals in the Board-approved annual CMER work plan will be delegated as appropriate for implementation. The Administrator will coordinate the initiation of the implementation process with the various groups based upon the Policy Committee and Board direction and details provided in the work plan.

Funding will be made available for approved work plan projects through DNR contracting services following agency and state Office of Financial Management (OFM) requirements. This often requires development of a scope of work on which the contract is based. The Administrator is responsible for management of this process.

CMER implementation

Approved proposals will be implemented following the guidelines in the CMER Protocols and Standards Manual.

Assessment and synthesis

Upon approval of a final study report, CMER develops a findings report. The findings report includes the CMER-approved final study report, answers to the CMER/Policy Committee framework questions 1 through 6 (Appendix B), and all technical implications generated through the CMER consensus process. Findings reports should be completed within 3 months of CMER approval of final study reports.

Administrator analysis and transmittal to the Policy Committee

The Administrator assesses the findings report for completeness and adds a discussion of the forest practices rule and/or guidance implications to the CMER findings report. The Administrator discusses questions regarding completeness with CMER prior to presenting the findings report to the Policy Committee. The Administrator then submits the completed findings report within one month to the Policy Committee for consideration of recommendations to the Board.

Implementation by Policy Track

The Policy Committee plans and implements approved proposals delegated to the Policy Committee based on the charter approved for each proposal and guided by the principles of the Adaptive Management Program. Upon completion of a final product as defined by the charter, the Policy Committee workgroup develops a recommendation for the Policy Committee. This should occur within one month of product completion.

**3.4 Stage 4: Policy Committee Recommendation**

Upon receipt, the Policy Committee has up to 180 days to develop a decision whether consensus or not and then make a recommendation to the Board. Working with the Administrator, the Policy Committee recommendations to the Board will be accompanied by a formal petition for rulemaking in accordance with WAC 222-08-100 and RCW 34.05.330 or a non-rulemaking alternative action. The Policy Committee may also recommend that the Board take no action. The Policy Committee's consideration of all products from Stage 3 will be based on the *Framework for Successful Policy Committee/CMER Interaction* (Appendix B).

Policy Committee's Decision to Take Action

The Policy Committee determines by consensus whether any action should be taken in response to the information provided. Upon receipt of the findings report, the Policy Committee has 45 days to review the findings and to make a consensus decision as to whether the information merits taking action or not. A no action consensus skips the Policy Alternatives step and goes to the Final Policy Committee Consensus step. The Policy Committee consensus for taking action will initiate the development of action alternatives.

### Policy Committee Alternatives

The Policy Committee analyzes the alternative courses of action and determines an appropriate management response. Alternatives will include information necessary to show whether the proposal is scientifically credible, operationally practical and administratively feasible. The Policy Committee has 60 days to develop appropriate alternative courses of action, and an additional 45 days to reach a consensus decision on an alternative to recommend to the Board.

### Final Policy Committee Consensus

The Policy Committee determines by consensus whether to make an adaptive management recommendation to the Board. In making a recommendation the Policy Committee will be mindful of factors that the Board will need to consider when making a decision. These factors include the FFR goals (listed in Part 1, Adaptive Management Program Overview) and statutory direction in chapter 76.09 RCW. If the Policy Committee has agreed upon an alternative, the Policy Committee finalizes its recommendations within 30 days and gives them to the Administrator for delivery to the Board. If the Policy Committee has not agreed upon an alternative, any Policy Committee caucus may invoke the dispute resolution process (see Part 5 Dispute Resolution).

### Policy Committee Recommendations to the Board

Recommendations to the Board should include:

1. Specific recommendations and/or alternatives developed by the Policy Committee;
2. Any final CMER report, Policy Committee product, and/or the Administrator discussion report of potential implications to the rules and guidance;
3. Any appropriate scientific peer review reports and documentation;
4. Any other information or reports as appropriate specifically generated as a result of the Adaptive Management Program process related to the original Board approved proposal of concern;
5. Draft rule language when appropriate to the recommendation; and
6. Minority and majority reports on issues lacking consensus.

### Administrator Coordination

The Administrator will provide coordination in the development and presentation of the Policy Committee's report to the Board.

### **3.5 Stage 5: Board Consideration of Action**

The Board will consider recommendations presented by the Policy Committee and consider action to be taken. See Board meeting minutes at <http://www.dnr.wa.gov/forestpractices/board/> for a status of actions taken.

### **3.6 Stage 6: Management Implementation**

DNR is responsible for implementing new rules and guidance. Performance audit protocols should be modified (see also Part 6.1) to reflect and report on new rules and guidance.

## **PART 4. SCIENTIFIC PEER REVIEW PROCESS**

### **4.1 Purpose**

WAC 222-12-045(2)(c) “establishes an independent scientific peer review process to determine if the scientific studies that address program issues are scientifically sound and technically reliable; and provide advice on the scientific basis or reliability of CMER’s reports.”

The purpose is to:

1. Clarify which adaptive management products and recommendations require independent scientific peer review;
2. Identify products or situations where peer review or other technical consulting services are suggested;
3. Outline the basic review procedures for each type of product; and
4. Help define responsibilities for CMER and other adaptive management participants throughout this process.

The scientific review process should not be used as a substitute for dispute resolution.

#### **4.2 Administrative Structure**

Scientific review is conducted in a manner similar to the peer review process used by many scientific journals. Peer review is conducted in an independent scientific peer review process established by the Board. This manual uses the functional names and nomenclature common to the peer reviewed journal process.

The Administrator coordinates the peer review process between the report authors, CMER, and an appointed Managing Editor. The Managing Editor initially reviews CMER reports and assigns them to an Associate Editor having expertise in the appropriate scientific field. The Associate Editor then selects 2-3 individual reviewers to perform the actual review of the document.

The Managing Editor is also responsible for maintaining a database of reviewers by area of expertise, and evaluating the Associate Editors and reviewers' performance. CMER, the Policy Committee, and the Board may determine other duties of the Managing Editor.

#### **4.3 What Will Be Reviewed**

Final reports of CMER funded studies, certain CMER recommendations, and pertinent studies not published in a CMER-approved, peer-reviewed journal are reviewed in the scientific peer review process. Other products that may require review include, but are not limited to, external information, work plans, requests for proposal, subsequent study proposals, a final study plan, and progress reports as described in WAC 222-12-045(2)(c). Table 1 provides a summary of what will be reviewed as part of the scientific peer review process.

**Table 1**  
**Overview of the requirements for the scientific peer review process**

<b>Review Process</b> (will include expert panels or as otherwise approved by the Administrator)	<b>Must be Reviewed</b>	<b>May be Reviewed</b>
Double-blind Review	<ul style="list-style-type: none"> <li>▪ CMER final reports</li> <li>▪ Pertinent studies in non-approved journals</li> <li>▪ Certain CMER recommendations</li> <li>▪ unpublished reports</li> </ul>	<ul style="list-style-type: none"> <li>▪ External information</li> <li>▪ Work plans</li> <li>▪ RFPs</li> <li>▪ Progress reports</li> <li>▪ Literature reviews</li> </ul>
<i>Interactive Review</i>		<ul style="list-style-type: none"> <li>▪ Study plans</li> <li>▪ Literature reviews</li> </ul>

#### **4.4 Procedure for Peer Review**

##### **Approach**

Products requiring formal peer review should undergo the double-blind approach where both the authors and the reviewers remain anonymous. This approach is a generally accepted method used by most scientific journals.

##### **Background Information and Review Questions**

After CMER approves a final project report, CMER may prepare additional background information and a list of specific questions for the peer reviewers to address. These questions may outline known problems or areas of uncertainty that reviewers should pay particular attention to. Questions submitted for peer review must be approved by CMER and should only address technical issues. Questions related to policy issues should be referred to the Policy Committee. If CMER cannot gain consensus on these additional materials, the issue is forwarded to the Policy Committee for dispute resolution.

##### **Administrator Initiates the Peer Review**

CMER sends the final CMER project report and any review questions to the Administrator. The Administrator reviews all materials to ensure that the submittal is consistent with CMER protocol. The Administrator prepares a transmittal letter that may incorporate additional background information or review questions, and forwards all materials to the Managing Editor of the scientific peer review process.

##### **Scientific Peer Review**

The Managing Editor receives materials from the Administrator, evaluates their readiness for review, and then transfers them to the appropriate Associate Editor. The Associate Editor selects a panel of two or three reviewers from a list developed by the Managing Editors, with nominations from Associate Editors and CMER.

A final CMER project report undergoes double-blind peer review in which both the authors and the reviewers remain anonymous. Each reviewer independently reviews the material, responds to any specific review questions, and provides comments and recommendations to the Associate Editor. The Associate Editor then summarizes all reviewer comments into a separate synthesis report that identifies the key observations, provides general suggestions, outlines any contradictions in comments, and includes a recommendation for addressing contradictions. If the individual reviews are inconsistent, the Managing Editor, the appropriate Associate Editor and an outside Associate Editor(s) address and resolve the inconsistencies. It should be noted that while synthesis reports are disclosable under public disclosure law, confidentiality of the reviewers and their individual comments is maintained.

The Associate Editor forwards the synthesis report, together with the individual reviewer comments, to the Managing Editor. The Managing Editor then returns the document to the Administrator who forwards it to the authors and CMER.

##### **Review Response Action Plan**

CMER prepares a “Review Response Action Plan” in response to the peer review comments by working with the report authors to evaluate all peer review comments and defining the appropriate actions (if any). CMER is not obligated to incorporate all the changes suggested by the peer review,



but must acknowledge the comments received, indicate how it will respond, and provide rationale for its response. CMER identifies any suggested document revisions and/or actions that stem from the peer review by a consensus process. If CMER cannot reach consensus, it will forward the Action Plan to the Policy Committee for review and resolution.

#### Special Considerations for Literature Reviews

Literature reviews should be peer reviewed since they can strongly influence the direction of subsequent research and monitoring programs. Peer review of a literature review will follow a similar process as final reports. However, these peer reviews will typically focus on whether the literature review overlooked relevant literature, and whether conclusions or synthesis recommendations are supported by the literature reviewed.

#### Special Considerations for Certain CMER Recommendations

CMER may respond to policy issues in various ways that may include workshops, literature reviews, white papers, recommendations for additional research, etc. The products of these efforts are subject to peer review. When sufficient and credible data are available for any given issue or question, CMER prepares a recommendation package that is based on the best available science (e.g., this may include the results of CMER research as well as other research). After the Policy Committee reviews the CMER recommendations, it has the option of requesting peer review to evaluate the scientific content of the report. The review of CMER recommendations to the Policy Committee is similar to other peer review except the review is initiated by the Policy Committee.

### **4.5 Other Products that May be Reviewed**

- Reports and articles from journals not approved by CMER and unpublished reports must be peer reviewed prior to their use in adaptive management decisions.
- Reports and CMER products that have a science question within them may be reviewed. The decision to peer review these products is based on whether additional scientific expertise is needed.
- Review of study plans/designs is recommended to help identify potential problems prior to releasing funds or collecting any actual data. This early project phase can benefit from open and iterative interaction between the authors, reviewers, and others. Unlike the double-blind peer review process, this approach provides more of a consulting service where all parties agree to face-to-face meetings or other interactions where the identity of the authors and reviewers may be revealed.

The Administrator and the Associate Editor coordinate the open review process. They identify specific questions or issues to be addressed during interactive sessions and communicate them to study plan authors and CMER-appointed reviewers. CMER-appointed reviewers may interact directly with the study plan authors and other CMER-appointed reviewers. Interactive sessions will generally be conducted by phone conference or, in special cases, in face-to-face meetings.

In some cases, the reviewers may be asked to participate in development or refinement of the study plan by addressing unresolved questions in the study plan development process, or by bringing their expertise to bear on specific technical questions. In other cases, the authors may only want the opportunity to discuss specific comments with reviewers for clarification. The products of an open review may be similar to those of a blind review, i.e., reviewers comment and an Associate Editor synthesizes, or the products may be specifically tailored to the particular project.

## **PART 5. DISPUTE RESOLUTION**

### **5.1 Introduction**

CMER and the Policy Committee operate most effectively in the collaborative consensus-based approach of the TFW process. However, an important feature of the Adaptive Management Program is specified time allotted for decision-making at critical junctures and the Policy Committee's consideration related to the effectiveness of forest practices rules. Time certainty ensures that management will respond to scientific information in an appropriate and timely manner to close the adaptive management loop.

Adaptive management under the forest practices rules is a process that contains many decision points. CMER and the Policy Committee are respectively charged with conducting scientific and policy review of specific forest practices rules and forwarding recommendations to the Board as to effectiveness of those rules. Decisions must be reached at CMER and at the Policy Committee at each step along the way in order for the program to function. For the most part, consensus decisions are routine and non-controversial. However, in an arena where aquatic resource protection necessitates some level of restriction of forest practices activities and where changes to established rules could have a significant economic impact on forest owners or pose a significant risk to the aquatic resources, disputes can arise at many decision junctures. Left unresolved, disputes could slow or stop the adaptive management process by delaying recommendation or preventing them from reaching the Board altogether. Unless mandated by legislative action or court order, the Board cannot act to change aquatic resource related forest practices rules outside the adaptive management process (RCW 76.09.370)..

Part 5 provides guidance for Adaptive Management dispute resolution under forest practices rules WAC 222-12-045(2)(h). The purpose of dispute resolution is to provide a time sensitive structure to the decision making process where routine methods for reaching consensus are not successful. The primary objective of the process outlined here is to achieve consensus. The rules establish dispute resolution as a staged process that provides two structured opportunities for the participants to reach agreement before a dispute is taken to the Board for resolution in the form of a petition as outlined in WAC 222-08-100.

### **5.2 The Stages of Dispute Resolution**

Adaptive management dispute resolution can involve up to two stages. The CMER and Policy Committee may utilize mediation or arbitration as outlined in Parts 5.3 and 5.4 below.

Stage 1: Resolve issues within two months. Any party may move the process to Stage two after an issue has been in dispute resolution for two months.

Stage 2: Complete mediation or arbitration within three months following initiation of Stage 2.

If consensus is not reached at Stage 2 by CMER or the Policy Committee, the dispute is forwarded to the Policy Committee or the Board respectively.

Stage 1 and 2 time limits may be extended by CMER or the Policy Committee by consensus if substantive progress is being made.

### **5.3 Mediation or Arbitration**

CMER or the Policy Committee may use mediation or arbitration to resolve disputes. Mediation

involves a professional mediator to organize and manage discussions between or among the parties with the clear purpose of reaching consensus on an issue. If mediation is successful, the results are recorded and sent to the Administrator for notice to either the Policy Committee (in the case of CMER) or the Board (in the case of a Policy Committee dispute).

Although arbitration is normally a binding process similar in many ways to the judicial system, within the adaptive management process, the results of arbitration can be binding only if parties agreed prior to arbitration to be bound. Arbitration in this context is a method for employing a third party to provide an informed and reasoned assessment of disputed issues(s). If the Policy Committee utilizes arbitration to resolve a dispute, the arbitrator transmits his or her results to the Administrator and the Administrator takes results of arbitration to the Board. In the case of CMER, the Administrator transmits the arbitrator's results to the Policy Committee. In cases of Board initiated CMER projects, the Administrator transmits it directly to the Board.

#### **5.4 Guidance**

The following guidance for conducting dispute resolution is divided into three sections. The first covers initiation of dispute resolution. The second section provides guidance for CMER and the Policy Committee on conducting Stage 1 dispute resolution and the third section contains guidelines for CMER and the Policy Committee for conducting Stage 2. In the case of a dispute in CMER, if dispute resolution is not successful the Administrator transmits the information to the Policy Committee. In the case of a dispute in Policy Committee, if dispute resolution is not successful the Administrator transmits the information to the Board.

#### **Initiating Dispute Resolution**

1. Dispute resolution may be initiated within CMER or the Policy Committee.
2. The dispute resolution process can be initiated when CMER or the Policy Committee fails to reach consensus on an issue and that failure of agreement prevents a project or a recommendation from moving forward to the next step. When a CMER or Policy Committee member feels that ordinary discussion and debate of an issue has been exhausted without satisfactory resolution they may initiate dispute resolution.
3. A Board approved CMER member or Policy Committee caucus can initiate dispute resolution by making a formal request to the co-chairs of these respective committees. If the request for dispute resolution is on the advance agenda of a meeting and is requested at the meeting with a written or verbal statement sufficient to clarify the nature of the dispute, this meeting date will constitute initiation of dispute resolution. If there is disagreement over the framing of the issue by the member initiating dispute resolution or other members, the disputants, along with the chair/co-chairs of the responsible committee, in consultation with the Administrator, will further clarify the dispute and agree on the issue in writing within 30 days (See figure 3, Policy Decision-Making Process for Non-CMER Proposal). If the request for dispute resolution is not on the advance agenda of the meeting, initiation of formal dispute resolution can occur at the next regularly scheduled or special meeting of the respective committee. The initiation of dispute resolution should be recorded in the committee meeting minutes.
4. The CMER or Policy Committee co-chairs should immediately inform all committee members that formal dispute resolution has been initiated.

**Policy Committee Decision-Making Process for Non-CMER Proposal**

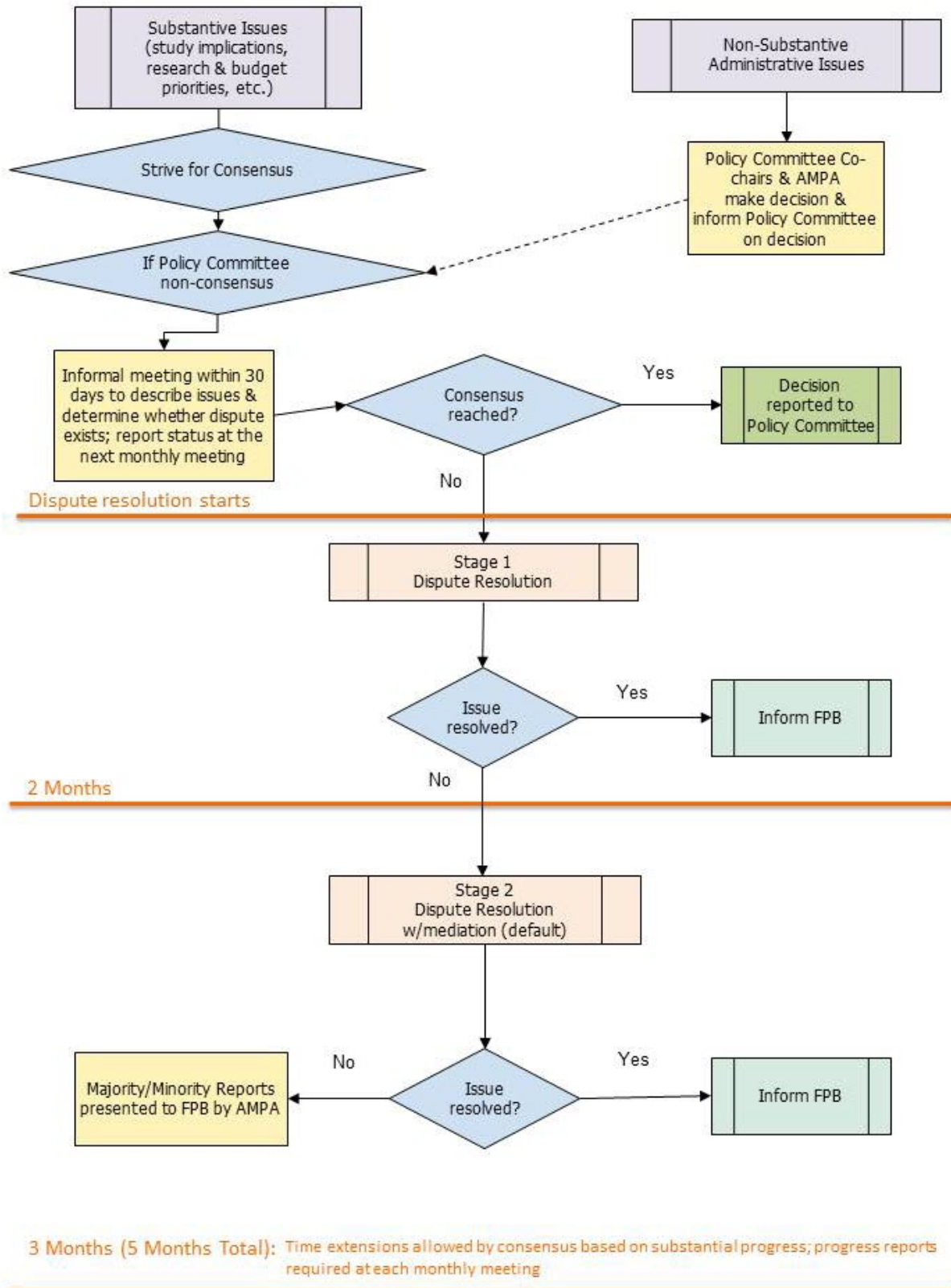


Figure 3. Policy Decision Making Process for Non-CMER Proposals

Guidance for Dispute Resolution Stage 1

*CMER*

1. As a body, CMER may have to conduct dispute resolution on issues presented by a Scientific Advisory Group or on issues originating in CMER.
2. CMER has a maximum of two months following formal initiation of dispute resolution to resolve the dispute in Stage 1. For technical disputes, if CMER cannot resolve the dispute in Stage 1, they move to Stage 2 mediation or arbitration.
3. CMER co-chairs should get disputes on the agenda as soon as possible after they are informed that a member wishes to initiate dispute resolution.
4. The CMER role in dispute resolution is to attempt to reach consensus on technical issues. Non-technical CMER issues will be referred to the Administrator (CMER Protocols and Standards Manual), while policy issues raised at CMER will be referred to the Policy Committee. CMER must decide quickly whether the issue brought forward for dispute resolution is a technical issue that CMER can resolve or a policy issue that should be forwarded to the Policy Committee. If the Administrator, in consultation with the CMER co-chairs, determines the dispute cannot be resolved through technical review and discussion because it is in fact a policy issue, the Administrator should immediately turn the issue over to the Policy Committee for consideration.
5. The CMER co-chairs, with the guidance and assistance of the Administrator, are responsible for setting up a dispute resolution discussion and can employ a variety or combination of methods to attempt to resolve the dispute. The method selected and the time period available for resolution should be announced to CMER via e-mail before the first meeting that the issue is scheduled to be discussed. The following are suggested methods for CMER co-chairs to seek resolution. Other methods not listed may be equally effective.
  - Place the dispute on the agenda where it will be aired and the group will attempt to come to consensus through a normal chair-facilitated discussion.
  - Ask for and distribute written discussions of the disputed issues and potential solutions from the party or parties requesting dispute resolution and response from those with opposing views. This exchange would have to be scheduled so that discussion leading to potential consensus could occur on time.
  - Ask an impartial volunteer from the group to mediate the dispute and facilitate an attempt to reach consensus.
  - Add a fact-finding or research step to any one of the above methods to insure that the decisions of CMER are properly informed on the issues of the dispute. Fact-finding would have to be scheduled so that discussion leading to potential consensus could occur on time.
  - Arrange for discussion outside of formal CMER meetings to facilitate agreement among disputing parties.
  - Reach consensus on a customized method of addressing the dispute as long as it can be accomplished within the allotted time period.
6. If consensus is reached, dispute resolution is terminated. The consensus agreement should be recorded in CMER meeting minutes and reported to the Policy Committee co-chairs.
7. If consensus is not reached in Stage 1, any Board approved CMER member may elevate the dispute to Stage 2.

*Policy*

1. As a body, the Policy Committee may have to conduct dispute resolution on technical issues or policy questions originating in CMER or policy issues that originate within the Policy Committee.

2. The Policy Committee has up to two months following formal initiation of dispute resolution to complete Stage 1.
3. The Policy Committee co-chairs should get disputes on the agenda as soon as possible after being informed that a member wishes to initiate dispute resolution.
4. Policy disputes originating in CMER will be framed and forwarded to the Policy Committee by the Administrator.
5. Policy Committee co-chairs should seek additional clarification from the CMER co-chairs when they are unclear of the nature of a policy dispute or the technical issues involved.
6. The initiation of dispute resolution should be recorded in the formal meeting minutes and the Board should be notified through the Administrator.
7. The Policy Committee co-chairs are responsible for setting up a dispute resolution discussion and can employ a variety or combination of methods to attempt to resolve the dispute. The method selected and the time period available for resolution should be announced to the Policy Committee via e-mail before the first meeting at which the dispute is scheduled to be discussed. The following are suggested methods for seeking resolution. Other methods not listed may be equally effective.
  - a. Placing the dispute on the agenda where it will be aired and the group will attempt to come to consensus through a normal chair facilitated discussion.
  - b. Asking for and distributing written discussions of the disputed issues and potential solutions from the party or parties requesting dispute resolution and response from those with opposing views. This exchange would have to be scheduled so that discussion leading to potential consensus could occur on time.
  - c. Asking an impartial volunteer from the group to mediate the dispute and facilitate an attempt to reach consensus.
  - d. Adding a fact-finding step to any one of the above methods to insure that the decision is properly informed on the issues of the dispute. Fact-finding would have to be scheduled so that discussion leading to potential consensus could occur on time.
  - e. Seeking outside technical advice.
  - f. Arranging for discussion outside of formal Policy Committee meetings to facilitate agreement among disputing parties.
  - g. Reaching consensus on a customized method of addressing the dispute as long as it can be accomplished within the allotted time period.
8. If consensus is reached within the Policy Committee, dispute resolution is terminated. The consensus agreement should be recorded in the formal summary of the Policy Committee meeting.
9. If consensus is not reached, any participating Policy Committee caucus may elevate the dispute to Stage 2.

Guidance for Dispute Resolution Stage 2 for CMER and the Policy Committee

1. Issues not resolved in Stage 1 are elevated to Stage 2 by a request from a Board approved CMER member or a Policy Committee caucus to the CMER or the Policy Committee co-chairs, respectively. The time period is initiated at the next regularly scheduled CMER or Policy Committee meeting or 30 days following the request, whichever is shorter. The initiation of Stage 2 dispute resolution must be recorded in the formal summary of the next meeting in which it was formally invoked.
2. Within one month of the initiation of Stage 2:
  - a. If within CMER, CMER must agree if technical disputes will be resolved through mediation or arbitration.

- b. If within the Policy Committee, the Policy Committee must agree if policy disputes require technical support through CMER and if resolution can be achieved through mediation or arbitration, with mediation being the default.
3. The Administrator should have a qualified individual with experience in natural resources dispute resolution and mediation and/or arbitration who is acceptable to all parties and available for the task on short notice.
4. The Administrator should assist the mediator or arbitrator as needed to:
  - Identify the disputed issue(s);
  - Introduce the parties; and
  - Set up meeting dates, times and location.
5. If consensus is reached within the Policy Committee or within CMER, dispute resolution is terminated. The consensus agreement must be recorded and distributed to the appropriate committee.
6. In the case of Stage 2 dispute resolution in CMER, CMER will follow its dispute resolution process as described in its Protocols and Standards Manual. Unresolved CMER issues will be forwarded to Policy. In the case of Stage 2 dispute resolution in Policy, if consensus is not reached, the Administrator will forward the issue(s) and relevant information to the Board.
7. Results of Stage 2 must be recorded in the official CMER and Policy Committee meeting summary.

## **PART 6. RELATED PROGRAM ELEMENTS**

### **6.1 Biennial Fiscal and Performance Audits**

Biennial fiscal and performance audits of the Adaptive Management Program are required by the forest practices rule, WAC 222-12-045(2)(e). The audits may be performed by DNR or other independent state agencies. However, the Administrator is responsible for ensuring the coordination of the development of these audits and reports. Both fiscal and performance audits will generally follow U.S. General Accounting Office auditing standards (GAO-03-673G), or other superseding standards issued by the Office of Financial Management (OFM), DNR, or other specific audit needs conveyed to the Administrator by the Board. Biennial performance audits will evaluate the goals, objectives, and key questions of the Adaptive Management Program.

### **6.2 Biennial/Compliance Monitoring**

Compliance monitoring is a necessary component of a scientifically credible adaptive management program. DNR through WAC 222-08-160(4) is directed to “provide statistically sound, biennial compliance audits and monitoring reports to the Board.” DNR designs and conducts compliance monitoring to determine how well the forest practice rules are being implemented on the ground. Compliance monitoring results will be reported to the Forest Practices Board, to CMER through the Adaptive Management Program Administrator, and to others as directed by the Board. Together with the products and recommendations of the Adaptive Management Program, compliance monitoring and reports will assist the Board in assessing if the goals of the Forest Practices Act and rules are being achieved.

**Appendix A Adaptive Management Program Ground Rules**

**Appendix B Framework for Successful Policy Committee/CMER Interaction**

**Appendix C Policy Committee Work Group Charter Template**

## Appendix A Adaptive Management Program Ground Rules

### I. TFW Policy Committee (WAC 222-12-045(2)(b)(ii))

Policy Committee members are self-selected by participating caucuses. Each caucus selects representatives to the Policy Committee and the Adaptive Management Program. Caucuses should be mindful of how their appointed representatives are perceived by other caucuses in light of the fact that the Adaptive Management Program is a collaborative effort. Each representative should demonstrate a genuine commitment to problem solving and mutual respect among all the caucuses. Since the Policy Committee is a collaborative forum, participation is dependent on adherence to the following ground rules:

#### A. Ground rules concerning expectations upon appointment as an Adaptive Management Program participant.

1. Participants in the Adaptive Management Program bring with them the legitimate purposes and goals of their organizations.
2. Participants recognize the legitimacy of the goals of others and assume that their own goals will also be respected.
3. Participants agree that the purpose of the Adaptive Management Program is the effective implementation of the Forest Practices Act and rules in order to meet its four goals (see Part 1, Overview).
4. Participants provide sufficient attention, staffing and other resources.
5. Participants commit to address all aquatic resource management issues raised in the adaptive management process.

#### B. Ground rules concerning participating in the Policy Committee and decision making.

1. The Policy Committee table welcomes representatives from nine caucuses, their designated alternates and those in senior leadership positions with a participating federal, state agency, tribal, county, landowner or environmental organization.
2. Decisions are made through consensus among the nine caucuses that make up the Policy Committee.
3. At each decision point for the Policy Committee, each caucus is encouraged to bring a single view to the table from their representative, alternate and senior leaders who are participating within the Policy Committee on that issue.
4. The Policy Committee will base consensus on one vote from each of the nine caucuses.
5. It is the responsibility of each caucus to foster consensus among their caucus members.
6. Staff members, guests and visitors are encouraged to attend meetings as they choose, but defer to those at the Policy Committee table for discussion and decisions.

#### C. Ground rules concerning participation in the Adaptive Management Program.

1. Participants commit to search for opportunities to solve problems collaboratively. Participants acknowledge that solving problems or issues of other caucuses is more likely to lead to solutions for ones own problems and issues.



2. Participants commit to listen carefully, ask questions to understand, and make statements to explain or educate.
3. Participants state needs, problems and opportunities first and positions last, and avoid hidden agendas.
4. If a caucus does not agree with statements or positions by other caucuses, participants offer reasons why and alternatives.
5. Participants attempt to reach consensus on a proposal or other issue being considered in the Adaptive Management Program. Consensus means that each caucus can live with all parts of that proposal, and that all caucuses will accept implementation of all parts of that proposal. At a minimum, each participant allows its name being subscribed on consensus proposals being sent to the Board, and to refrain from taking actions opposing adoption of consensus proposals by the Board.
6. Caucuses are polled on each proposal. Caucus positions on proposals reside with the governing bodies of each caucus's representatives. Each caucus decides how it will govern itself in reaching caucus decisions.
7. If the dispute resolution process concludes without consensus or a resolution satisfactory to each caucus, the issue or matter is released for consideration in other forums. If a participant chooses to resort to such other processes, it notifies the other participants before taking such action.

**D. Ground rules concerning relationships to outside parties and processes**

1. Participants avoid use of other processes such as legislation or litigation to resolve issues being considered in the Adaptive Management Program. If a participant believes it must resort to such other processes, it notifies the other participants before taking such action.
2. A participant may leave the Adaptive Management Program after telling the other caucuses why.
3. At the conclusion of an issue, participants attempt to agree on the message that will be given, and respect the resolution and implementing actions of the other participants.
4. No participant attributes suggestions, comments or ideas of another participant in communications with the news media or other non-participants.
5. Each participant accepts the responsibility to keep friends and associates informed of the progress of the Adaptive Management Program.
6. Caucuses are free to talk to the press, but they should not negotiate their positions in the press. Everyone is mindful of the effects their public and private statements will have on the climate of this effort.

**II. Cooperative Monitoring Evaluation and Research Committee (CMER) (WAC 222-12-045(2)(b)(i))**

**A. General CMER Ground Rules**

1. Each of the participants affirmed by the Board to CMER agree to these ground rules, which were developed collectively by CMER to ensure that CMER produces credible scientific results that have a broad base of support. These ground rules are specific to CMER and do not apply to any other portion of the Adaptive Management Program.

2. CMER core values are predicated upon the agreement of each CMER participant that adaptive management is based upon sound science. It is the responsibility of every participant to follow sound scientific principles and procedures.
3. Participants will also adhere to the purpose of the Adaptive Management Program:  
*. . . to provide science-based recommendations and technical information to assist the board in determining if and when it is necessary or advisable to adjust rules and guidance for aquatic resources to achieve resource goals and objectives. The goal of the program is to affect change when it is necessary or advisable to adjust rules and guidance to achieve the goals of the forests and fish report or other goals identified by the board. (WAC 222-12-045(1))*
4. Individual Policy Committee positions are not the basis for CMER decisions, otherwise the credibility of CMER research can be questioned, resulting in CMER having failed in its function of providing accountable results to the Adaptive Management Program.

**B. Specific CMER Ground Rules**

1. CMER participants will engage in actions that promote productive meetings and will encourage the active participation of each individual member. Examples of these actions are:
  - a. Speak to educate, listen to understand.
  - b. Pursue win/win solutions.
  - c. State motivations and justifications clearly. Discuss issues openly with all concerns on the table. Avoid hidden agendas.
  - d. Ensure that each individual has a chance to be heard.
  - e. Help others move tangent issues to appropriate venues by scheduling a time to discuss these issues later.
  - f. Start and stop meetings on time.
  - g. Take side conversations outside—listen respectfully.
  - h. Define clear outcomes for each conversation and appoint a conversation manager.
  - i. Be trusting and trustworthy.
  - j. Acknowledge and appreciate the contributions of others, even when you disagree.
2. CMER participants agree to spend the time in preparation for meetings so that their participation is both meaningful and relevant and to refrain from participation when they are unprepared.
3. CMER participants agree to participate in the Adaptive Management Program's scientific dispute resolution process when consensus cannot be reached and to make a good faith effort to resolve the dispute.
4. CMER participants recognize that information and results are preliminary until the final report is approved by CMER. Products must be clearly labeled and presented as DRAFT until approved by CMER as a final product.

5. At no time shall any potential contractor<sup>1</sup> for a project be involved in the drafting of an RFP, RFQ or SOW or in the selection of a contractor for that specific project.<sup>2</sup>

---

<sup>1</sup> For the purposes of this ground rule, “contractor” is defined as owner or employee of a private business and is restricted to those contracts identified as open to public bid. This is different from those tasks and contracts directed to CMER Staff, inter-agency agreements, and cooperative participation where availability, specialized knowledge and skills, timeliness, and advantage of in-kind contributions are deemed important to project success.

<sup>2</sup> *The intent of this ground rule is to comply with state law and DNR contracting procedures.* Chapter 19.36 RCW – Statute of Frauds; Chapter 39.19 RCW (see also Title 326 WAC)– Office of Minority and Women’s Business Enterprises; Chapter 39.29 RCW – Personal Services Contracts; Chapter 39.34 RCW– Interlocal Cooperation Act (Interagency Agreements); Chapter 40.14 RCW (WAC 434-635-010) – Destruction, Disposition of Official Public Records or Office files and Memoranda; Chapter 1.06 RCW – State Civil Service Law; Chapter 42.17 RCW (WAC 32-10-020 – 170) – Public Records; Chapter 42.53 RCW – State Ethics Law; OFM Regulation (chapter 3, Part 4, Section 1) – State of Washington Policies, Regulations, and Procedures; OFM Guide to Personal Service Contracting; DNR Policy Number P004-001 – Interagency Agreements and Memoranda of Understanding; and the DNR Contract Manual.

## **Appendix B Framework For Successful Policy/CMER Interaction**

The framework for the Adaptive Management Program rests in the four goals articulated in the Forests and Fish Report (FFR). These goals are:

1. To provide compliance with the Endangered Species Act for aquatic and riparian-dependent species on non-federal forest lands;
2. To restore and maintain riparian habitat on non-federal forest lands to support a harvestable supply of fish;
3. To meet the requirements of the Clean Water Act for water quality on non-federal forest lands; and
4. To keep the timber industry economically viable in the State of Washington.

These four goals provide the balance necessary for sustaining the FFR. Each goal must be considered when considering how to act on results of CMER studies.

The Forests and Fish Report, while based on science, also recognized there is still scientific uncertainty concerning how forested ecosystems function within the framework of managed forests and how various ecosystem components relate to one another. Scientists and policy-makers agree that because ecosystems are complicated, we can increase our scientific knowledge over time, but we may never fully understand the complex relationships that occur within ecosystems. Though stakeholders recognize uncertainty, it is important that overall performance goals are met by the forest practices rules and that adaptive management research helps to inform policy makers as to whether these goals are being met or not. The overall performance goal agreed to in FFR is that forest practices, either singly or cumulatively, will not significantly impact the capacity of aquatic habitat to: a) support harvestable levels of salmonids; b) support the long term viability of other covered species; or c) meet or exceed water quality standards (protection of designated uses, narrative and numeric criteria, and antidegradation). The Adaptive Management Program is designed to develop additional scientific knowledge and to better inform policy makers about the relationship of managed forests and ecosystem and riparian functions and specifically regarding how well the rules are meeting performance goals.

Since Adaptive Management will provide science-based and technical information for policy-makers, it is critical for Forest Practices Board members and Policy to understand the implications of research being conducted within the Adaptive Management Program and overall policy framework and goals.<sup>1</sup> One important aspect of this is to understand the purpose of the study and the types of results that may emerge. Policy makers must also understand that study results can be significant or insignificant and/or may be stand-alone or linked to completion of other studies.

---

<sup>1</sup> WAC \*222-12-045 defines the purpose of adaptive management as follows:

(1) **Purpose:** The purpose of the program is to provide science-based recommendations and technical information to assist the Board in determining if and when it is necessary or advisable to adjust rules and guidance for aquatic resources to achieve resource goals and objectives. The Board may also use this program to adjust other rules and guidance. The goal of the program is to affect change when it is necessary or advisable to adjust rules and guidance to achieve the goals of the forests and fish report or other goals identified by the Board. There are three desired outcomes: Certainty of change as needed to protect targeted resources; predictability and stability of the process of change; and application of quality controls to study design and execution and to the interpreted results.

FFR stakeholders agreed to resource objectives and performance targets for the following functions: heat/water temperature, LWD/organic inputs, sediment, hydrology, and chemical inputs.

It is important for the success of the adaptive management program that policy makers are able to make timely and informed decisions based on CMER research and within the clear policy framework and goals established by FFR and codified in rules. The framework below is designed to assist policy makers in keeping informed about ongoing CMER research and will provide a basis for decision-making when studies are completed.

First, there is a series of questions leading to a Policy adaptive management recommendation to the Forest Practices Board (Table 1). These questions should be answered for all CMER studies and for any other study that any organization advances to Policy as the basis for an adaptive management recommendation. These questions may be broken into two groups. There are six questions that should be answered about each study as it is initiated (preferably) or when it is presented for use in decision making (if the questions were not answered when the study was initiated). These are scientific questions that should be answered by CMER. Detailed guidance on how these questions are answered are available in the Adaptive Management Program Manual. Then, there are four questions that should be answered after CMER has delivered the study report and the answers to the first six questions to Policy. These are management questions that should be answered by Policy.

The answers to these questions will help policy makers with decision making when studies are completed. For example, if the study is part of a larger program, policy makers may decide to wait until all results are in before making decisions about proposing rule changes or seeking other alternative strategies to address management objectives.

Timeliness is an important consideration in Policy's decision making. The forest practices rules state "Upon receipt of the CMER report, policy will prepare program rule amendments and/or guidance recommendations in the form of petitions for amendment. When completed, the Administrator will forward the petitions and the original CMER report and/or other information as applicable, to the Board for review and action. Policy recommendations to the board will be accompanied by formal petitions for rule making" (WAC 222-12-045(2)(d)(vi)). Stage two of the Adaptive Management dispute resolution process (mediation/arbitration) can be invoked six months after CMER has delivered its report to Policy, if Policy has not made its recommendations to the Forest Practices Board (Board). To promote timely decision making, Table 2 outlines a timeline for Policy to answer questions #7, #8, #9, and #10 (see Table 1) and submit its recommendations to the Board.

**Table 1. Questions leading to a Policy adaptive management recommendation to the Forest Practices Board**

CMER	relevance	1. Does the study inform a rule, numeric target, performance target, or resource objective? <sup>2</sup>
		2. Does the study inform the forest practices rules, the Forest Practices Board Manual guidelines, or Schedules L-1 or L-2?
	quality	3. Was the study carried out pursuant to CMER scientific protocols (i.e., study design, peer review)?
		4. What does the study tell us? What does the study not tell us?
	completeness	5. What is the relationship between this study and any others that may be planned, underway, or recently completed? Factors to consider in answering this question include, but are not limited to: <ul style="list-style-type: none"> <li>a. Feasibility of obtaining more information to better inform Policy about resource effects.</li> <li>b. Are other relevant studies planned, underway, or recently completed?</li> <li>c. What are the costs associated with additional studies?</li> <li>d. What will additional studies help us learn?</li> <li>e. When will these additional studies be completed (i.e., when will we learn the information?</li> <li>f. Will additional information from these other studies reduce uncertainty?</li> </ul>
		6. What is the scientific basis that underlies the rule, numeric target, performance target, or resource objective that the study informs? How much of an incremental gain in understanding do the study results represent?
Policy	options	7. Should any action be taken at this time, in response to the information that CMER has provided?
		8. What are the alternative courses of action, each of which would be an appropriate management response to the information that CMER has provided?
		9. How feasible is each alternative from operational and regulatory perspectives?
	decision	10. Will Policy make a consensus, adaptive management recommendation to the board? If so, which alternative will Policy recommend?

<sup>2</sup> FFR stakeholders agreed to resource objectives and performance targets for the following functions: heat/water temperature, LWD/organic inputs, sediment, hydrology, and chemical inputs.

**Table 2. Timeline for Policy to answer key adaptive management questions and submit its recommendations to the Forest Practices Board**

Day	Action
0	Adaptive Management Administrator delivers CMER's report to Policy including the answers to questions #1, #2, #3, #4, #5, and #6 (see Table 1).
45	Policy answers question #7.
105	Policy answers question #8 and #9.
150	Policy answers question #10. If Policy has agreed upon an alternative, Policy begins to draft its recommendations to the Board. If Policy has not agreed upon an alternative, Policy decides whether to invoke Stage Two of the adaptive management dispute resolution process or forward relevant materials directly to the Board.
180	If Policy has agreed upon an alternative, Policy finalizes its recommendations and gives them to the Adaptive Management Administrator for delivery to the Board. If Policy has not agreed upon an alternative, Policy either invokes Stage Two of the adaptive management dispute resolution process or gives relevant materials to the Adaptive Management Administrator for delivery to the Board.
270	(if Policy has invoked Stage Two of the dispute resolution process) If dispute resolution is successful, Policy has selected an alternative and begins to draft its recommendations to the Board. If Stage Two is unsuccessful, Policy begins to assemble the materials described in WAC 222-12-045(2)(h)(ii)(C).
300	Policy submits either its recommendations (dispute resolution successful) or other materials (dispute resolution unsuccessful) to the Board.

Adaptive management alternatives and recommendations considered by Policy may work at two different levels (Table 3). "Rule tool" studies and effectiveness monitoring normally influence prescriptions. However, in order to meet all four goals of the forest practices rules, it may sometimes be necessary to consider changes to performance targets in response to these types of studies. Changing performance targets in response to rule tool studies will be considered only if it can be shown that the resource objectives will still be met.

**Table 3. Hierarchical relationship of prescriptions and performance targets with respect to forest practices adaptive management decisions.**

adaptive management decision space			management hierarchy
“rule tool” studies	effectiveness monitoring	validation studies	
normal	normal	n/a	prescription (e.g., 50 foot no-harvest core zone)
			↑
only if it can be shown that the resource objectives will still be met	possible	normal	performance target (e.g., shade available within 50 feet for at least 50% of stream length)

The second element of this framework recognizes that ongoing Policy interaction with CMER is critical to making adaptive management a successful program. Policy makers should be informed early about potential study results, especially if these results are likely to be scientifically significant and/or lead to significant changes in policy. To facilitate this communication, Policy will devote at least one hour at each of its monthly meetings to discuss ongoing studies and the potential implications of these studies, particularly within the context of overall policy goals and framework of the FFR and the Forest Practices Act. At these monthly meetings, Policy may create ad hoc groups, as needed, to consider various adaptive management topics and/or assist the Adaptive Management Administrator.



## **Appendix C Policy Work Group Charter Template**

The following template is provided as a standard for developing Policy work group charters. Once the charter elements have been prepared, the charter must be agreed to by the work group participants and endorsed by Policy.

### **Title**

Project Name

Date

### *I. Introduction*

Provide a brief project overview, the need for this charter, and the function of the Policy work group in meeting that need.

### *II. Define the Policy Work Group*

- Membership – Identify the participants on the group by name and affiliation. As necessary, identify the different roles and responsibilities such as co-chairs, recorders, observers, etc.
- Purpose – Define the scope and objectives of the work group. Define any boundaries or limitation of participation by the work group.
- Tasks & Responsibilities – Identify the tasks and duties the work group will need to accomplish to meet the project objectives
- Deliverables - Identify the specific deliverables the work group will need to provide to meet the project objectives
- Group Process, Reporting, and Support – Describe how the group will function, its reporting structure back to Policy, and what support is needed to accomplish project objectives.
- Adaptive Management Program Ground Rules – Attach for each work group member to have and to follow.

### *III. Timeline*

Provide an estimated timeline by deliverables and/or process milestones for review.

## **Section 23**

# **Guidelines for Field Protocol to Locate Mapped Divisions Between Stream Types and Perennial Stream Identification**

This section is under development.

**Section 24**  
**Guidelines for the Interim**  
**Modification of Bull Trout Habitat Overlay**

This section is under development.

## **Section 25**

# **Guidelines for Bull Trout Presence Survey Protocol**

This section is under development.

## Section 26

### Guidelines for Large Woody Debris Placement Strategies

<b>PART 1. INTRODUCTION.....</b>	<b>1</b>
FOREST PRACTICES HYDRAULIC PROJECTS (FPHP) .....	1
OFF-CHANNEL HABITAT ENHANCEMENT AND OTHER TYPES OF ENHANCEMENT .....	2
<b>PART 2. STANDARD LWD PLACEMENT GUIDELINES .....</b>	<b>2</b>
PLANNING .....	2
PREFERRED LOCATIONS .....	2
CHANNEL CONFIGURATION A.....	2
CHANNEL CONFIGURATION B .....	3
CHANNEL CONFIGURATION C .....	3
CHANNEL CONFIGURATION D.....	3
THE CRITERIA FOR WOOD PLACEMENT .....	3
PREFERRED PLACEMENT OF WOOD SPECIFICATIONS AND STRATEGIES .....	4
LOGJAMS AND MAXIMUM LOADING .....	4
<b>PART 3. EASTERN WASHINGTON .....</b>	<b>5</b>
<b>PART 4. CREDIT SYSTEM.....</b>	<b>6</b>
CLAIMING CREDIT .....	6
SURPLUS CREDIT .....	6
DONATIONS .....	6
CLAIMING CREDIT - CALCULATION OF PLACED LWD.....	6
COLLECTING CREDIT – CALCULATION OF OUTER ZONE TREES.....	6
CREDIT RATIO .....	6
<b>REFERENCES.....</b>	<b>7</b>
<b>APPENDIX A LWD PLACEMENT AND CREDIT CALCULATION WORKSHEET .....</b>	<b>8</b>

#### **PART 1. INTRODUCTION**

This manual provides the technical guidance for in-channel wood placement. Large woody debris (LWD) placement can be accomplished using this manual or with an approved alternate plan (**WAC 222-12-040**). The intent is to facilitate long-term fish habitat development in streams located in managed forestlands by creating incentives for landowners to place wood. Credit for LWD placement is given in the form of harvest of additional Riparian Management Zone (RMZ) outer zone trees (**WAC 222-30-021(1)(c)(iii)** and **WAC 222-30-022(1)(c)(ii)**). Most managed forestland streams in Western Washington, and many managed forestland streams in Eastern Washington are currently deficient in LWD as a result of historic riparian harvest practices, splash damming, and stream clean-out activities. Although LWD placement provides relatively short-term habitat benefits, timber harvest in the RMZ outer zone exchanged for LWD placement in fish habitat streams may provide incentives for landowners to improve fish habitat until mature trees can contribute naturally.

#### Forest Practices Hydraulic Projects (FPHP)

An approved FPA for a forest practices hydraulic project (FPHP) is required for all in-channel LWD placements. FPHPs regulate construction or other activities that “use, divert, obstruct, or change the natural flow or bed of any Type S, F, or N Waters” (**WAC 222-16-010**). Landowners

are encouraged to consult with the Department of Natural Resources (DNR) and the Department of Fish and Wildlife (WDFW) prior to submitting an application involving a FPHP to help ensure that project plans and specifications meet fish protection standards. See Board Manual Section 5, *Guidelines for Forest Practices Hydraulic Projects* for more information regarding LWD placement.

LWD placement will usually be done in conjunction with a harvest site and associated Forest Practices Application (FPA). FPAs may also be required for fish enhancement groups that fell trees and place LWD as part of a cooperative effort with the landowner. Enhancement groups should contact the DNR region office to determine if one is appropriate. **See paragraph on Donations below.**

#### Off-channel habitat enhancement and other types of enhancement

It is anticipated that most enhancement activities will be in the form of un-anchored wood placement, which is addressed in detail below. However, where the appropriate opportunities exist, off-channel habitat restoration opportunities are encouraged by WDFW. These opportunities are site-specific in nature. Consultation with DNR and WDFW is required to determine the amount of basal area credit.

## **PART 2. STANDARD LWD PLACEMENT GUIDELINES**

Refer to Appendix A, LWD Placement and Credit Calculation Worksheet.

### Planning

Watershed scale planning is highly encouraged to identify preferred locations for LWD placement. Landowners should consult with tribal and WDFW habitat biologists to identify preferred locations as well as undesirable locations. The use of watershed analyses, Habitat Conservation Plans (HCPs) and other habitat assessment and habitat restoration planning documents may be helpful in this regard. At minimum, the following locations should be avoided:

1. Channels that have a history of, and a near-future likelihood of debris torrents and other mass wasting activity.
2. Locations immediately above permanent culverts
3. Confined channels where the valley floor width is less than twice the bankfull width. See Board Manual Section 2 for identifying Channel Migration Zones and bankfull channel features.

### Preferred Locations

LWD placement is limited to Type S or F Waters. Among those sites that are appropriate, different restrictions or levels of consultation may be necessary. The chart below (modified from ODF and ODFW 1995) identifies four “Channel Configurations”, which represent ranges of channel gradient and bankfull width. Different placement criteria and procedures apply to different channel configurations.

### Channel Configuration A

This is the preferred channel configuration for LWD placement. LWD can be placed provided that the LWD placement protocol described herein is followed. If an insufficient number of

credit trees (see paragraph on “credit” below) are available from the outer zone of the harvest unit, the landowner may choose to place more LWD in the channel and harvest outer zone credit trees from concurrent and/or future harvest units in the same Watershed Analysis Unit (WAU) (see paragraph on “surplus credit” below). The LWD placement and credit calculation worksheet, below, may be used to calculate credit and track the collection of surplus credit for subsequent harvest sites. LWD may be placed up to the maximum allowed in the paragraph on “logjams and maximum wood loading” below.

#### Channel Configuration B

Configuration B is used for a set of channel conditions that are intermediate in their desirability as sites for wood placement. Stand composition is used as the decision criteria for determining the desirability of wood placement for these conditions, and therefore the procedures to follow for placing wood. If the combined basal areas of core and inner zones are dominated by deciduous trees (i.e.  $\geq 70\%$ ) then follow the procedures used for Channel Configuration A. Otherwise, follow the wood loading limits and other procedures for Channel Configuration C.

#### Channel Configuration C

This is not a preferred channel configuration for wood placement. Credit trees for LWD placement may only be taken from the adjacent outer zone of the riparian buffer, which places a tight limit as to how much wood can be placed. In other words, there will be no surplus credit granted so that outer zone trees can be taken from other harvest units. Additional wood can be placed only if the operator receives approval from DNR, in consultation with the WDFW area habitat biologist.

#### Channel Configuration D

If a landowner wants to create an in-channel fish habitat enhancement project, this must be done with an alternate plan (**WAC 222-12-040**). The plan will include engineering designs and rationale on why placement is superior to retaining trees in the outer buffer. LWD without sufficient diameter or attached root wads are not likely to qualify for credit. Stream channels wider than 40 feet bankfull width fall within the Channel Configuration D.

#### The criteria for wood placement

**Minimum wood length:** Logs to be placed must be a minimum of twice BFW and meet a minimum diameter as specified below. Placement logs with root wads attached must be a minimum 1.5 times diameter BFW and meet a minimum diameter as specified below. (ODF and ODFW 1995 and watershed analysis).

**Minimum wood diameter:** Placement piece diameters must meet or exceed diameters listed in the table below. Diameters of placed pieces are measured at the widest diameter of the bole within the banks. If root wads are placed within the channel, diameters are measured at an approximate equivalent location to breast height as if it were standing.

<b>BFW in feet</b>	<b>Minimum Diameter</b>
< 5	12 inch diameter
> 5 and < 16	16 inch diameter
>16 and < 32	22 inch diameter
> 32	26 inch diameter

**Type of wood and quality:** All wood placed for credit must be conifer. Larch, cedar and Douglas fir are preferred because they will provide stability over a longer period of time. Credits will only be provided for LWD that is freshly cut or from downed wood that has a solid rot-free core. Measure the solid rot-free core for credit diameter if the wood in the piece is not from a live tree. If downed logs or root wads are taken from an upland source, it must not compromise downed log requirements for wildlife (**WAC 222-30-020(11)**).

Preferred Placement of Wood Specifications and Strategies

It is recommended that an experienced biologist be consulted on wood placement. There are a number of strategies that can or should, be applied depending on the width and gradient of the stream. At the very least, it is recommended that boles (trunk of the tree) should be partially in the water and partially on the bank. Root wads should be placed entirely within the bankfull width.

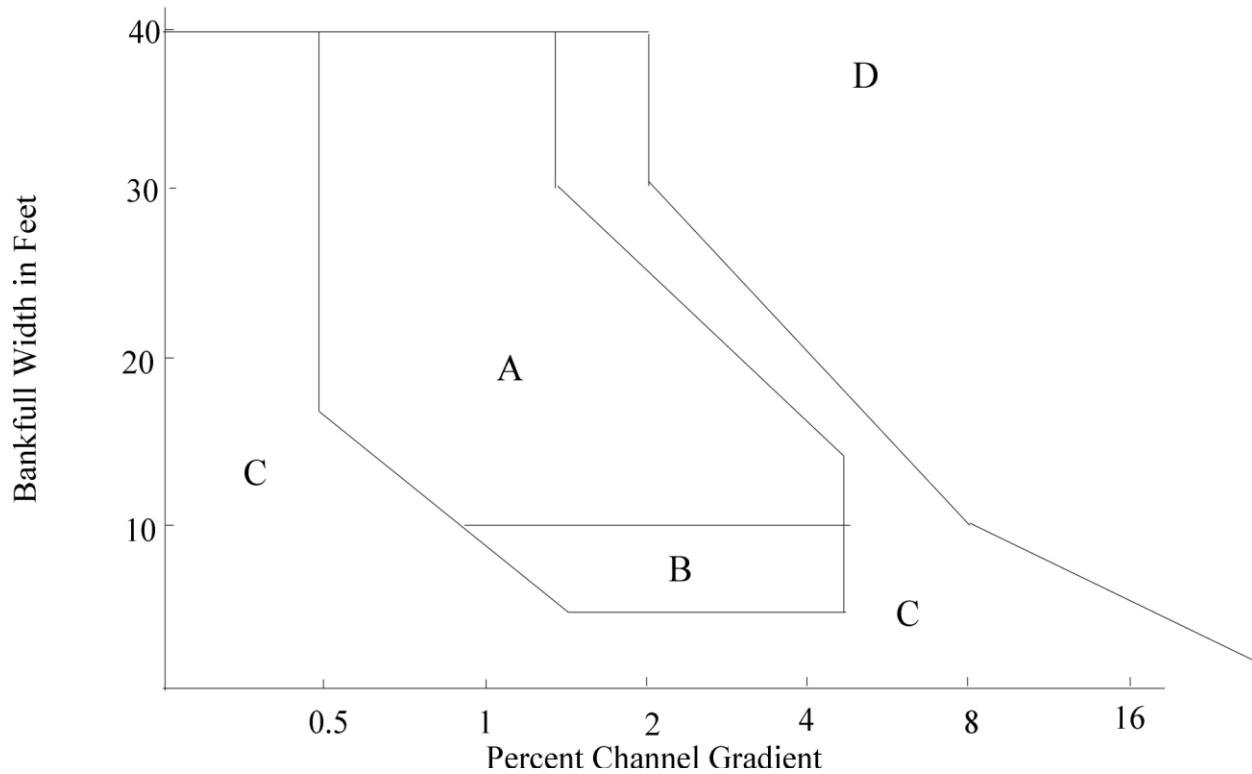
Logjams and Maximum Loading

Operators are encouraged to place multiple pieces of LWD into logjam formations on wider streams, even if this causes a concentration of placed LWD in a few locations within a stream segment or harvest unit. However, there are some limits as to how much LWD can be packed into short segments of streams. Placed logjams must be spaced, at a minimum of 1 – 3 bankfull widths apart, and should not exceed the number of LWD (this includes both natural recruitment and placed LWD) indicated in the table below.

<b>BFW in feet</b>	<b>Maximum number of LWD per logjam</b>
< 5	2 pieces
> 5 and < 16	5 pieces
>16 and < 32	12 pieces
> 32	15 pieces



## Preferred Channel Configurations for LWD Placement



**Restrictions to Riparian Zone Disturbances.** Ground disturbance should be minimized and limited to areas necessary for placement access. Ground disturbance should be limited to 5% of the length of the stream reach in the harvest unit or area of the proposed activity when placing LWD. Use of helicopter, cable, and tracked-excavator systems for wood-placement is strongly encouraged. Use of crawler tractor or rubber-tired skidder is strongly discouraged as a method to place logs in streams, due to expected ground disturbance and limited ability for desired placement. Disturbed soils with the potential to erode into the stream should be treated with erosion control measures available and appropriate for the site. Applicants are not responsible for bank erosion and scour that occurs in response to LWD placement.

### PART 3. EASTERN WASHINGTON

One half of the outer zone leave trees may be harvested as credit for LWD placement, as long as the remaining half are left in the outer zone. Thus, up to 10 trees, 8 trees and 5 trees per acre may be harvested in the High Elevation habitat type, the mixed conifer timber habitat type, and the Ponderosa pine timber habitat type, respectively. Minimum diameters and placement frequency for LWD has not been determined for eastside streams. Until additional data is available, the minimum LWD size and placement frequency will be the same as Western Washington criteria.

## **PART 4. CREDIT SYSTEM**

Credit accrued from placement of LWD can only be used to harvest trees from the outer zone. Refer to the LWD Placement and Credit Calculation Worksheet below.

### **Claiming Credit**

Credit can be claimed whenever LWD placement activity takes place under channel configurations A-C. Channel Configuration D projects and off channel enhancement will require an alternate plan.

### Surplus Credit

Where wood is placed to the maximum allowable number of pieces in a given channel segment, surplus credit may apply to other harvest units within the same WAU.

### Donations

Landowners may also claim credit for donating wood to volunteer and funded enhancement efforts that occur in managed forestlands, provided that the provisions of this manual are followed.

### Claiming Credit - Calculation of placed LWD

Credit for placed logs will be cross-section area of the piece calculated from diameter measured at the widest point that lies within the bankfull width. When root wads are placed in the channel, diameter will be measured at “dbh”, as if the root wad were a standing tree (i.e. 4.5 feet above the estimated ground level). If the root wad portion of the placed log is outside the channel, credit diameter will be the same as for a log.

### Collecting Credit – Calculation of outer zone trees

For purposes of calculating basal area credit, it is assumed that outer buffer leave trees will average 15” dbh or 1.23 square feet of basal area each. This holds true for both eastern and western Washington.

### Credit ratio

When enhancement logs are placed in Type S or F Waters (per **WAC 222-30-021(1)(c)(iii)**), landowners will be credited two units of harvest basal area for every one unit of cross-section area placed in the stream, i.e., a **2:1 credit ratio**. When enhancement logs are placed in response to compensation for roads within the riparian zone, as per (**WAC 222-30-021(1)(b)(iii)** and **WAC 222-30-022(1)(b)(iv)**), landowners will be credited one unit of harvest basal area for every one unit of cross-section area placed in the stream i.e. a **1:1 credit ratio**.

## **References**

Cederholm, CJ, LG Dominguez and TW Bumstead. 1997. In PA Slaney and D. Zaldokas, eds. Fish Habitat Rehabilitation Procedures. Watershed Restoration circular No. 9. Ministry of Environment, Lands and Parks. Vancouver, BC.

[ODF and ODFW 1995] Oregon Dept. of Forestry and Oregon Dept. of Fish and Wildlife. 1995. A Guide to Placing Large Wood in Streams. ODF, Salem, OR. 31 pp.

Schuett-Hames, D., A. Pleus, L. Bullchild and S. Hall. 1994. Ambient Monitoring Program Manual. Northwest Indian Fish Commission, Olympia. TFW-AM94-001.

Slaney PA and D. Zaldokas, eds. 1997. Fish Habitat Rehabilitation Procedures. Watershed Restoration circular No. 9. Ministry of Environment, Lands and Parks. Vancouver, BC.

[WFPB, 1995] Washington Forest Practices Board. 1995. Board Manual: Standard Methodology for Conducting Watershed Analysis.

**Appendix A LWD Placement and Credit Calculation Worksheet**

To receive LWD credit, a copy of this work sheet must be submitted as part of your Forest Practices application/notification.

**STEP 1.**

Determine Average Bankfull Width in the channel reach within the harvest unit for the fish-bearing stream. See board manual, Section 2. If there is more than one fish-bearing stream within a harvest unit, determine average bankfull width for each stream independently. Where multiple stream segments exist within one harvest unit, average BFW may need to be computed for each segment. **Average BFW** \_\_\_\_\_

**STEP 2.**

**Determine minimum large woody debris (LWD) size.** The minimum diameter for wood by finding the appropriate BFW on the following chart:

<b>BFW (in feet)</b>	<b>Minimum Diameter</b>
< 5	12 inch diameter
> 5 and < 16	16 inch diameter
>16 and < 32	22 inch diameter
> 32	26 inch diameter

**Minimum Diameter:** \_\_\_\_\_

**Determine minimum length of placed bole 2 X BFW =** \_\_\_\_\_

**Determine minimum length of placed rootwad 1.5 X BFW =** \_\_\_\_\_

**STEP 3.**

Select logs/trees for placement:

- \_\_\_ Are they conifer?
- \_\_\_ Do they have a solid core?
- \_\_\_ Do they meet minimum diameter?
- \_\_\_ Do they meet minimum length?
- \_\_\_ Can they be transported to the site without excessive disturbance? (See “Restrictions to Riparian Zone Disturbances”)
- \_\_\_ Does site placement exceed in stream loading criteria ? (see “Logjams and Maximum Loading”)

**IF wood is being placed in Channel Configurations C or non-deciduous B, or placing wood to compensate for a basal area deficit due to a stream-adjacent parallel road, skip to STEP 7.**

**IF wood is being placed in Channel Configurations A or Deciduous B, go to STEP 4.**

**STEP 4.**

Determine placement of logs and measure their widest diameter within bankfull width. In-channel rootwads are measured at a location equivalent dbh if it were standing (i.e., 4.5 feet from the ground). Tally diameters in table below to the nearest two-inch size category.

dbh	Tally	Number (add up tally)	Basal Area	Credit (Number X Basal Area)
12			.8	
14			1.1	
16			1.4	
18			1.8	
20			2.2	
22			2.6	
24			3.1	
26			3.7	
28			4.3	
30			4.9	
32			5.6	
34			6.3	
36			7.1	
38			7.9	
40			8.7	

SUM \_\_\_\_\_

**STEP 5.**

Compute Basal Area.

Multiply the “number” column with the “Basal Area” column, and record the number in the “credit” column. Sum the last column.

Multiply the (SUM) from Step 4 by the credit ratio to get basal area credit. The credit ratio is 2.0 for standard LWD placement and 1.0 for placement associated with a stream adjacent parallel road. (See Credit Ration above).

**TOTAL BASAL AREA CREDIT** \_\_\_\_\_

**STEP 6.**

Credit taken.

Where outer zone trees are to be harvested under 2:1 credit ratio, assume that all outer zone trees are 15 inches in diameter or a basal area of 1.23 sq feet.

**Total number of trees available for harvest:**

**Total Basal Area Credit/1.23 = \_\_\_\_\_**

(Round to the nearest whole number)

If the site is a Channel Configuration C, D, or non-deciduous B, credit trees may only be harvested from the adjacent harvest site. The total number of trees computed above may be harvested from the RMZ outer zone within the harvest unit, provided that a minimum of 10 TPA is retained in the outer zone.

If the site is a Channel Configuration A or Deciduous-dominated B, credit trees may be harvested from other sites. Keep track of the Basal Area Credit on the following worksheet. On each harvest site from which credit trees are harvested, record the FPA number, the number of outer zone trees taken, and complete the remaining balance of credit trees. Once again, a minimum of 10 TPA must be retained in the outer zone.

Copies of this credit sheet should be submitted with each FPA

FPA number	# trees harvested	Balance remaining

**STEP 7.**

The following steps reverse the sequence used in steps 4-6 because the landowner needs to determine how much LWD cross-sectional area is needed first. The landowner can then place the appropriate LWD cross-sectional area in the streams.

**STEP 7A.**

If you are placing wood in Channel Configurations C or non-deciduous B, then:

1. Determine **Length** of outer zone from field measurements.
2. Determine **Width** of outer zone. Use table in **WAC 222-30-021 (b)(I)** entitled Option 1: Thinning from below for western Washington. Use either tables in **WAC 222-30-022** for eastern Washington RMZs depending on the width of the stream.
3. Determine minimum **LWD cross sectional area** to achieve full LWD placement credit for the harvest site.

$$\text{Cross Sectional Area (sq ft)} = \text{Length} * \text{Width} * 0.000141$$

For WESTERN WASHINGTON and High elevation habitats in EASTERN WASHINGTON it is (enter length and width):

$$\text{Cross Sectional Area} = \underline{\hspace{2cm}} * \underline{\hspace{2cm}} * \mathbf{0.000141}$$

For mixed conifer timber habitat types in EASTERN WASHINGTON:

$$\text{Cross Sectional Area} = \underline{\hspace{2cm}} * \underline{\hspace{2cm}} * \mathbf{0.000106}$$

For ponderosa pine timber habitat types in EASTERN WASHINGTON:

$$\text{Cross Sectional Area} = \underline{\hspace{2cm}} * \underline{\hspace{2cm}} * \mathbf{0.000076}$$

$$\text{Cross Sectional Area} = \underline{\hspace{4cm}}$$

[*Computational Basis:*  $\text{Cross Sectional Area} = L * W * X * T * BA * CR$

Where  $L = \text{length (feet)}$

$W = \text{width (feet)}$

$X = \text{Inverse sq ft per acre. Constant at } 1/43560$

$T = \text{allow harvest of outer zone trees per acre}$

(This is constant at 10, except in eastern Washington.)

$BA = \text{Basal Area. Outer zone trees are assumed to have } 1.23 \text{ sq ft of basal area.}$

Constant at 1.23

$CR = \text{Inverse Credit ratio. Constant at}$

$$X * T * BA * CR = (1/43560) * 10 * 1.23 * ( \quad ) = 0.000141 \quad ]$$

**STEP 7B.**

If you are placing LWD to compensate for a basal area deficit as a result of a stream adjacent parallel road, determine the basal area deficient (Cross Sectional Area):

$$\text{Cross Sectional Area Deficient} = (\text{required basal area}) - (\text{actual basal area})$$

$$\text{Cross Sectional Area Deficient} = \underline{\hspace{2cm}} - \underline{\hspace{2cm}} = \underline{\hspace{2cm}}$$

See **(WAC 222-30-021(1)(b)(iii))** for details in Western Washington and **(WAC 222-30-022(1)(b)(iv))** for details in Eastern Washington.

**STEP 8.**

Place wood meeting minimum size requirements as computed in STEP 2. Remember that the diameter is based on the widest section of the bole (trunk) within the banks. Once the Cross Sectional Area computed in STEP 7A or 7B above is reached, additional placement cannot receive additional credit.